

VE Series Smart Camera

Instruction Manual

Original Instructions
191666 Rev. K
8 February 2021
© Banner Engineering Corp. All rights reserved



191666

Contents

1 Product Description	6
1.1 Models	6
2 Overview	8
2.1 Features	8
2.1.1 Display	8
2.1.2 Indicators	8
2.1.3 Buttons	8
2.2 Vision Manager Software	9
3 Specifications and Requirements	10
3.1 Specifications	10
3.2 PC Requirements	10
3.3 Dimensions	11
3.4 Banner Engineering Corp. Software Copyright Notice	12
3.5 Additional Copyright Information	12
3.6 Trademarks	12
4 Installation Instructions	13
4.1 Install the Accessories	13
4.2 Mount the Sensor	13
4.3 Connect the Cables	14
4.3.1 Wiring Diagrams	15
4.4 Install the Software	16
5 Getting Started	17
5.1 Connect to the Sensor	17
5.2 Acquire a Good Image	18
5.3 Set Up an Inspection	18
5.3.1 Add a Tool	18
5.3.2 Rename a Tool	19
5.3.3 Name an Inspection	20
5.3.4 Save an Inspection to a Computer, Network Drive, or Storage Device	20
5.3.5 Modify a Currently Running Inspection	21
5.3.6 Copy a Tool	21
5.3.7 Delete a Tool	21
5.3.8 Delete a Tool and All Tools After It	21
5.3.9 Delete an Inspection	21
5.4 Configure the Discrete I/O	22
6 Vision Manager Workspace	23
6.1 Home Screen	23
6.1.1 Sensor Neighborhood	24
6.1.2 Sensor Maintenance	25
6.1.3 Emulators	27
6.1.4 User Preferences	28
6.1.5 About	28
6.2 Sensor Screen	28
6.2.1 Image Pane Parameters	29
6.2.2 Summary Pane	29
6.2.3 Tools & Results	31
6.2.4 Tools Only	32
6.2.5 All Results	32
6.3 Inspection Logs Screen	33
6.3.1 Log Sources	33
6.3.2 Loaded Logs	34
6.4 Inspection Management Screen	34
6.4.1 Manage	35
6.4.2 Transfer	36
6.5 System Settings Screen	37
6.5.1 Sensor Info	37
6.5.2 Discrete I/O	38
6.5.3 Communications	40
6.5.4 Logs	45
6.5.5 Units	46
6.5.6 User Profiles	54
6.5.7 System Reset	56
7 Using the Camera Tool	57

7.1 Imager	57
7.2 Trigger	58
7.3 Focus Information	59
7.4 External Strobe	59
7.5 Camera Tool: Results	60
8 Using the Inspection Tools: Vision Tools	61
8.1 Average Gray Tool	61
8.1.1 Average Gray Tool: Input Parameters	61
8.1.2 Average Gray Tool: Test Parameters	63
8.1.3 Average Gray Tool: Results	64
8.1.4 Using the Average Gray Tool	64
8.2 Bead Tool	65
8.2.1 Bead Tool: Input Parameters	65
8.2.2 Bead Tool: Test Parameters	70
8.2.3 Bead Tool: Results	70
8.2.4 Bead Tool: Adjust the ROI	71
8.2.5 Using the Bead Tool	73
8.3 Blemish Tool	75
8.3.1 Blemish Tool: Input Parameters	76
8.3.2 Blemish Tool: Test Parameters	78
8.3.3 Blemish Tool: Results	79
8.3.4 Using the Blemish Tool	79
8.4 Blob Tool	80
8.4.1 Blob Tool: Input Parameters	81
8.4.2 Blob Tool: Test Parameters	85
8.4.3 Blob Tool: Results	85
8.4.4 Using the Blob Tool	89
8.5 Circle Detect Tool	91
8.5.1 Circle Detect Tool: Input Parameters	91
8.5.2 Circle Detect Tool: Test Parameters	94
8.5.3 Circle Detect Tool: Results	95
8.5.4 Using the Circle Detect Tool	96
8.6 Edge Tool	98
8.6.1 Edge Tool: Input Parameters	98
8.6.2 Edge Tool: Test Parameters	104
8.6.3 Edge Tool: Results	104
8.6.4 Using the Edge and Measure Tools	105
8.7 Line Detect Tool	106
8.7.1 Line Detect Tool: Input Parameters	107
8.7.2 Line Detect Tool: Test Parameters	110
8.7.3 Line Detect Tool: Results	110
8.7.4 Using the Line Detect Tool	111
8.8 Locate Tool	112
8.8.1 Locate Tool: Input Parameters	112
8.8.2 Locate Tool: Test Parameters	118
8.8.3 Locate Tool: Results	119
8.8.4 Using the Locate Tool	120
8.9 Match Tool	122
8.9.1 Match Tool: Input Parameters	123
8.9.2 Match Tool: Test Parameters	126
8.9.3 Match Tool: Results	127
8.9.4 Using the Match Tool	128
8.9.5 Using Remote TEACH with the Match Tool	130
8.10 Object Tool	130
8.10.1 Object Tool: Input Parameters	130
8.10.2 Object Tool: Test Parameters	136
8.10.3 Object Tool: Results	136
8.10.4 Using the Object Tool	137
9 Using the Inspection Tools: ID Tools	138
9.1 Barcode Tool	138
9.1.1 ROI	138
9.1.2 Barcode Tool: Input Parameters	138
9.1.3 Barcode Tool: Test Parameters	145
9.1.4 Barcode Tool: Results	146
9.1.5 Using the Barcode Tool	146
10 Using the Inspection Tools: Analysis Tools	149
10.1 Math Tool	149
10.1.1 Math Tool: Input Parameters	149
10.1.2 Math Tool: Test Parameters	151
10.1.3 Math Tool: Results	151

10.1.4 Using the Math Tool	152
10.2 Measure Tool	153
10.2.1 Measure Tool: Operations	153
10.2.2 Measure Tool: Input Parameters	154
10.2.3 Measure Tool: Test Parameters	156
10.2.4 Measure Tool: Results	157
10.2.5 Using the Edge and Measure Tools	157
10.3 Logic Tool	159
10.3.1 Logic Tool: Input Parameters	160
10.3.2 Logic Tool: Test Parameters	161
10.3.3 Logic Tool: Results	161
10.3.4 Using the Logic Tool	162
11 Emulators	164
11.1 Backup or Restore the Emulator	164
12 Sensor Display	165
12.1 Sensor Display Interface	165
12.2 Locking and Unlocking the Sensor	165
12.3 Sensor Menu	166
12.4 Ethernet Menu (ETHER)	167
12.5 Product Change Menu (PCHANGE)	167
12.6 Input/Output Menu (IO)	167
12.7 Image Menu (IMAGE)	167
12.8 Information Menu (INFO)	167
12.9 System Error Menu (SYSERR)	168
12.10 Display Menu (DISPLAY)	168
12.11 Reboot Menu (REBOOT)	168
13 Communications Guide	169
13.1 Communication Summary	169
13.1.1 Communication Channels	169
13.1.2 Industrial Ethernet	169
13.1.3 Data Export	169
13.1.4 Image Export: TCP/IP	171
13.1.5 Image Export: FTP	173
13.1.6 Input String: TCP/IP	175
13.2 Enabling Communications	176
13.2.1 Setting Up Ethernet Communications	176
13.2.2 Windows 7	176
13.2.3 Communications Channel Ports	176
14 Industrial Ethernet Overview	177
14.1 Industrial Ethernet Setup	177
14.1.1 Set the Industrial Ethernet Protocol (EtherNet/IP™, PROFINET®, Modbus/TCP, PCCC)	177
14.1.2 Set the Trigger Mode	177
14.2 Supported Functions	177
14.2.1 Sensor Input Values	178
14.2.2 Sensor Output Values	178
14.3 EtherNet/IP™	178
14.3.1 Inputs to the Sensor (Outputs from the PLC)	181
14.3.2 Outputs from the Sensor (Inputs to the PLC)	182
14.3.3 Input and Output Bits	183
14.3.4 Sensor Pass/Fail Bits	184
14.3.5 Tool-Specific Results: EtherNet/IP	184
14.3.6 Configuration Assembly Object	186
14.3.7 Data Formats	186
14.3.8 Minimum Requested Packet Interval (RPI) Value	186
14.3.9 VE Series Smart Camera EDS File Installation in ControlLogix Software	186
14.3.10 RSLogix5000 Configuration	191
14.4 Modbus/TCP	198
14.4.1 Sensor Input Values	203
14.4.2 VE Series camera Output Values	204
14.4.3 Input and Output Bits	204
14.4.4 Sensor Pass/Fail Bits	205
14.4.5 Tool-Specific Results: Modbus/TCP	205
14.5 PLC5, SLC500, and MicroLogix (PCCC)	207
14.5.1 Configuration	210
14.5.2 Inputs to the Sensor (Outputs from the PLC)	214
14.5.3 Outputs from the Sensor (Inputs to the PLC)	214
14.5.4 Input and Output Bits	215
14.5.5 Sensor Pass/Fail Bits	215
14.5.6 Tool-Specific Results: PCCC	216
14.6 PROFINET®	217

14.6.1 General Station Description (GSD) File	217
14.6.2 PROFINET IO Data Model	217
14.6.3 Configure the VE Series Smart Camera for a PROFINET IO Connection	217
14.6.4 Description of Modules and Submodules	218
14.6.5 Description of Submodules	219
14.6.6 Configuration Instructions	226
14.7 Troubleshooting	236
14.7.1 Industrial Ethernet Error Codes	236
14.7.2 PROFINET	237
15 Webserver Image Viewing	239
15.1 Image Size	239
15.2 Images on Example HMIs	240
15.3 Images on a Web Browser	242
16 Troubleshooting	243
16.1 Vision Manager Error Codes	243
16.2 VE Error and Warning Codes	254
16.3 TCP and UDP Port Numbers	255
17 Accessories	256
17.1 Cordsets	256
17.2 Brackets	256
17.3 Lenses	257
17.3.1 WVGA Lens Working Distance and Field of View	257
17.3.2 1.3 MP Lens Working Distance and Field of View	258
17.3.3 2 MP Lens Working Distance and Field of View	258
17.3.4 5 MP Lens Working Distance and Field of View	259
17.4 C-Mount Lens Filter Models	259
17.5 Sealed Lens Cover	260
17.6 Display Cover	260
17.7 Ring Lights	260
17.8 Interface Module	261
18 Product Support and Maintenance	263
18.1 Repairs	263
18.2 Maintenance	263
18.2.1 Clean the VE	263
18.2.2 Clean the Lens	263
18.2.3 Update the Software and Firmware	263
18.3 Contact Us	263
18.4 Banner Engineering Corp Limited Warranty	263

1 Product Description

Self-contained Smart Camera with User-Friendly Vision Manager Software



- Banner's free and easy-to-use Vision Manager Software provides a number of tools and capabilities that enable VE Series smart cameras to solve a wide range of vision or identification applications, such as item detection, part positioning, feature measurement, flaw analysis, and barcode reading
- Runtime editing capability reduces costly downtime and the software emulator allows for offline building and troubleshooting of applications
- Factory communications (EtherNet/IP™, Modbus/TCP, PROFINET®, FTP and Serial RS-232) for integration on the manufacturing floor
- Six optically isolated I/O and an external light connector on the smart camera
- Two-line, eight-character onboard display provides smart camera information and focus number and makes it easy to update the smart camera settings, facilitating fast product changeover
- Robust metal housing with optional sealed lens covers to achieve IP67 rating for use in harsh environments with heat, vibration, or moisture
- Bright indicator lights for easy viewing of smart camera status



WARNING: Not To Be Used for Personnel Protection

Never use this device as a sensing device for personnel protection. Doing so could lead to serious injury or death. This device does not include the self-checking redundant circuitry necessary to allow its use in personnel safety applications. A sensor failure or malfunction can cause either an energized or de-energized sensor output condition.



CAUTION: Electrostatic Discharge

Avoid the damage that electrostatic discharge (ESD) can cause to the Sensor.

Always use a proven method for preventing electrostatic discharge when installing a lens or attaching a cable.



CAUTION: Hot Surface

Use caution when handling the camera. The surface of the camera may be hot during operation and immediately after use.

1.1 Models

Model ²	Resolution	Type
VE200G1A	WVGA, 752 × 480 pixels grayscale	Vision
VE201G1A	1.3 MP, 1280 × 1024 pixels grayscale	Vision
VE202G1A	2 MP, 1600 × 1200 pixels grayscale	Vision
VE205G1A	5 MP, 2592 × 2048 pixels grayscale	Vision
VE200G1B	WVGA, 752 × 480 pixels grayscale	ID
VE201G1B	1.3 MP, 1280 × 1024 pixels grayscale	ID
VE202G1B	2 MP, 1600 × 1200 pixels grayscale	ID
VE205G1B	5 MP, 2592 × 2048 pixels grayscale	ID
VE200G1C	WVGA, 752 × 480 pixels grayscale	Vision + ID
VE201G1C	1.3 MP, 1280 × 1024 pixels grayscale	Vision + ID
VE202G1C	2 MP, 1600 × 1200 pixels grayscale	Vision + ID

² Model VE202G2A, 2 MP, 1600 × 1200 grayscale with 4-pin D-code M12 Ethernet connection is also available.

Model ²	Resolution	Type
VE205G1C	5 MP, 2592 × 2048 pixels grayscale	Vision + ID

² Model VE202G2A, 2 MP, 1600 × 1200 grayscale with 4-pin D-code M12 Ethernet connection is also available.

2 Overview

The VE Series Smart Camera is easy to use and has advanced visual inspection or identification capabilities for automation or control applications. Users can quickly set up the sensor using the Vision Manager software to solve a diverse range of applications on the factory floor.

2.1 Features

Figure 1. Sensor Features



1. Display
2. Buttons
3. Pass/Fail indicator (green/red)
4. Ready/Trigger indicator (green/amber)
5. Power/Error indicator (green/red)
6. Ethernet indicator (amber), not shown
7. Ethernet connection
8. Light connection
9. Power, Discrete I/O connection

2.1.1 Display

Figure 2. Display with Home Screen



The display is a 2-line, 8-character LCD. The main screen is the Home Screen, which shows the name of the current inspection and the slot number (inspection location). Use the display to view or change several sensor settings.

2.1.2 Indicators

Four LED indicators provide ongoing indication of the sensing status.



! Power/Error Indicator

Green = Normal operation
Red = System error



● Ready/Trigger Indicator

Green = Ready for trigger
Yellow = Trigger is active
OFF = Not ready for a trigger, triggers will be missed



✘ Pass/Fail Indicator



Green = Previous inspection passed
Red = Previous inspection failed
OFF = No trigger since power up



● Ethernet Indicator

Amber solid = Ethernet connection
Amber flashing = Ethernet activity
OFF = no connection

2.1.3 Buttons

Use the sensor buttons **Down** , **Up** , **Enter** , and **Escape**  to configure several sensor settings and to access sensor information. See [Figure 318](#) on p. 166 for additional information on using the buttons.

2.2 Vision Manager Software

Set up the VE Series Smart Camera using the free Vision Manager Software, available for download at www.bannerengineering.com.

This easy-to-use image processing software provides a variety of tools and capabilities to solve a wide range of vision applications such as item detection, part positioning, feature measurement, flaw analysis, and barcode reading. Run-time editing allows you to make changes to an inspection while the sensor is running, reducing costly downtime. Vision Manager also includes a full software emulator, allowing users to develop or troubleshoot inspections offline, without a sensor.

Password-protected user profiles are also available to enable different levels of access to the tools and data.

Use Vision Manager to configure Banner vision devices including iVu Vision Sensors and VE Smart Cameras.

3 Specifications and Requirements

3.1 Specifications

Power

12 V dc to 30 V dc (24 V dc \pm 10% if a Banner light source is powered by the sensor)

Current: 400 mA maximum (exclusive of load and lights)

Use only with a suitable Class 2 power supply, or current limiting power supply rated 12 V DC to 30 V DC, 1 A

Supply Protection Circuitry

Protected against reverse polarity and transient overvoltages

Discrete I/O

1 Trigger IN

5 Programmable I/O

Output Configuration

Optically isolated

Output Rating

Output Resistance: < 2 Ω

Strobe Output Resistance: < 13 Ω

Programmable Output: 100 mA

External Strobe Output: 100 mA

Off-State Leakage Current: < 100 μ A

External Light Maximum Current Draw

350 mA

Exposure Time

0.01 ms to 500 ms

Imager

VE200G1x: 6.9 mm \times 5.5 mm, 8.7 mm diagonal (1/1.8-inch CMOS)

VE201G1x: 6.9 mm \times 5.5 mm, 8.7 mm diagonal (1/1.8-inch CMOS)

VE202Gxx: 7.2 mm \times 5.4 mm, 9.0 mm diagonal (1/1.8-inch CMOS)

VE205G1x: 12.4 mm \times 9.8 mm, 15.9 mm diagonal (1-inch CMOS)

Lens

C-mount

Pixel Size

VE200G1x: 5.3 μ m

VE201G1x: 5.3 μ m

VE202Gxx: 4.5 μ m

VE205G1x: 4.8 μ m

Communication

10/100/1000 ⁴ Mbps Ethernet

Communication Protocols

Ethernet/IP™, Modbus/TCP, PCCC, PROFINET®, TCP/IP, FTP, and RS-232

Memory

Device Settings and Inspection Storage Memory: 500 MB

Number of inspection files: 999

Acquisition

256 grayscale levels

Model	Frames Per Second ³	Image Size
VE200G1x	60 fps, maximum	752 \times 480 px
VE201G1x	60 fps, maximum	1280 \times 1024 px
VE202Gxx	50 fps, maximum	1600 \times 1200 px
VE205G1x	22 fps, maximum	2592 \times 2048 px

Torque—Tapped Holes for Mounting Screws

8 lbf-in (0.9 N·m) maximum torque

Construction

Housing: Aluminum

Display Label: Polyester

Connections

Ethernet: M12, 8-pin A-code or 4-pin D-code Euro-style female

Light Connector: M8, 3-pin Pico-style female

Power, Discrete I/O: M12, 12-pin Euro-style male

Environmental Rating

IEC IP67 with an optional sealed lens cover properly installed

Operating Conditions

Operating Temperature: 0 °C to +50 °C (+32 °F to +122 °F)

95% maximum relative humidity (non-condensing)

Stable Ambient Lighting: No large, quick changes in light level; no direct or reflected sunlight

Storage Temperature: -30 °C to +70 °C (-22 °F to +158 °F)

Vibration and Mechanical Shock

Meets EN 60947-5-2; IEC 60068-2-27 (Shock: 30G); IEC 60068-2-6 (Vibration: 10 Hz to 60 Hz, 1 mm amplitude)

Certifications



Information
Technology
Equipment
E365235



EtherNet/IP®

3.2 PC Requirements

Operating System

Microsoft® Windows® operating system version 7, 8, or 10 ⁵

System Type

32-bit, 64-bit

Hard Drive Space

80 MB (plus up to 280 MB for Microsoft .NET 4.5, if not already installed)

Memory (RAM)

512 MB minimum, 1 GB+ recommended

Processor

1 GHz minimum, 2 GHz+ recommended

Screen Resolution

1024 \times 768 full color minimum, 1650 \times 1050 full color recommended

Third-Party Software

Microsoft .NET 4.5, PDF Viewer (such as Adobe Acrobat)

USB Port

USB 3.0, recommended if a USB to Ethernet adapter used to communicate with the sensor

³ This value can vary based on inspection settings.

⁴ 1000 Mbps communication speed not available on 4-pin Ethernet models

⁵ Microsoft and Windows are registered trademarks of Microsoft Corporation in the United States and/or other countries.



Important: Administrative rights are required to install the Vision Manager software.

3.3 Dimensions

All measurements are listed in millimeters [inches], unless noted otherwise.

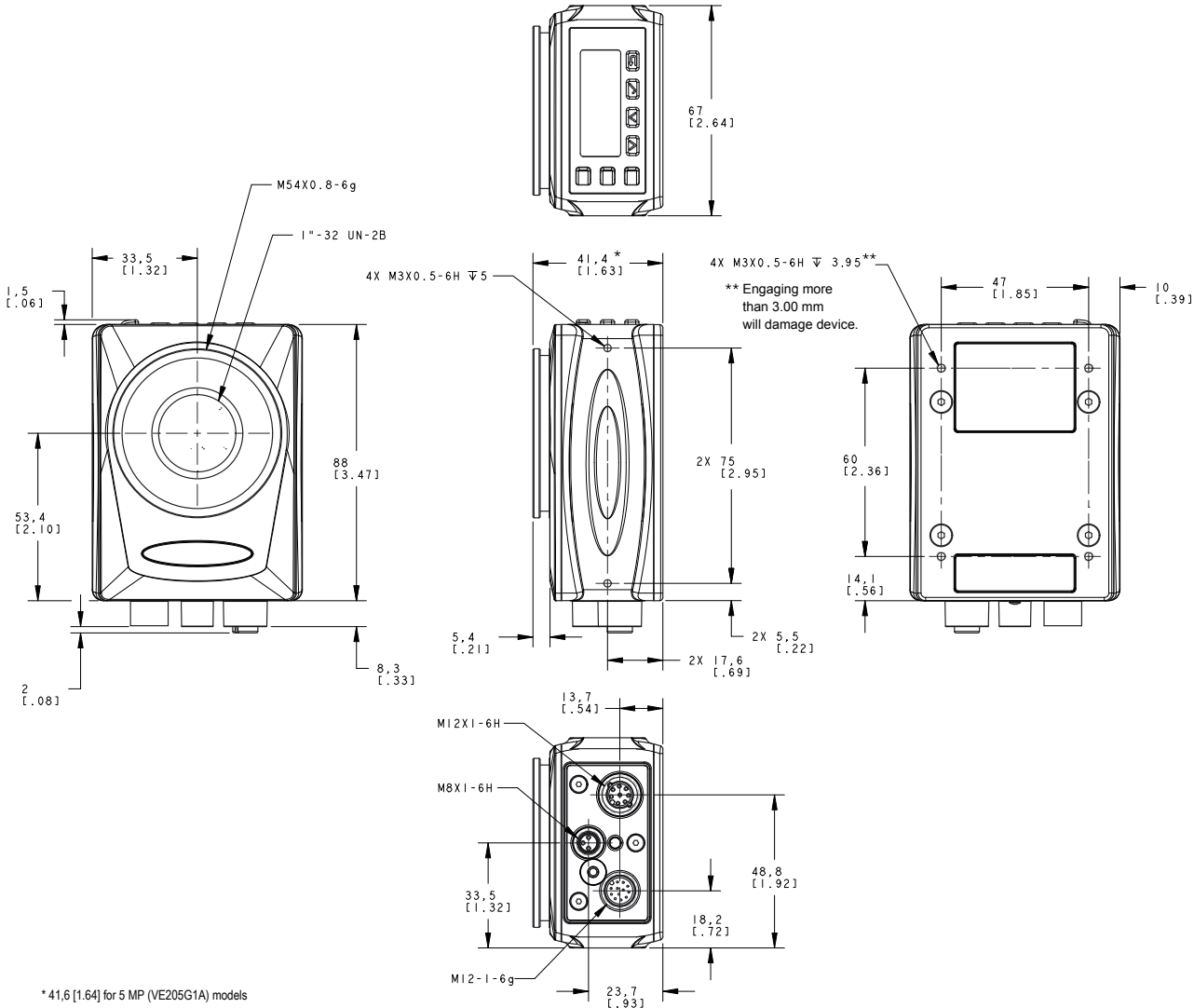

3.4 Banner Engineering Corp. Software Copyright Notice

This software is protected by copyright, trade secret, and other intellectual property laws. You are only granted the right to use the software and only for the purposes described by Banner. Banner reserves all other rights in this software. For so long as you have obtained an authorized copy of this software directly from Banner, Banner grants you a limited, nonexclusive, nontransferable right and license to use this software.

You agree not to use, nor permit any third party to use, this software or content in a manner that violates any applicable law, regulation or terms of use under this Agreement. You agree that you will not reproduce, modify, copy, deconstruct, sell, trade or resell this software or make it available to any file-sharing or application hosting service.

Disclaimer of Warranties. Your use of this software is entirely at your own risk, except as described in this agreement. This software is provided "AS-IS." To the maximum extent permitted by applicable law, Banner, its affiliates, and its channel partners disclaim all warranties, expressed or implied, including any warranty that the software is fit for a particular purpose, title, merchantability, data loss, non-interference with or non-infringement of any intellectual property rights, or the accuracy, reliability, quality or content in or linked to the services. Banner and its affiliates and channel partners do not warrant that the services are secure, free from bugs, viruses, interruption, errors, theft or destruction. If the exclusions for implied warranties do not apply to you, any implied warranties are limited to 60 days from the date of first use of this software.

Limitation of Liability and Indemnity. Banner, its affiliates and channel partners are not liable for indirect, special, incidental, punitive or consequential damages, damages relating to corruption, security, loss or theft of data, viruses, spyware, loss of business, revenue, profits, or investment, or use of software or hardware that does not meet Banner minimum systems requirements. The above limitations apply even if Banner and its affiliates and channel partners have been advised of the possibility of such damages. This Agreement sets forth the entire liability of Banner, its affiliates and your exclusive remedy with respect to the software use. You agree to indemnify and hold Banner and its affiliates and channel partners harmless from any and all claims, liability and expenses, including reasonable attorney's fees and costs, arising out of your use of the Services or breach of this Agreement (collectively referred to as "Claims"). Banner reserves the right at its sole discretion and at its own expense, to assume the exclusive defense and control of any Claims. You agree to reasonably cooperate as requested by Banner in defense of any Claims.

3.5 Additional Copyright Information

The Vision Manager software includes code that is copyright (c) 1985, 1989 Regents of the University of California. All rights reserved.

Redistribution and use in source and binary forms, with or without modification, are permitted provided that the following conditions are met:

1. Redistributions of source code must retain the above copyright notice, this list of conditions and the following disclaimer.
2. Redistributions in binary form must reproduce the above copyright notice, this list of conditions and the following disclaimer in the documentation and/or other materials provided with the distribution.
3. All advertising materials mentioning features or use of this software must display the following acknowledgement: This product includes software developed by the University of California, Berkeley and its contributors.
4. Neither the name of the University nor the names of its contributors may be used to endorse or promote products derived from this software without specific prior written permission.

THIS SOFTWARE IS PROVIDED BY THE REGENTS AND CONTRIBUTORS "AS IS" AND ANY EXPRESS OR IMPLIED WARRANTIES, INCLUDING, BUT NOT LIMITED TO, THE IMPLIED WARRANTIES OF MERCHANTABILITY AND FITNESS FOR A PARTICULAR PURPOSE ARE DISCLAIMED. IN NO EVENT SHALL THE REGENTS OR CONTRIBUTORS BE LIABLE FOR ANY DIRECT, INDIRECT, INCIDENTAL, SPECIAL, EXEMPLARY, OR CONSEQUENTIAL DAMAGES (INCLUDING, BUT NOT LIMITED TO, PROCUREMENT OF SUBSTITUTE GOODS OR SERVICES; LOSS OF USE, DATA, OR PROFITS; OR BUSINESS INTERRUPTION) HOWEVER CAUSED AND ON ANY THEORY OF LIABILITY, WHETHER IN CONTRACT, STRICT LIABILITY, OR TORT (INCLUDING NEGLIGENCE OR OTHERWISE) ARISING IN ANY WAY OUT OF THE USE OF THIS SOFTWARE, EVEN IF ADVISED OF THE POSSIBILITY OF SUCH DAMAGE.

3.6 Trademarks

ControlLogix® is a trademark of Rockwell Automation, Inc.

EtherNet/IP™ is a trademark of ODVA, Inc.

Microsoft and Windows are registered trademarks of Microsoft Corporation in the United States and/or other countries.

PROFINET® is a registered trademark of PROFIBUS Nutzerorganisation e.V.

All other trademarks and registered trademarks cited are the property of their respective owners.

4 Installation Instructions

4.1 Install the Accessories

Figure 3. Install the Accessories



1. VE sensor
2. O-ring (used with the sealed lens cover)
3. C-mount lens (available separately)
4. Filter (optional)
5. Sealed lens cover (optional)

An external light (optional) is not shown.



Note: A sealed lens cover and a ring light cannot be used together.

1. If you are using a sealed lens cover: Remove the black thread protector (not shown) from the sensor (1).
2. If you are using a sealed lens cover: Fit a single o-ring (2) into the undercut area behind the sensor threads.
3. Remove the yellow temporary imager cover (not shown) from the sensor.



CAUTION: Do not remove the imager cover until you are ready to install the lens. Do not touch the imager. Dirt or dust on the imager can affect sensing reliability.

4. Remove any protective covers from the lens. Handle the lens carefully to avoid smudges and dirt on the optical elements.
5. Thread the lens (3) onto the sensor.
6. Make sure that the lens is focused; see [Acquire a Good Image](#) on p. 18.
7. Use the thumbscrews on the lens to lock the focus and aperture rings and to prevent movement that can occur during cleaning or accidental contact.
8. If you are using a filter: Thread the filter (4) onto the front of the C-mount lens.
9. If you are using a linear polarization filter: Rotate the outer portion of the filter mount to determine the position where glare is reduced the most, and use the locking thumbscrew to fasten the filter in position.
10. If you are using a sealed lens cover: Thread the sealed lens cover (5) onto the threaded portion of the sensor.
11. Or, if you are using an external light bracket: Attach an external light bracket to the sensor using the provided hardware kit.



Note: For optimal imaging, provide adequate dissipation of heat. A good heat conductor, such as aluminum, may be required.

4.2 Mount the Sensor

1. If a bracket is needed, mount the device onto the bracket.
2. Mount the device (or the device and the bracket) to the machine or equipment at the desired location. Do not tighten the mounting screws at this time.



CAUTION: This device accepts M3×0.5-h6 screws. Engaging the screws more than 3.00 mm will damage the device.

3. Check the device alignment.
4. Tighten the mounting screws to secure the device (or the device and the bracket) in the aligned position.

4.3 Connect the Cables

Figure 4. Cable Connections

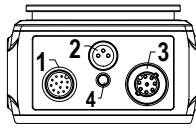

1. Power, Discrete I/O connection
2. Light connection
3. Ethernet connection
4. Ethernet indicator



1. Connect the Ethernet cable to the sensor (3) and to the computer or Ethernet switch.
2. Connect the power, discrete I/O cable to the sensor (1), and the leads to the appropriate locations. See [Table 1](#) on p. 14 for the power, discrete I/O connections.
3. Connect the external light cable (optional) to the light connection (2) if the light is powered by the sensor.



CAUTION: Use Appropriate Power

If the light is powered by the sensor, the sensor power source must be 24 V dc. This connection is for Banner lights only.

Table 1: Power and I/O Pinouts

Pin	Wire Color	Description	Direction
1	White	Discrete I/O #3	Input/Output
2	Brown	12 V dc to 30 V dc	Input
3	Green	I/O output common  Important: For PNP (sourcing) outputs connect pin 3 to +V dc, for NPN (sinking) outputs connect pin 3 to 0 V dc. The discrete I/O pins are 1, 5, 8, 10, and 11.	-
4	Yellow	RS-232 TX (transmit)	Output
5	Gray	Discrete I/O #5	Input/Output
6	Pink	Trigger input	Input
7	Blue	Common	Input
8	Red	Discrete I/O #2	Input/Output
9	Orange	I/O input common  Important: For PNP (sourcing) inputs connect pin 9 to 0 V dc, for NPN (sinking) inputs connect pin 9 to +V dc. The discrete I/O pins are 1, 5, 6, 8, 10, and 11.	-
10	Light Blue	Discrete I/O #4	Input/Output
11	Black	Discrete I/O #1	Input/Output
12	Violet	RS-232 RX (receive)	Input
Shield	Bare metal	Chassis ground	-

4.3.1 Wiring Diagrams

Figure 5. PNP Output

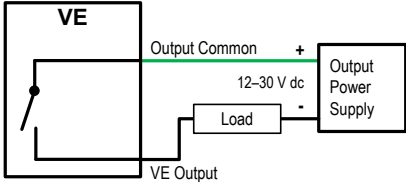

Figure 6. NPN Output

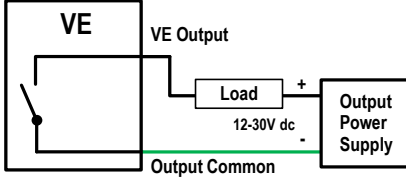

Figure 7. PNP Input

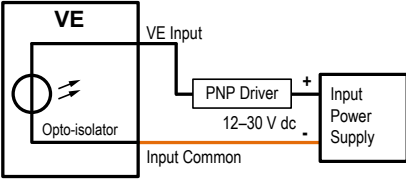

Figure 8. NPN Input

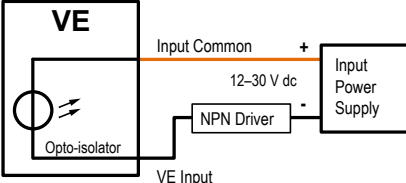
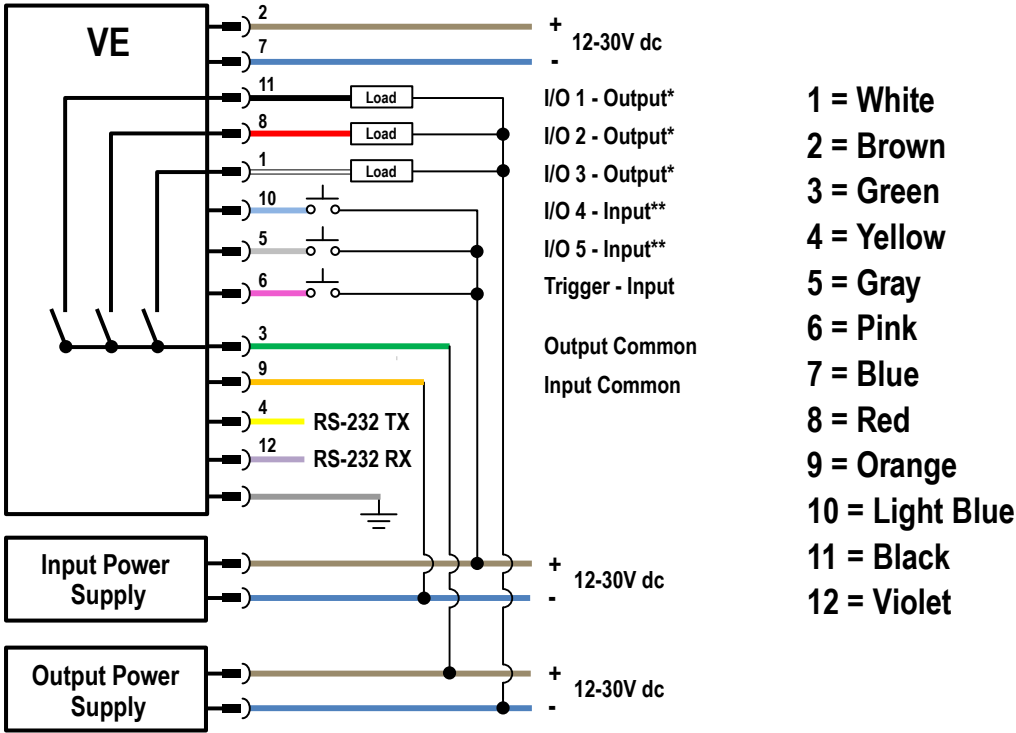

Figure 9. PNP Inputs and Outputs

PNP Inputs & Outputs



This is a typical example. Applications may vary.
 *Programmable I/O shown set as an output in this example
 **Programmable I/O shown set as an input in this example

Figure 10. NPN Inputs and Outputs

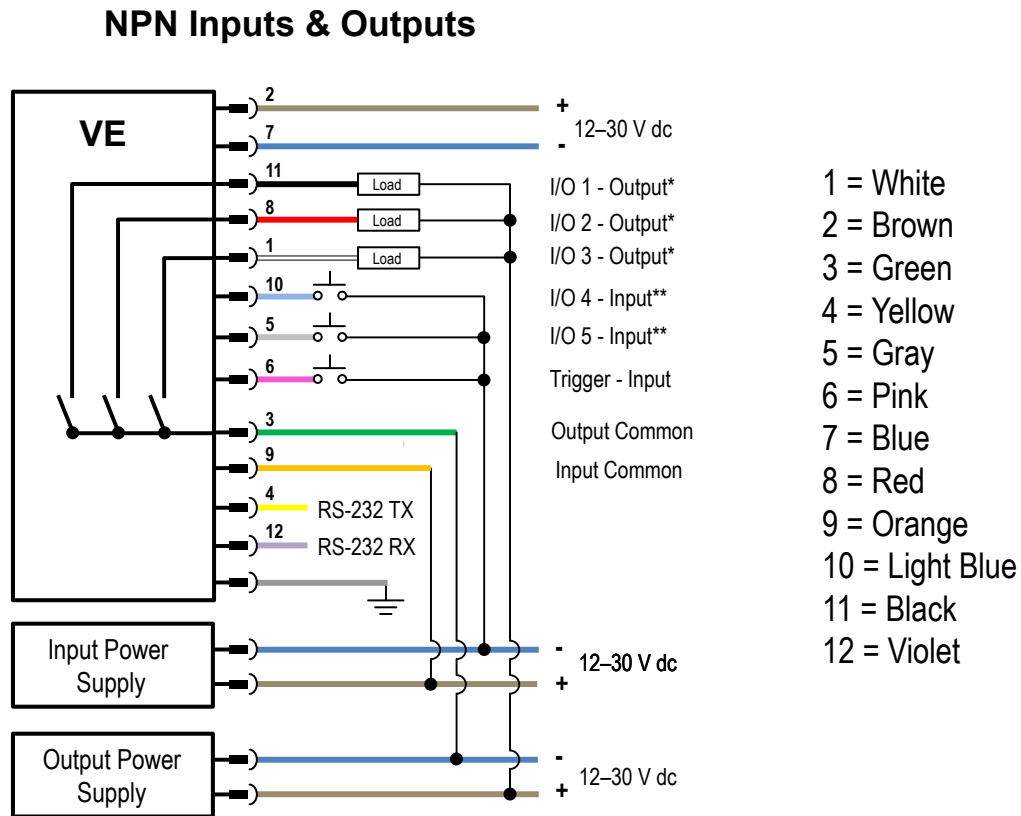

This is a typical example. Applications may vary.
 * Programmable I/O shown set as an output in this example.
 ** Programmable I/O shown set as an input in this example.

4.4 Install the Software



Important: Administrative rights are required to install the Vision Manager software.

1. Download the latest version of the software from www.bannerengineering.com.
2. Navigate to and open the downloaded file.
3. Click **Next** to begin the installation process.
4. Confirm the software destination and availability for users and click **Next**.
5. Click **Install** to install the software.
6. Depending on your system settings, a popup window may appear prompting to allow Vision Manager to make changes to your computer. Click **Yes**.
7. Click **Close** to exit the installer.

5 Getting Started

Power up the sensor, and verify that the  power/error LED is ON green and that the Ethernet indicator is ON amber to verify the Ethernet connection.





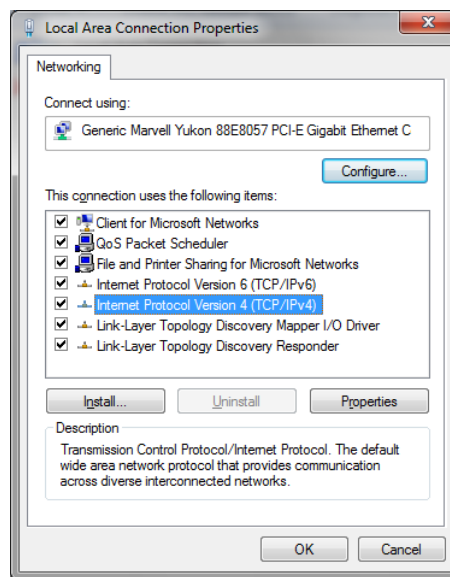

5.1 Connect to the Sensor

These instructions use Windows® operating system version 7, 8, or 10. ⁶

1. Confirm the network connections.
 - a) Click the **Start** button, then on the **Start** menu, click **Control Panel**.
 - b) In **Control Panel**, click **Network and Internet**, then click **Network and Sharing Center**, and then click **Change adapter settings**.
 - c) Right-click on the connection that you want to change, then click **Properties**.
If you are prompted for an administrator password or confirmation, enter the password or provide confirmation.
 - d) In the connection properties, click **Internet Protocol Version 4 (TCP/IPv4)**, and then click **Properties**.

Figure 11. Local Area Connection Properties



- e) In the **Internet Protocol (TCP/IPv4) Properties**, select **Use the following IP address**.
- f) Make sure that the IP address is 192.168.0.2, and the subnet mask is 255.255.255.0.
2. Open Vision Manager from the desktop or the **Start** menu.
The **Sensor Neighborhood** tab displays and lists the available sensors.
3. From **Sensor Neighborhood**, click  to connect to the desired sensor.
The status changes from **Available**  to **Connected**  and the  **Sensor** screen displays. Click  to disconnect from the sensor.
4. If the desired sensor is not listed, verify that:
 - The network adapter connected to the sensor has the same subnet mask as the sensor (for example, 192.168.0.xxx); view the subnet mask in the Network Adapters list at  **Home** > **Sensor Neighborhood** > **Network Adapters**
 - The Ethernet cable is the correct type
 - The TCP/IPv4 settings are correct
 Or, manually enter the sensor's IP address.





Note: The sensor's IP address and subnet mask are also available from the sensor display.

⁶ Windows is a registered trademark of Microsoft Corporation in the United States and/or other countries.

5.2 Acquire a Good Image

The sensor needs to capture a good image of each part to ensure that it correctly passes good parts and fails bad parts.

1. Make sure that the lighting is appropriate for your target. Use supplementary lighting, such as a ring light, if necessary.
2. Click the  **Sensor** screen.
3. Click the  camera tool on **Tools and Results**.
The **Inputs** parameters display.
4. Set the trigger.
 - a) Expand the **Trigger** parameters.
 - b) In the **Trigger Mode** list, click **Internal** (continuous images).
5. Run Auto Exposure.
 - a) Expand the **Imager** parameters.
 - b) Expand the **Auto Exposure** parameters, and click **Start** to run.
6. Check the lighting on the part.
 - Make sure that the lighting is constant and consistent (unchanging over time, no shadows or hot spots)
 - Capture the shape and form of the target object with lighting that optimizes its contrast and separates the feature of interest from the background. Depending on the target, consider other Banner lights
 - Adjust the mounting angle to provide the clearest image of the part features you are inspecting
7. After checking and adjusting the lighting, run **Auto Exposure** a second time or adjust the exposure manually by expanding the **Exposure** parameters and moving the slider or entering a specific exposure time.
8. Adjust the focus.
 - a) Place the part so that the area to be focused appears in the center of the **Image** pane.
 - b) Expand the **Focus Info** parameters.
 - c) Make sure that the **Focus Info** checkbox is selected.
 - d) Adjust the focus of the lens while monitoring the focus number.

The focus number is a number between 1 and 255. Use the **Image** pane to determine when the image is sharp enough, or use the focus number as a guide. Turn the focus ring on the lens until the focus number is at the highest possible number between 1 and 255. The focus number is also available on the sensor display.





Note: There is no optimal value for this number, but it can be used as a guide if you are setting up more than one sensor that are focused on the same target.

- e) Tighten the locking thumbscrews to secure the lens at the desired focus.

5.3 Set Up an Inspection

Vision Manager allows you to set up or make changes to an inspection while the sensor is running. Changes are automatically saved as they are made.

1. From the  **Sensor** screen, click  in the upper right corner to view the inspection list.
2. Click **Add New Inspection**.
A new inspection is added to the list, the **Image** pane updates, and the **Tools & Results** tab shows only the camera tool.



Note: The camera tool for the new inspection inherits the parameters of the camera tool for the previous inspection, however the two are not linked together.















3. Add tools and adjust them as needed for the inspection.

5.3.1 Add a Tool



1. Click  on the **Tools & Results** tab.
The **Add Tool** window opens.
2. Click the desired tool.



Note: Not all tools are available for all VE models, with the exception of Vision + ID models.

Tool Name	Description	Available on:	
		Vision Models	ID Models
 Average Gray	Evaluates pixel brightness within an ROI and computes the average grayscale value. See Average Gray Tool on p. 61.	x	
 Bead	Inspects parts for uniformity of adhesive or sealant material, or for uniformity of a gap. See Bead Tool on p. 65.	x	
 Barcode	Finds and reads 1D and 2D barcodes. See Barcode Tool on p. 138.		x
 Blemish	Determines whether flaws are present on a part, or detects whether a feature exists on a part. See Blemish Tool on p. 75.	x	
 Blob	Detects and counts/locates groups of connected light or dark pixels within the ROI and designates them as blobs (Binary Large Objects). After blobs are found, they can be characterized by size and shape. See Blob Tool on p. 80.	x	
 Circle Detect	Detects a single circle or piece of a circle (arc). See Circle Detect Tool on p. 91.	x	
 Edge	Detects and counts transitions between bright and dark pixels (edges). Counts the total number of edges, and determines the position of each edge. See Edge Tool on p. 98.	x	
 Line Detect	Locates a single, straight line segment by finding edge points along bright or dark pixel transitions and fitting a line to those points. See Line Detect Tool on p. 106	x	
 Locate	Finds the first edge on a part and compensates for translation and rotation of downstream tools (if selected). See Locate Tool on p. 112.	x	x
 Match	Verifies that a pattern, shape, or part in any orientation matches a reference pattern. Can also compensate for translation and rotation of downstream tools (if selected). See Match Tool on p. 122.	x	
 Object	Detects the edges of dark and bright segments and locates their midpoints. Counts dark and bright segments, and measures the width of each dark and bright segment. See Object Tool on p. 130.	x	
 Math	Performs mathematical operations using tool data or user-supplied constants. Includes basic arithmetic, inequality expressions, and statistical information. See Math Tool on p. 149.	x	x
 Measure	Measures distance, calculates angles, and creates points and lines for use as inputs to other tools. See Measure Tool on p. 153.	x	
 Logic	Uses Boolean logic to combine or convert tool results, or to drive discrete outputs from tool results. Logic tool data can be used to evaluate the results of a single tool or multiple tools. See Logic Tool on p. 159.	x	x

The tool is added to **Tools & Results** and the region of interest (ROI) appears on the **Image** pane.

3. Configure the tool as needed for your application.
 - a) Resize  and rotate  the ROI around the feature to be analyzed.
 - b) Define or view parameters for the tool on the **Input** tab, such as ROI shape, threshold, or view the histogram.
 - c) Define pass or fail criteria on the **Test** tab, such as the count, size, or match.

5.3.2 Rename a Tool

The default tool name is *tool01*, *tool02*, and so on, where the word *tool* is replaced by the appropriate name (for example, *Locate01*, *Edge02*, etc.).

1. On **Tools & Results** or on **Tools Only**, click the tool to select it.
2. Highlight the tool name.
3. Enter the desired tool name.



Note: Use only letters, numbers, spaces, and the underscore in the tool name.

5.3.3 Name an Inspection

The default inspection name is *Inspection01*, *Inspection02*, and so on. Rename the inspection to something meaningful to the application.

1. Click **Inspection Management**, then click **Manage**.

Figure 12. Manage

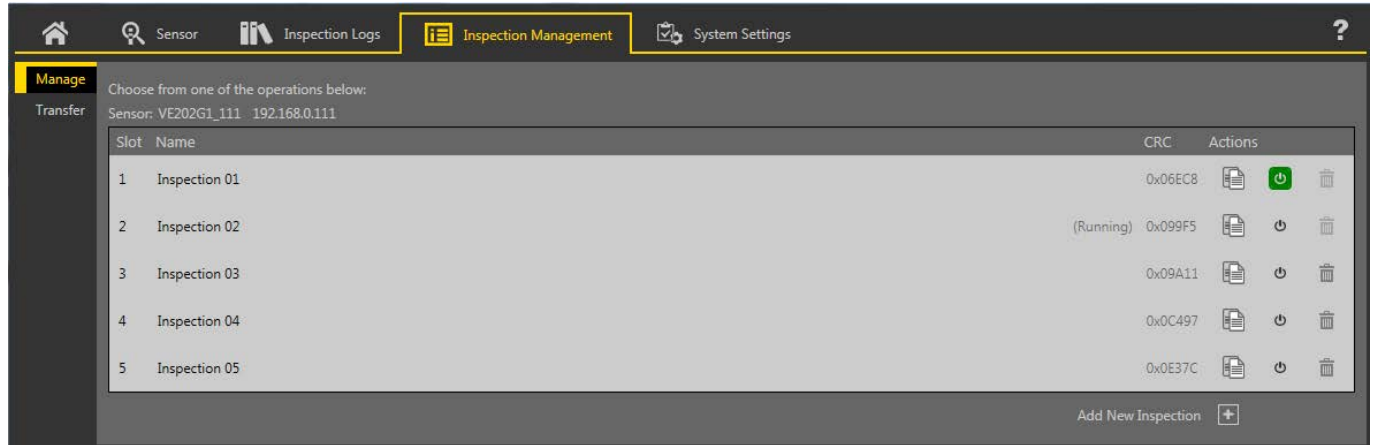

2. Double-click the name of the desired inspection.
3. Enter the new inspection name.



Note: Use only letters, numbers, spaces, and the underscore in the inspection name.

4. Press **Enter** or click off of the name to save the new name.

5.3.4 Save an Inspection to a Computer, Network Drive, or Storage Device

Vision Manager automatically saves inspections to the VE as they are created and modified. Save a copy of the inspection to your computer or another network location if you want to be able to go back to previous settings.

Use the following procedure to save a copy of an inspection to your computer or a network location.

1. On the **Inspection Management** screen, click **Transfer**.

Figure 13. Transfer

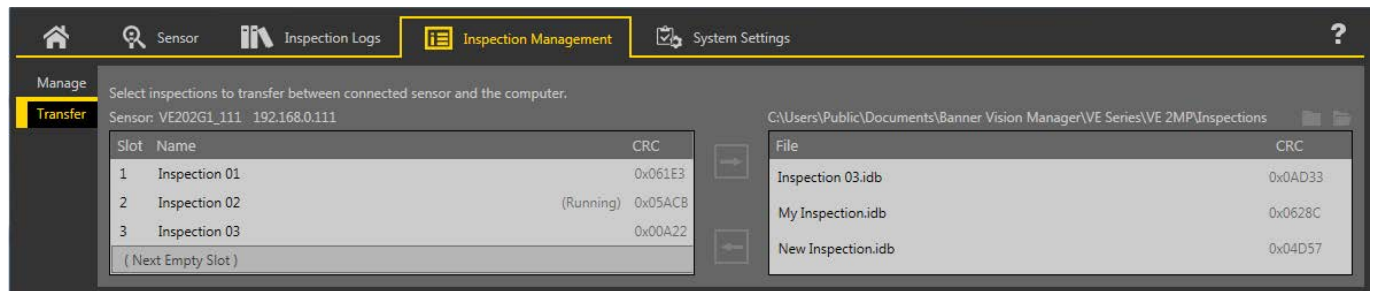

2. Change the destination folder, if desired.
 - a) Click above the right column. An explorer window opens.
 - b) Navigate to the desired location, network location, or storage device.
 - c) Click **Select Folder**. The folder is selected and the window closes. The path to the location displays above the right column.
3. Select the desired inspection from the inspection list in the left column.

4. Click .
Inspection name.idb displays in the right column and the inspection is transferred (saved) to the selected location.

5.3.5 Modify a Currently Running Inspection

1. On the  **Sensor** screen, select the desired inspection from the **Inspection** list.
The inspection tools and parameters display.
2. Make the desired modifications to the inspection.



Important: Changes are automatically saved as they are made. Save a copy of the inspection if you want to be able to go back to previous settings. Use the Emulator to set up or make changes to an inspection offline.

5.3.6 Copy a Tool

Duplicate (copy) a tool to include more than one of the same tool in an inspection.

1. Click the desired tool to duplicate.
2. Click .
A duplicate of the tool is created with the same input and test parameters.
3. Set the tool parameters as desired. The two tools are not linked; changes are independent of each other.

5.3.7 Delete a Tool

Use the following procedure to delete a tool from an inspection.

1. Click the tool on **Tools & Results** or **Tools Only** to select it.
2. Click .
The tool is deleted.



Note: There is no undo option. A deleted tool cannot be recovered.

5.3.8 Delete a Tool and All Tools After It

Use the following procedure to delete a selected tool and all of the tools after it.

1. Click the tool on **Tools & Results** or on **Tools Only** to select it.
2. Click .
The message "Remove selected tool and all tools after it?" displays.
3. Click **Continue**.
The tools are deleted.



Note: There is no undo option. Deleted tools cannot be recovered.

5.3.9 Delete an Inspection

1. Click  **Inspection Management**, then click **Manage**.
2. Select the inspection to be deleted.



Note: This inspection cannot be running and it cannot be selected to begin at startup.

3. Click .
The inspection name turns red and "Inspection marked for deletion" displays.

Figure 14. Inspection Marked for Deletion



4. Click to another tab to delete the inspection, or click **Undo** to keep the inspection.

5.4 Configure the Discrete I/O

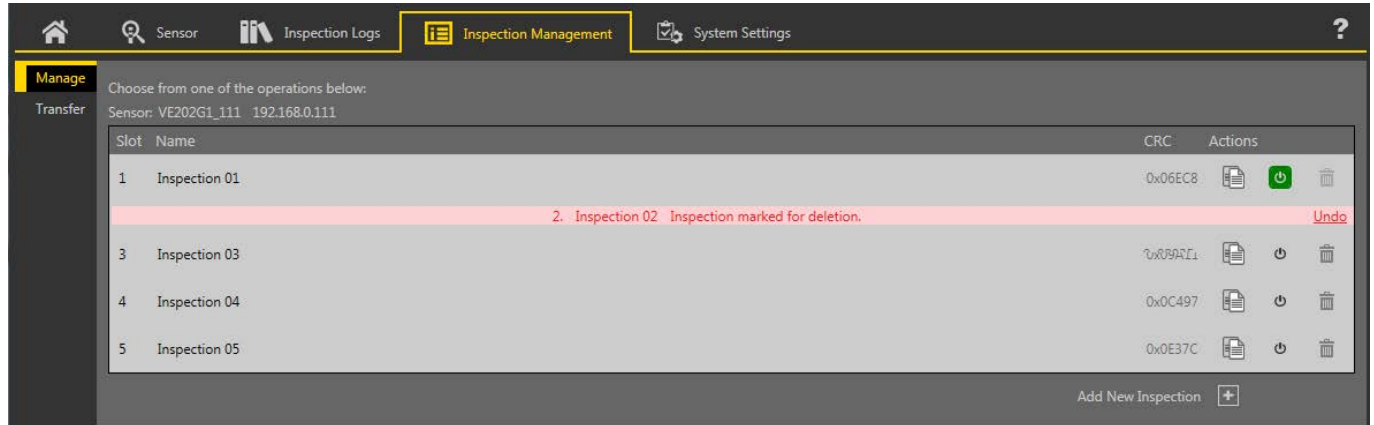
From the **System Settings** screen, select **Discrete I/O** to change the discrete I/O settings.



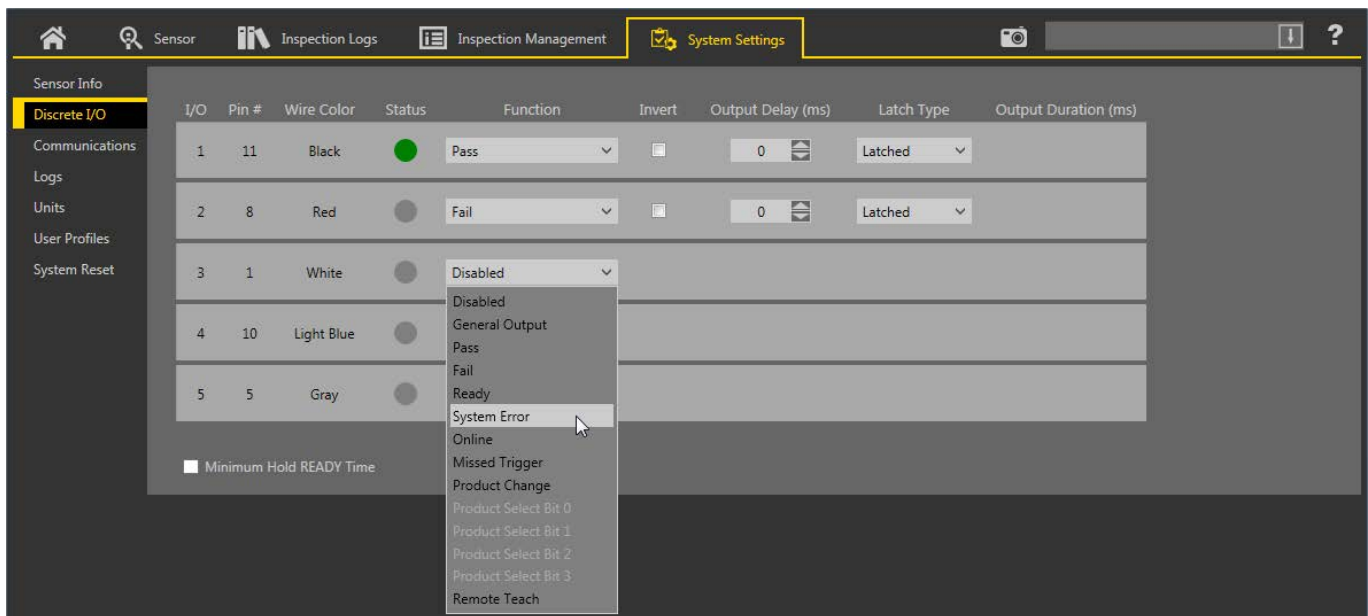

Figure 15. Discrete I/O



For more details, see [Discrete I/O](#) on p. 38.

6 Vision Manager Workspace

Vision Manager has five main working areas, or screens:

- [Home Screen](#) on p. 23—The  **Home** screen provides access to connect to a sensor or emulator, update firmware, and view sensor and Vision Manager software information.
- [Sensor Screen](#) on p. 28—The  **Sensor** screen displays the information needed to create or modify an inspection.
- [Inspection Logs Screen](#) on p. 33—The  **Inspection Logs** screen displays saved images and inspection information. Inspections logs can be viewed when the camera is offline.
- [Inspection Management Screen](#) on p. 34—The  **Inspection Management** screen includes options to add inspections to the currently connected sensor, to rename an inspection, and to transfer inspections between a connected sensor and a network location or storage device.
- [System Settings Screen](#) on p. 37—The  **System Settings** screen provides access to view and adjust sensor information, discrete I/O, communications settings, system logs, and units.

6.1 Home Screen

The  **Home** screen provides access to connect to a sensor or emulator, update firmware, and view sensor and Vision Manager software information.

The following are available from the **Home** screen:

- Sensor Neighborhood
- Sensor Maintenance
- Emulators
- User Preferences
- About

Figure 16. Home Screen

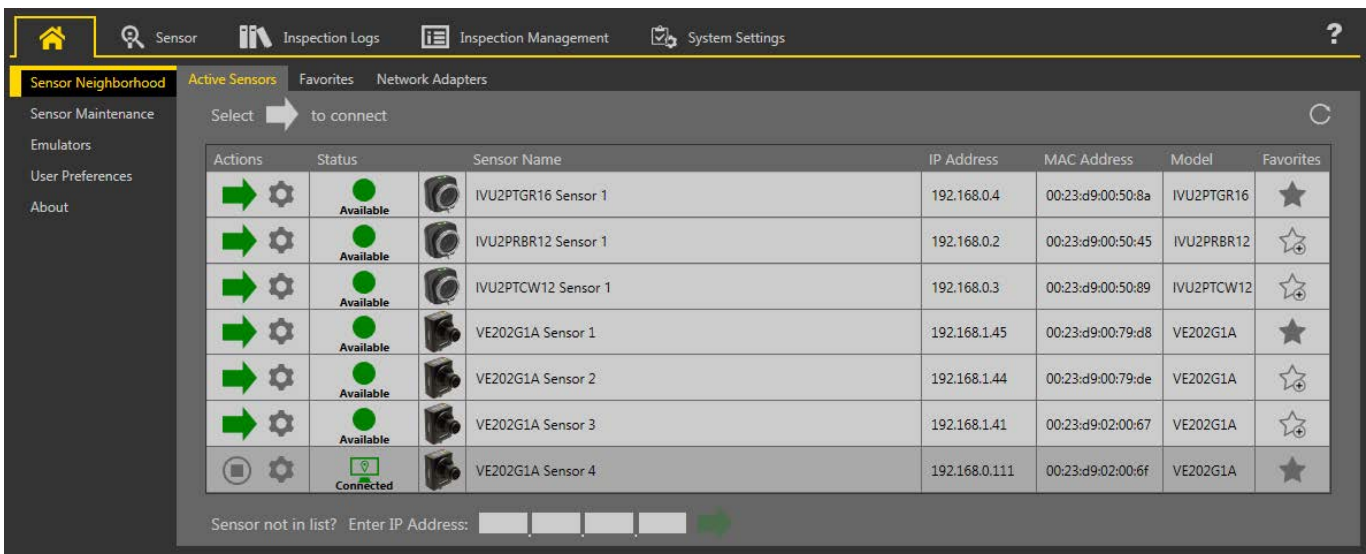

Only one sensor can be connected to each instance of the software. Open more than one instance of Vision Manager if you want to connect to more than one sensor at a time. Only one instance of the software can be connected to the Emulator at a time.

6.1.1 Sensor Neighborhood

Use **Sensor Neighborhood** on the  **Home** screen to connect to active sensors. **Sensor Neighborhood** opens by default when the software is launched.

Active Sensors Tab



Use the **Active Sensors** tab in **Sensor Neighborhood** to connect to an active sensor. Available options vary depending on the type of sensor to which Vision Manager is connected.

Navigate:  **Home** > **Sensor Neighborhood** > **Active Sensors**.

This tab includes sensor information such as sensor status, sensor name, IP address, MAC address, and model number. Sensors can also be added to Favorites.

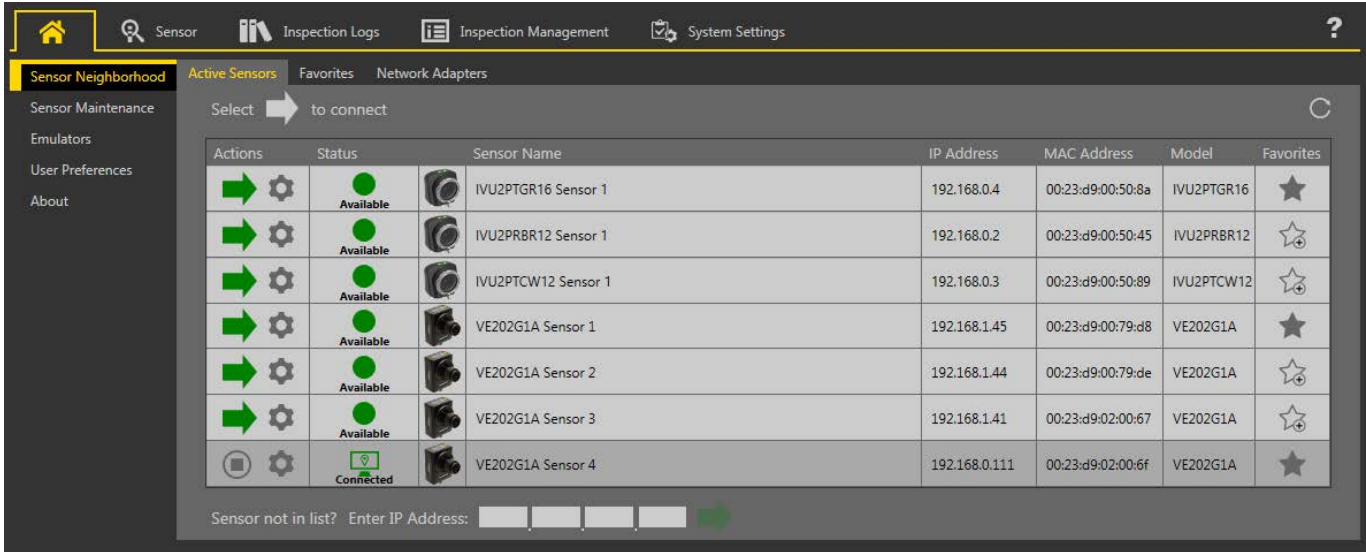
Figure 17. Active Sensors Tab



To connect to a sensor, click  next to the desired sensor. To disconnect from a sensor, click .

To view or change sensor Status, MAC Address, Sensor Name, IP Address, Subnet Mask, and Gateway, click .

To add the sensor to a Favorites Group, click . The icon changes to .

To manually connect to a sensor with a known IP address, enter the IP address in the **Enter IP Address** field and click .



Favorites Tab

Save sensors to the **Favorites** tab for easy access to them. Sensors are saved to groups.

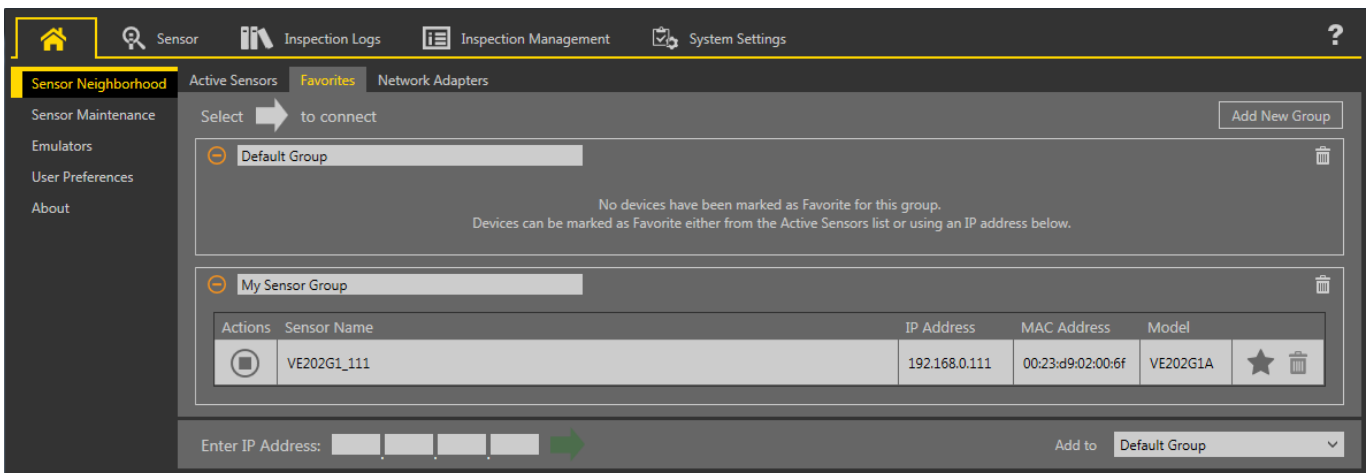

Navigate:  **Home** > **Sensor Neighborhood** > **Favorites**.

Figure 18. Favorites Tab



Click **Add New Group** to create a new Favorites Group. To add a sensor to the group, on the **Active Sensors** tab, click  or from the **Favorites** tab, enter the sensor IP address and click  to verify the connection to the sensor and automatically save it to the selected group.

To manually add a sensor with a known IP address to the **Favorites** tab, enter the IP address in the **Enter IP Address** field and select the desired group.

To remove a sensor from a group, click the  across from the sensor name. To move the sensor to another group, click the  and select the desired group.

To remove a group and all the sensors within the group, click the  across from the group name.

Network Adapters Tab

Use the **Network Adapters** tab on **Sensor Neighborhood** to view the network adapters that the system searches to find sensors.

Navigate:  **Home** > **Sensor Neighborhood** > **Network Adapters**.

Figure 19. Network Adapters Tab

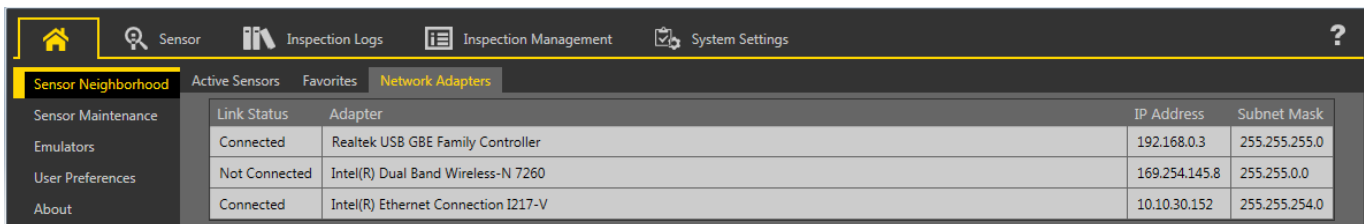

Link Status	Adapter	IP Address	Subnet Mask
Connected	Realtek USB GBE Family Controller	192.168.0.3	255.255.255.0
Not Connected	Intel(R) Dual Band Wireless-N 7260	169.254.145.8	255.255.0.0
Connected	Intel(R) Ethernet Connection I217-V	10.10.30.152	255.255.254.0

Network adapter information including Link Status (connected/not connected), Adapter name, IP Address, and Subnet Mask is also available.

6.1.2 Sensor Maintenance











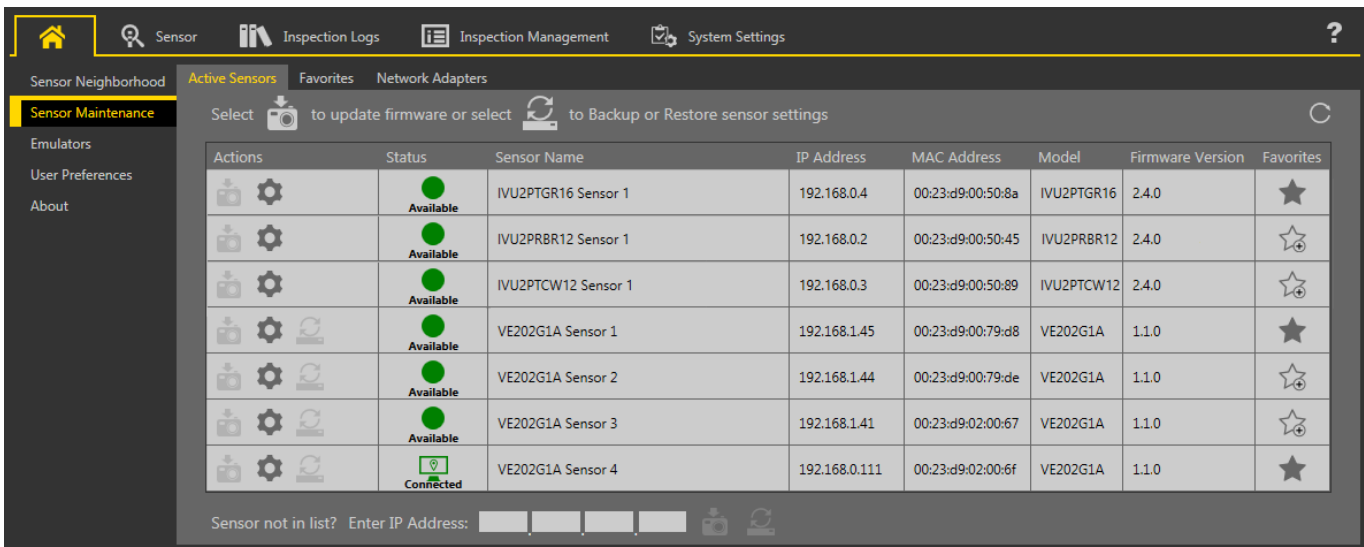















Use **Sensor Maintenance** on the  **Home** screen to update the firmware on a sensor and to backup or restore the sensor.



Figure 20. Sensor Maintenance Tab



Actions	Status	Sensor Name	IP Address	MAC Address	Model	Firmware Version	Favorites
 	Available	IVU2PTGR16 Sensor 1	192.168.0.4	00:23:d9:00:50:8a	IVU2PTGR16	2.4.0	
 	Available	IVU2PRBR12 Sensor 1	192.168.0.2	00:23:d9:00:50:45	IVU2PRBR12	2.4.0	
 	Available	IVU2PTCW12 Sensor 1	192.168.0.3	00:23:d9:00:50:89	IVU2PTCW12	2.4.0	
  	Available	VE202G1A Sensor 1	192.168.1.45	00:23:d9:00:79:d8	VE202G1A	1.1.0	
  	Available	VE202G1A Sensor 2	192.168.1.44	00:23:d9:00:79:de	VE202G1A	1.1.0	
  	Available	VE202G1A Sensor 3	192.168.1.41	00:23:d9:02:00:67	VE202G1A	1.1.0	
  	Connected	VE202G1A Sensor 4	192.168.0.111	00:23:d9:02:00:6f	VE202G1A	1.1.0	

Sensor not in list? Enter IP Address:

Sensor Maintenance includes sensor information such as sensor Status, Sensor Name, IP address, MAC address, Model number, Firmware Version, and which sensors are tagged as favorites.

Actions include update firmware , view or change some sensor settings , and backup or restore sensor data .

Update the Firmware

1. From the  **Home** screen, click **Sensor Maintenance**.

2. Make sure that the desired sensor is not connected to the Vision Manager software and that the status is Available.
3. Click  next to the sensor and follow the prompts.



Note: During the firmware update process, there are options to restore the sensor to the factory default settings and to create a backup before updating the firmware.



Important: All stored inspections are deleted when factory default settings are restored. All user profile information (user names and passwords) is deleted when factory default settings are restored. Ethernet settings and favorites lists are retained.



This process can take several minutes. Do not close the program or remove power from the sensor during the update process.

When the process is complete, the sensor restarts and the status returns to Available. Vision Manager displays the new firmware version in the Firmware Version column.

Backup or Restore the Sensor

System settings, inspections, and user profiles can be backed up and restored. Firmware is not included in the backup or restore.

The backup file is saved to the location of your choice.

1. From the  **Home** screen, click **Sensor Maintenance**.
2. Make sure that no sensors or emulators are connected to the Vision Manager software and that the desired sensor's status is Available.
3. Click , then click **Backup**.
4. Follow the prompts to save a backup file.
A message displays saying that the backup was successful.
5. To restore the sensor data, click , then click **Restore**.
6. Follow the prompts to restore the sensor data. An Emulator backup file can be used to restore the sensor.



Note: This process can take several minutes.



Important: Selecting the **Restore User Profiles** checkbox overrides all of the user names and passwords on the sensor that the restore file is being restored to.

A message displays saying that the restore was successful.

6.1.3 Emulators





Use **Emulators** on the  **Home** screen to connect to the emulator.

Figure 21. Emulators

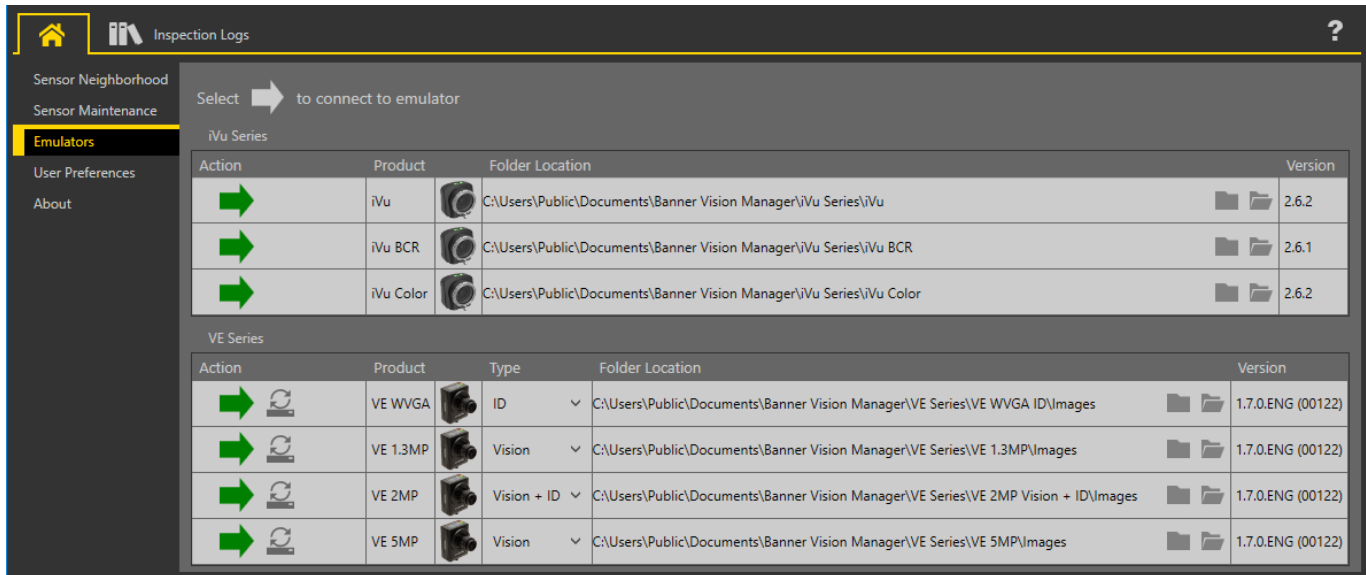

Click  to connect to the desired emulator. This tab also displays the Image location on the computer, as well as the emulator version information.

To access the emulator for different types of the VE models, select the desired type from the **Type** list before clicking . The **Vision** option enables the vision and analysis tools. The **ID** option enables the identification and analysis tools. The **Vision + ID** option enables all tools.



Click  under Folder Location to change the directory for the reference images. The default directory for images is `C:\Users\Public\Documents\Banner Vision Manager\VE Series\VE xMP\Images`. Both 8-bit monochrome bitmap (BMP) images and inspection logs are supported. Bitmap images should be the same resolution as the VE camera. If inspection logs are placed in the Images directory, the emulator automatically extracts the image out of the inspection log and uses it to run the currently loaded inspection. Click  to open the directory.

The **Emulators** tab includes all available features and all tools function the same as they do when running on a sensor. On the emulator, execution time is not calculated.

Backup or Restore the Emulator

Emulator settings and inspections can be backed up and restored.

Save the backup file to the location of your choice.

1. From the  **Home** screen, click **Emulators**.
2. Make sure that no sensors or emulators are connected to the Vision Manager software.
3. Click , then click **Backup**.
4. Follow the prompts to save a backup file.
A message displays saying that the backup was successful.
5. To restore the sensor data, click , then click **Restore**.
6. Follow the prompts to restore the sensor data. A sensor backup file can be used to restore the emulator.



Note: This process can take several minutes.

A message displays saying that the restore was successful.

6.1.4 User Preferences

Use **User Preferences** on the  **Home** screen to set the Vision Manager software language. The language can be changed at any time.

6.1.5 About

Use **About** to view Vision Manager software information, including the version number.

6.2 Sensor Screen

The  **Sensor** screen displays the information needed to create or modify an inspection.

Figure 22. Sensor Screen

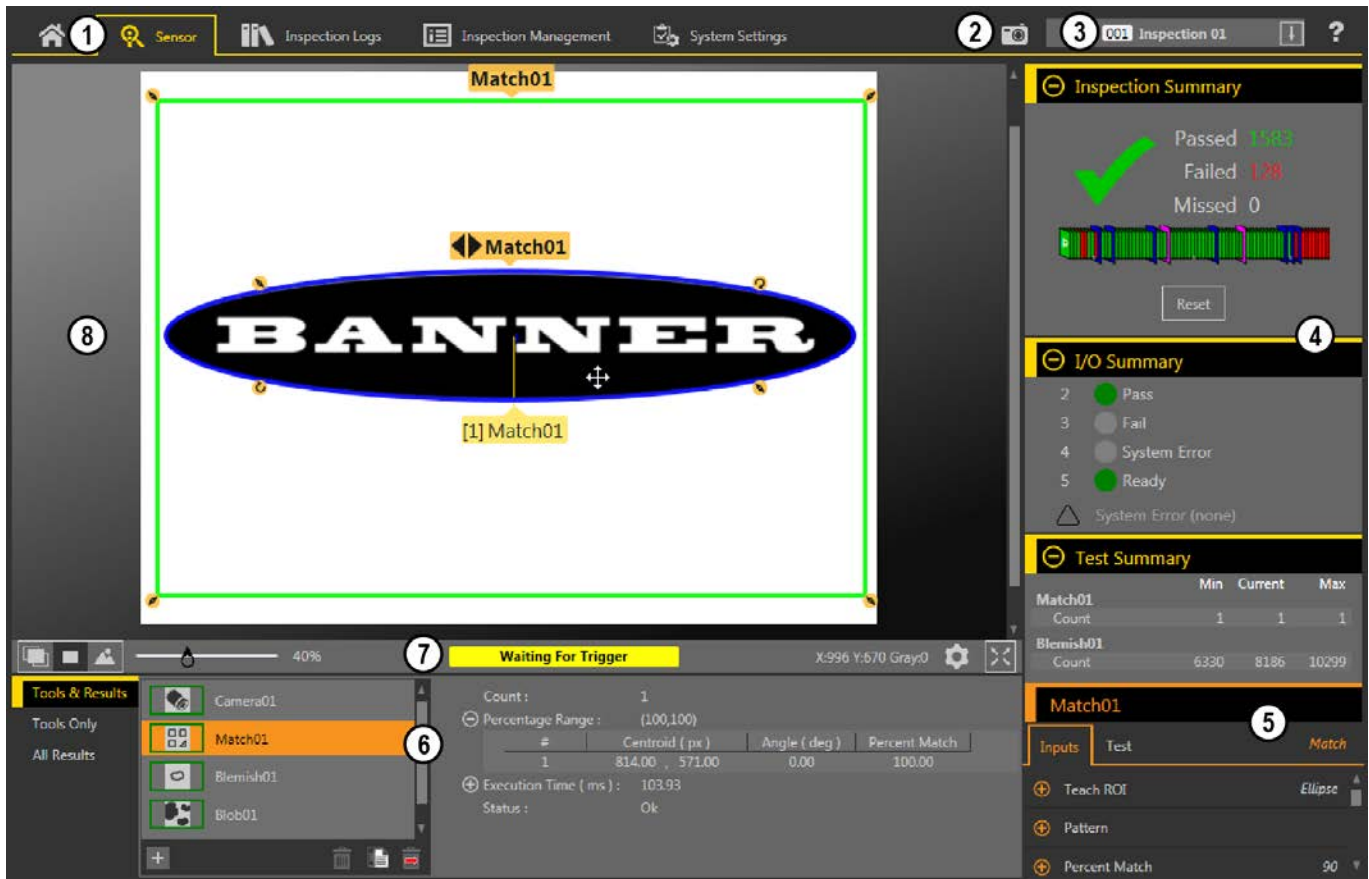

1. Screens—**Home, Sensor, Inspection Logs, Inspection Management, System Settings**
2. **Manual Trigger** button—Click to manually trigger the sensor
3. **Inspection** list—Select the desired inspection to start, and to view or modify the inspection
4. **Summary** pane—Includes the Inspection Summary, the I/O Summary, and the Test Summary
5. **Parameters** pane—Includes user-adjustable Inputs parameters or Test parameters for the tools in an inspection, depending on what is selected in the **Tools and Results** pane
6. **Tools and Results** pane—Includes **Tools and Results, Tools Only,** and **All Results,** which display the camera tool, the tools that are included in the current inspection, and the results of the inspection
7. **Image Pane Parameters** panel—Includes ROI view buttons, zoom, x and y coordinates, grayscale value, settings button, and full image display button, as well as sensor messages
8. **Image** pane—Displays the current image captured by the sensor; this includes the region of interest (ROI) for the tool for the selected inspection



6.2.1 Image Pane Parameters

Use the **Image Pane Parameters** to change how the Image pane displays and to view status messages.

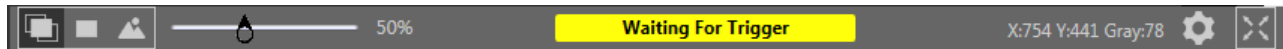
Figure 23. Image Pane Parameters



ROI View Buttons

- Click  to view all tool ROIs and annotations.
- Click  to view the ROI and annotations for the selected tool only.
- Click  to hide all ROIs annotations and view the image only.



Note: The **Image Overlays** parameter for each tool also control which ROI is shown and this parameter overrides the ROI view buttons.

Zoom

Slide to zoom the Image pane in and out.



Status Messages

View status messages such as "Applying Changes" and "Waiting for Trigger". Some messages, such as "Applying Changes," display only momentarily while a parameter change is serviced by the sensor. Other messages, such as "Waiting for Trigger", require an action to be completed.



X and Y Coordinates and Grayscale Value



Displays the current x and y coordinates and grayscale value for the location the pointer is at in the **Image** pane.

Settings Button

- Click  to change some ROI settings.
 - Change the size of the ROI labels
 - Change the opacity of the background of the ROI labels
 - Show or hide controls (change ROI shape, add a mask) in the labels, where applicable
 - Change the size of the sizing handles 

Full Image Display Mode Button

Click  to expand the image to fill the screen. The image pane, image pane parameters, as well as passed, failed, and missed counts are shown. Click  to return to the standard view.

When in Full Image Display Mode, click  to view the Test Summary Results and click  to hide the Test Summary Results.

6.2.2 Summary Pane

The **Summary** pane includes the **Inspection Summary**, the **I/O Summary**, and the **Test Summary**.

Inspection Summary

When expanded, the **Inspection Summary** displays inspection pass, fail, and missed trigger statistics since the last time the inspection summary results were reset.

A green checkmark indicates that an inspection passed, and a red X indicates that an inspection failed. A dash indicates that there is no information to display.

Figure 24. Inspection Summary

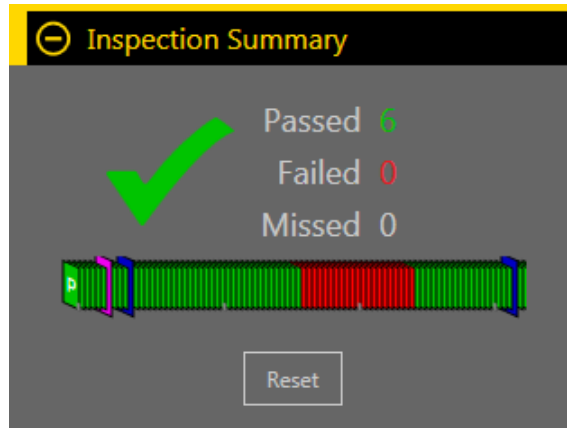

The History Trend below the pass/fail statistics provides another visual indication of whether or not an inspection passed, as well as an indication of when changes are made.

- Green indicates that an inspection passed
- Red indicates that an inspection failed
- Blue indicates that a change was made to the inspection
- Pink indicates that a product change was made—either a new inspection was added or the inspection was changed to a different one

The History Trend holds up to 400 entries and updates after an inspection is completed. The entries are recorded first in, first out, with the newest entry displayed on the left of the History Trend. Point to an entry on the History Trend for information about the entry. For example, pointing to a green entry displays the frame number.

Click **Reset** to clear the **Inspection Summary** statistics. The History Trend does not reset.

When collapsed, the **Inspection Summary** displays only pass and fail information. The green number on the left represents the number of inspections that passed. The red number on the right represents the number of inspections that failed since the last reset.

I/O Summary

When expanded, the **I/O Summary** displays input and output status information and system errors, if present.

When collapsed, no **I/O Summary** information is visible.

Figure 25. I/O Summary

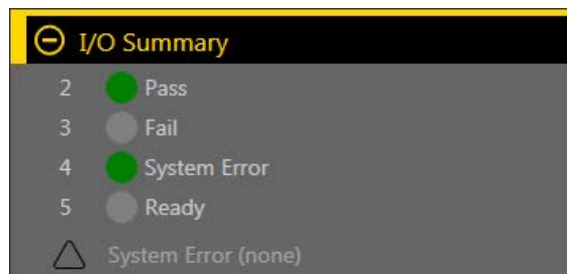

Inputs and outputs display on the **I/O Summary** after they are configured from the  **System Settings** screen (see [Configure the Discrete I/O](#) on p. 22). Green indicates that the I/O is active. Light gray indicates that the I/O is inactive.

The System Error indicator flashes red when an error is present. View and clear the error from the  **System Settings** screen (see [Logs](#) on p. 45).

Figure 26. IO Summary with Error



Test Summary

When expanded, the **Test Summary** shows results from the enabled Test parameters for each tool in the current inspection. Failures are highlighted in red.

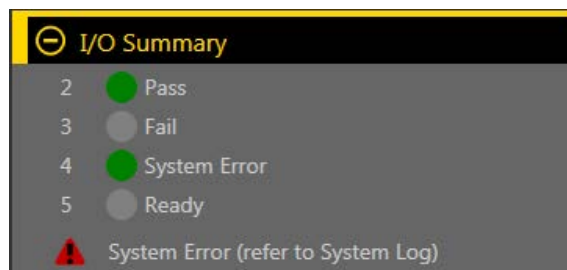
When collapsed, no **Test Summary** information is visible.

Figure 27. Test Summary with a Failure

	Min	Current	Max
Match01			
Count	1	1	1
Blemish01			
Count	6330	6350	10299
Blob01			
Count	11	11	11
Total Area	16,617.55	13,795.00	20,926.89

6.2.3 Tools & Results

Tools & Results shows the camera tool and the inspection tools that are included in the current inspection, as well as the results for the currently selected tool.

Figure 28. Tools & Results

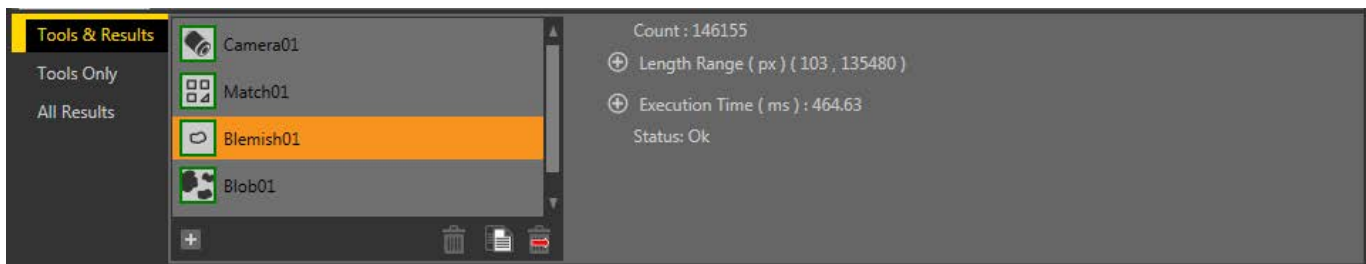

Use **Tool & Results** to add and configure tools in an inspection and to view results. Click a camera tool or inspection tool on **Tools & Results** to access the **Parameters** pane for that camera or tool. Click in the empty area below the tools to view information about the inspection, such as Inspection Name and Execution Time. If Data export is enabled, the available data also displays.

Figure 29. Tools & Results—Data Export Shown

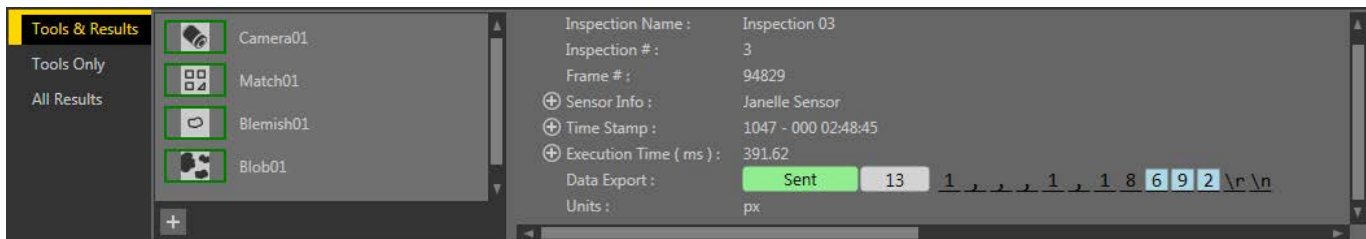

See [Using the Camera Tool](#) on p. 57, [Using the Inspection Tools: Vision Tools](#) on p. 61, [Using the Inspection Tools: ID Tools](#) on p. 138, and [Using the Inspection Tools: Analysis Tools](#) on p. 149 for additional tools information. See also [Data Export Tab](#) on p. 43.

6.2.4 Tools Only

Tools Only shows the camera tool and the inspection tools that are included in the current inspection.

Figure 30. Tools Only



Use **Tools Only** to add and configure tools in an inspection. Click a camera tool or inspection tool on **Tools Only** to access the **Parameters** pane for that camera or tool.

See [Using the Camera Tool](#) on p. 57, [Using the Inspection Tools: Vision Tools](#) on p. 61, [Using the Inspection Tools: ID Tools](#) on p. 138, and [Using the Inspection Tools: Analysis Tools](#) on p. 149 for additional tools information.

6.2.5 All Results

All Results lists the results for the current inspection, camera tool, and inspection tools.

Figure 31. All Results

Tools & Results		Result	Time	Pass Count	Fail Count
Tools Only	+ Inspection 05	Pass	719.20	15356	135
All Results	+ Camera01	Ok	47.51	89	0
	+ Match01	2	146.97	89	0
	+ Blemish01	145612	464.62	89	0
	+ Blob01	116	60.02	89	0

At a glance, view the Result (pass/fail/status), execution Time (in milliseconds), Pass Count, and Fail Count for each item. Expand each item for additional details.

6.3 Inspection Logs Screen

The  **Inspection Logs** screen displays saved images and inspection information. Inspections logs can be viewed when the camera is offline.



Figure 32. *Inspection Logs Screen*

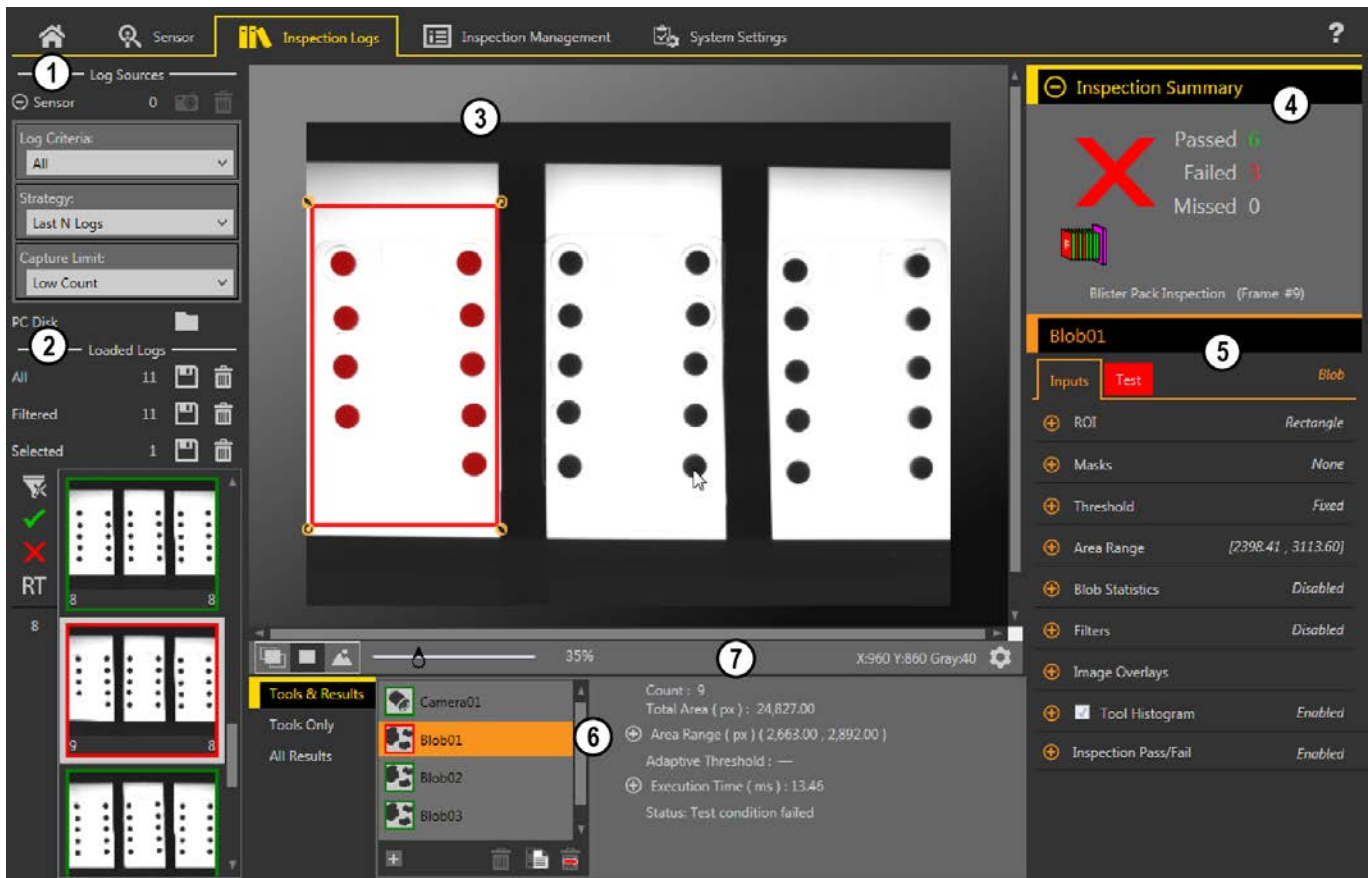

1. **Log Sources** pane—Choose the source for the inspections logs to view, and set the criteria for collecting logs
2. **Loaded Logs** pane—View and filter the inspection logs
3. **Image** pane—Displays the saved inspection image captured by the sensor. This includes the tools that were used in that inspection
4. **Summary** pane—Displays saved information from a specific inspection and frame number
5. **Parameters** pane—Displays the logged Input or Test parameters, depending on what is selected in the **Tools & Results** pane
6. **Tools and Results** pane—Includes the **Tools & Results** tab, the **Tools Only** tab, and the **All Results** tab, which display the camera tool, the tools that are included in the logged frame, and the results of the inspection
7. **Image Pane Parameters** panel—Includes ROI view buttons, zoom, x and y coordinates, grayscale value, and the ROI label settings button, as well as sensor messages

6.3.1 Log Sources

View logs from either the sensor or a network folder or storage device.

Click  to move the inspection logs from the sensor to the computer. Click  to navigate to saved inspection logs. Thumbnail views of the images display in the **Loaded Logs** pane. While inspection logs are loading, the **Percent Bar** displays and shows the percentage of inspection logs that have loaded; it is removed when all inspection logs have finished loading.

Expand **Sensor** to set the criteria for what is collected in the inspection logs. Set the **Log Criteria**:

- All
- Pass Only

- Fail Only
- By Slot Number
- Remote Teach All
- Remote Teach Pass
- Remote Teach Fail

Set the **Strategy**:

- First N Logs
- Last N Logs

Set the **Capture Limit** (limits the number of inspection logs the sensor holds in internal memory):

- Low Count
- Medium Count
- High Count

Filter logs to be viewed by pass , fail , remote teach **RT**, or inspection number using the buttons to the left of the inspection previews. Click  to clear all filters.

6.3.2 Loaded Logs

After log information is loaded from the **Log Sources** pane, click on a thumbnail to view the full frame in the **Image** pane.

The **Inspection Summary** shows whether or not the inspection passed, which inspection was being used, which frame number you are viewing, and the system and inspection CRCs. Click the camera tool or an inspection tool in the **Tools and Results** pane to view additional logged information in the **Parameters** pane, such as camera exposure, the reference pattern, or the filters used during the inspection, as well as to view specific results for the frame.



Note: Some parameters are disabled in the **Inspection Logs**. For example, if histogram information was not collected during the inspection, it cannot be viewed from the log.

6.4 Inspection Management Screen

The  **Inspection Management** screen includes options to add inspections to the currently connected sensor, to rename an inspection, and to transfer inspections between a connected sensor and a network location or storage device.

The following are available from the **Inspection Management** screen:

- Manage
- Transfer

The inspection CRC is listed for each inspection on both the Manage and Transfer screens. When an inspection is created, it is assigned a Cyclic Redundancy Check code, or CRC. The CRC is generated by considering each setting within the inspection (this includes the input parameters of all tools). When a change is made to the input parameters of any tool within the inspection, a new CRC is generated. Because of this, CRC becomes a very simple yet powerful way to determine if a change was made to the inspection since the last time it was modified.



Note: Changing an inspection's name and slot number does not modify its CRC.

The system CRC is available on the **System Settings** tab.

6.4.1 Manage

Use **Manage** to add new inspections, delete existing inspections, rename inspections, set an inspection to run at startup, or copy an inspection.

Figure 33. Manage

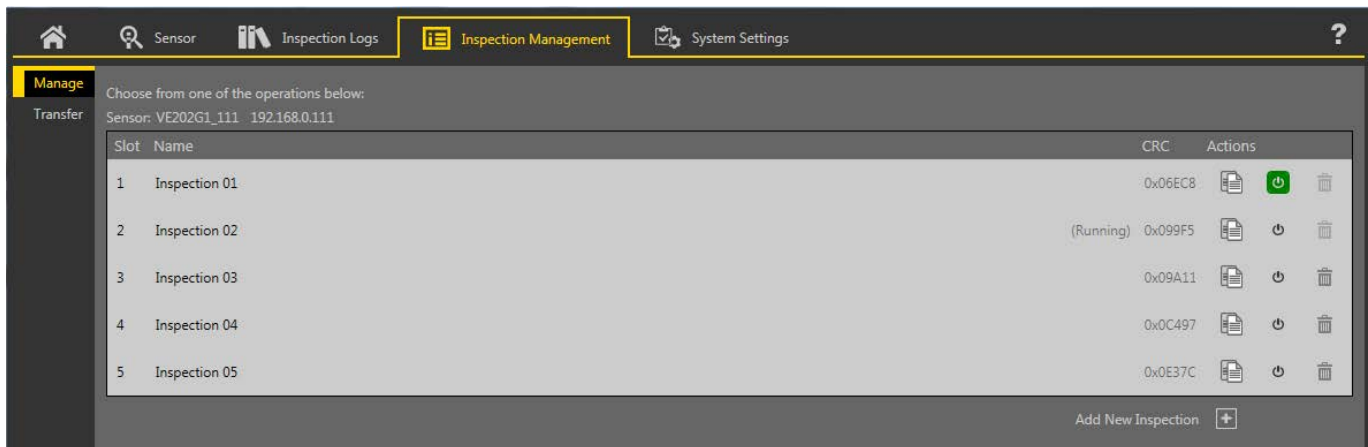

Also displayed are the sensor name, inspection name, and whether the inspection is running.

Copy an Inspection

Duplicate (copy) an inspection to use as a starting point for a new inspection.

1. On the **Inspection Management** screen, click **Manage**.
2. Locate the inspection to copy and click . A duplicate of the inspection is created with the same tools and parameters and is added to the inspection list as *Inspection (#)*.
3. Adjust the inspection as desired. The two inspections are not linked; changes are independent of each other.

Delete an Inspection

1. Click **Inspection Management**, then click **Manage**.
2. Select the inspection to be deleted.



Note: This inspection cannot be running and it cannot be selected to begin at startup.

3. Click . The inspection name turns red and "Inspection marked for deletion" displays.

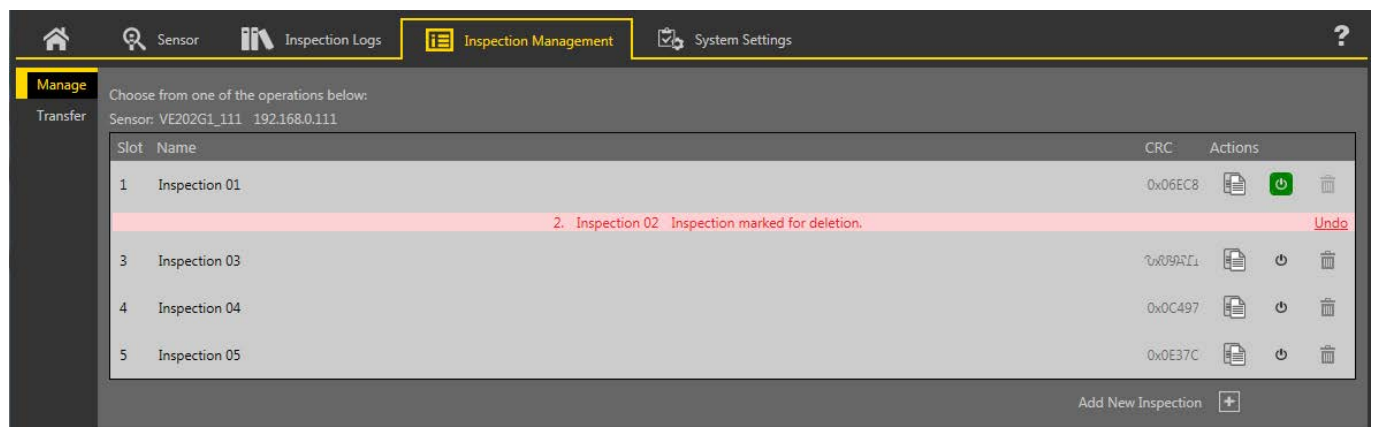

Figure 34. Inspection Marked for Deletion



4. Click to another tab to delete the inspection, or click **Undo** to keep the inspection.

Set an Inspection to Begin at Startup

 **Note:** Only one inspection can begin at startup.

1. On the  **Inspection Management** screen, click **Manage**.
2. Locate the desired inspection and click .
The  turns green and the inspection will begin at the next startup.

6.4.2 Transfer

Use **Transfer** to transfer inspections between a connected sensor and a computer, network drive, or storage device.

Figure 35. Transfer

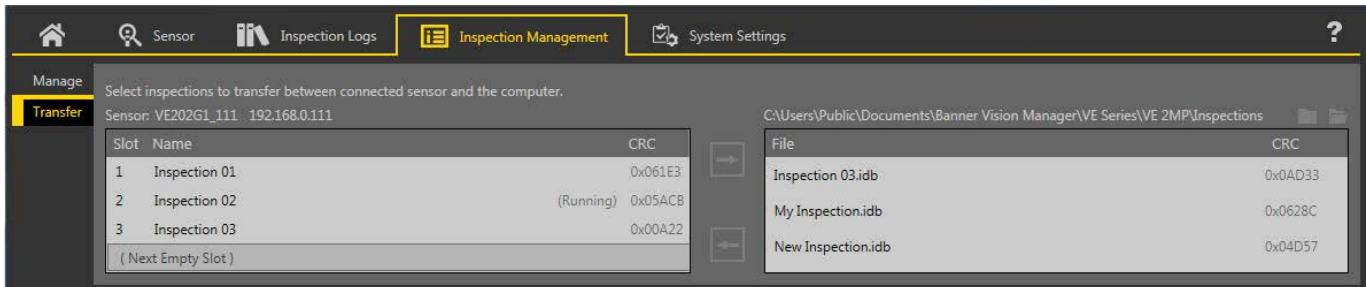

Click  to navigate to and select a different folder. Click  to open the folder to view the files.

Save an Inspection to a Computer, Network Drive, or Storage Device



Vision Manager automatically saves inspections to the VE as they are created and modified. Save a copy of the inspection to your computer or another network location if you want to be able to go back to previous settings.

Use the following procedure to save a copy of an inspection to your computer or a network location.

1. On the  **Inspection Management** screen, click **Transfer**.

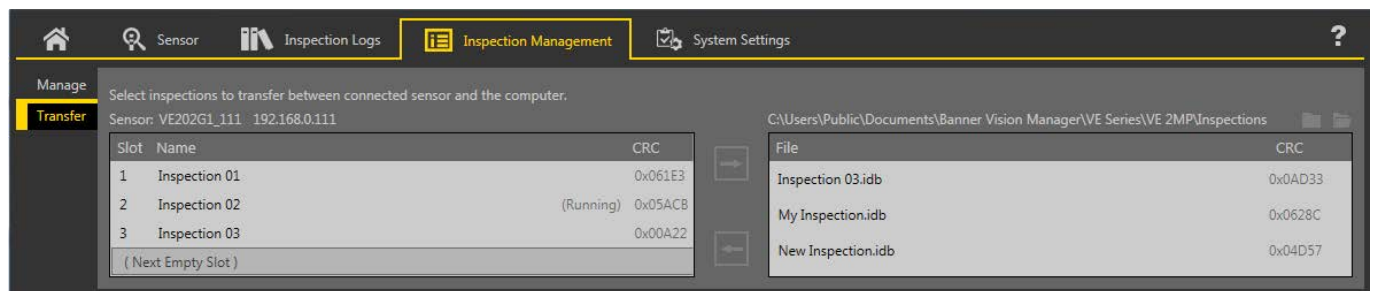

Figure 36. Transfer



2. Change the destination folder, if desired.
 - a) Click  above the right column.
An explorer window opens.
 - b) Navigate to the desired location, network location, or storage device.
 - c) Click **Select Folder**.
The folder is selected and the window closes.
The path to the location displays above the right column.
3. Select the desired inspection from the inspection list in the left column.
4. Click .
Inspection name.idb displays in the right column and the inspection is transferred (saved) to the selected location.

Save Inspections to a VE Sensor

Inspections stored on a computer or network drive or created in the emulator can be saved to the connected VE sensor.

1. On the  **Inspection Management** screen, click **Transfer**.
2. Select the desired location.
 - a) Click  above the right column.
 - b) Navigate to the desired folder.
The path to the location displays above the right column.
3. In the list on the left, select **(Next Empty Slot)** to add the inspection to the list or select an existing inspection to replace.
4. Select the desired inspection from the list on the right.
5. Click .
Inspection name displays in the left column and the inspection is transferred to the sensor.

6.5 System Settings Screen

The  **System Settings** screen provides access to view and adjust sensor information, discrete I/O, communications settings, system logs, and units.

The following are available from the **System Settings** screen:

- Sensor Info
- Discrete I/O
- Communications
- Logs
- Units
- User Profiles
- System Reset

6.5.1 Sensor Info

Use **Sensor Info** to view or change sensor information, including sensor name, IP address, subnet mask, and gateway.

Figure 37. Sensor Info

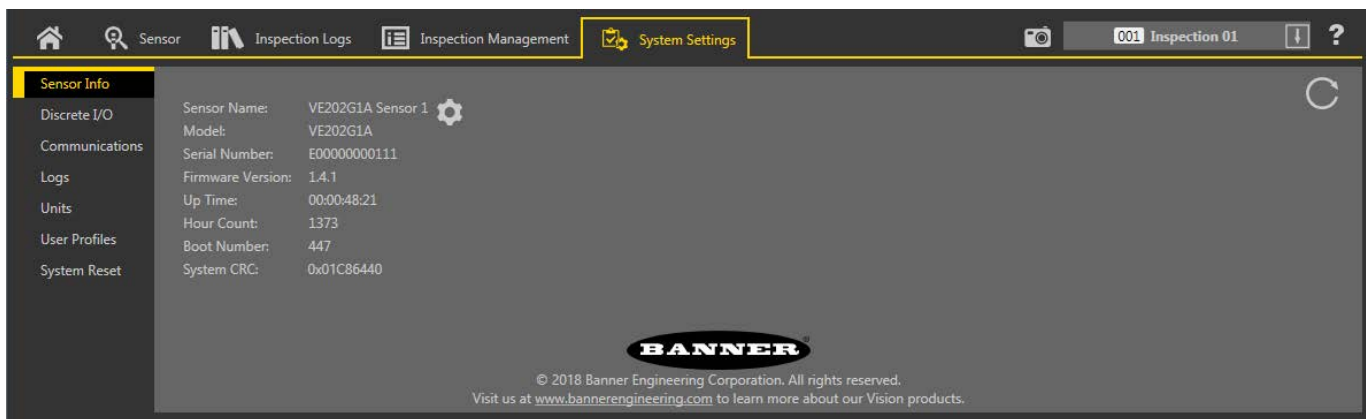

Click  to access the sensor properties editing window. Click  to refresh the information.

- Sensor Name—View or change the sensor name
- Model—View the model number of the sensor
- Serial Number—View the serial number of the sensor
- Firmware Version—View the current firmware version of the sensor
- Up Time—View the amount of time the sensor has been running since it was last powered on
- Hour Count—View the number of hours the sensor has been powered on over its lifetime
- Boot Count—View the number of times the sensor has been powered on over its lifetime
- System CRC—View the current system CRC number

The system Cyclic Redundancy Check code, or CRC is listed on the **System Settings > System Info** tab. The CRC is generated by considering each setting within the system. When a change is made to the system parameters (including a change to the inspection CRC) a new CRC is generated. Because of this, CRC becomes a very simple yet powerful way to determine if a change was made to the system since the last time it was modified.



Note: Changing the following sensor features and information does not modify the system CRC:

- Sensor IP address
- Sensor subnet mask
- Sensor gateway
- Sensor name
- Sensor Serial Number
- Sensor Mac Address
- User Profile changes
- Updated pattern in match tool if remote teach feature was used to change it
- Updated data compare string in the barcode tool if remote teach feature was used to change it

The inspection logs show which CRC an image was acquired under. The system CRC is available to a PLC and can be sent using Data Export on all protocols.

The inspection CRC is available on the **Inspection Management** tab.

6.5.2 Discrete I/O

Use **Discrete I/O** to view the I/O and pin numbers; view the status; and set the function, active level, output delay, latch type, and output duration for each pin.

From the **System Settings** screen, select **Discrete I/O** to change the discrete I/O settings.

Figure 38. Discrete I/O

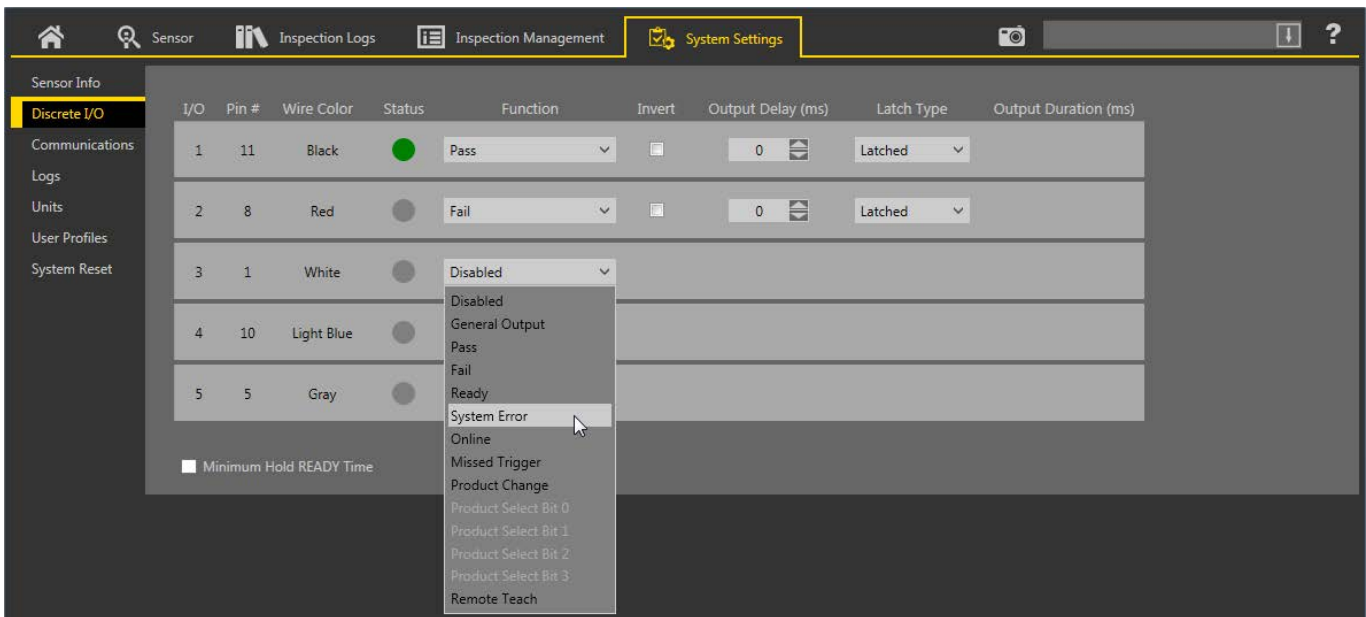

I/O

The VE has five configurable I/O. These are pins 1, 5, 8, 10, and 11.

Pin

The pin number on the cable connection. See [Table 1](#) on p. 14.

Wire Color

The corresponding wire color for each pin. See [Table 1](#) on p. 14.

Status

Indicates whether or not the I/O is active.

Green = active

Gray = inactive

Function

The following input and output options are available:

- Disabled—The pin is not configured
- General Output—Used in conjunction with the Logic Tool to configure individual discrete outputs based on specific tool results
- Pass—Active when the inspection passes
- Fail—Active when the inspection fails
- Ready—Active when the sensor is ready to accept another trigger
- System Error—Active when a system error occurs
- Online—Active when the Camera is connected
- Missed Trigger—Active when a trigger is missed
- Product Change—The input is used in conjunction with one of the four I/O points programmed as Product Select lines. The inspection loaded will be executed following a valid trigger. See [Function: Product Change](#) on p. 39 for additional details on Product Change
- Product Select Bit 0/1/2/3—Available when Product Change is selected on another I/O; used in conjunction with Product Change to select inspection locations at which to begin execution. See [Function: Product Change](#) on p. 39
- Remote Teach—Sets the pin to accept input pulses for remote teaching the sensor. See [Using Remote TEACH with the Match Tool](#) on p. 130 and [Using Remote TEACH with the Barcode Tool Data Compare Test](#) on p. 145

Invert

Select to switch when the I/O is active or inactive.

Output Delay (ms)

The time from when a trigger starts an inspection until the sensor output turns on. It is available for the General Output, Pass, Fail, and Missed Trigger functions of the selected pin.



Note: If the inspection execution time is longer than the output delay, the output becomes active immediately after the processing is finished.

Latch Type

Select the behavior of the I/O pin when in the active state; available when the I/O is configured as an output.

- Latched—Maintains state until the condition of the associated function changes; available for the following functions: General Output, Pass, Fail, Ready, System Error, Online, and Missed Trigger
- Pulsed—Maintains active state for a selected period of time, then returns to the inactive state; available for the following functions: General Output, Pass, Fail, System Error, and Missed Trigger
- Trigger Gated—Output signal is only active upon trigger signal being active
- Latched Until Trigger—Maintains state until a new trigger is received; available for the following functions: General Output, Pass, Fail, and Missed Trigger

Output Duration (ms)

The length of time the output is active.

This option is available for the Latch Type = Pulsed.

Minimum Hold READY Time

When checked, this option holds the READY signal inactive for at least this minimum duration after receiving a valid trigger.

Function: Product Change

The sensor can be commanded to load inspections from slots 1 to 15 using the combination of Product Change and Product Select functions of the discrete I/O pins.

Set the state of the Product Select pins as described in [Product Select Inputs](#) on p. 39. Then set the state of the Product Change pin to Active when the sensor is in the Ready state. The sensor immediately loads the selected inspection and is ready to execute when it receives a trigger. For Product Change to be successful, select at least one of the I/O pins to function as Product Select.

Product Select Inputs

The VE has four dedicated Product Select lines that can be thought of as making a Binary Code Decimal (BCD) table. Access inspections 0 through 15 using the following pin combinations:

Inspection Number	Product Select #3	Product Select #2	Product Select #1	Product Select #0
0	OFF	OFF	OFF	OFF
1	OFF	OFF	OFF	ON
2	OFF	OFF	ON	OFF
3	OFF	OFF	ON	ON
4	OFF	ON	OFF	OFF
5	OFF	ON	OFF	ON
6	OFF	ON	ON	OFF
7	OFF	ON	ON	ON
8	ON	OFF	OFF	OFF
9	ON	OFF	OFF	ON
10	ON	OFF	ON	OFF
11	ON	OFF	ON	ON
12	ON	ON	OFF	OFF
13	ON	ON	OFF	ON
14	ON	ON	ON	OFF
15	ON	ON	ON	ON

6.5.3 Communications

Use **Communications** to view or change communication information, to set the industrial protocol, and to set image export, data export, and serial connection settings.

Ethernet Settings Tab

Use the **Ethernet Settings** tab to view or change some Ethernet settings.

Navigate: **System Settings** > **Communications** > **Ethernet Settings**.

Figure 39. Ethernet Settings Tab

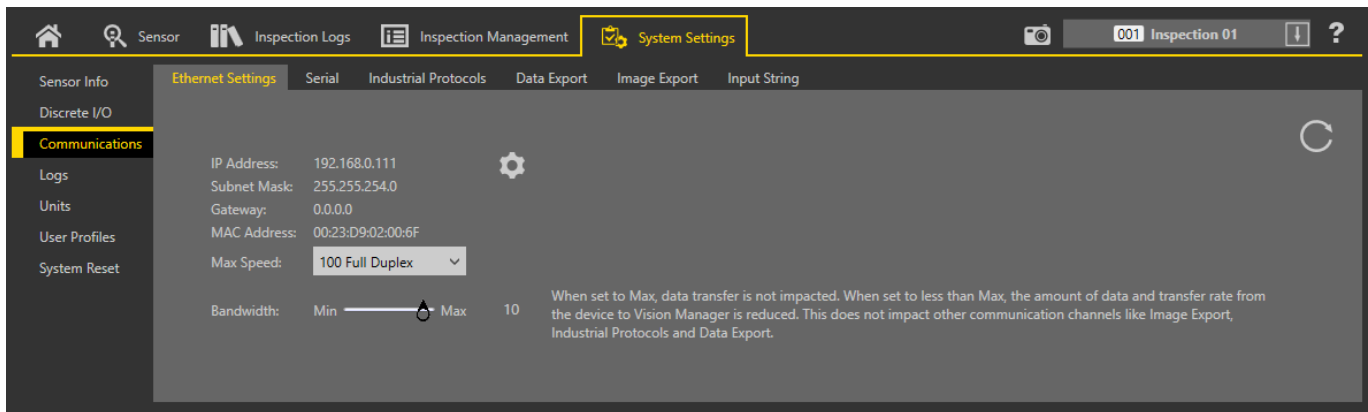

On the **Ethernet Settings** tab, click to access the sensor properties editing window and view or change the following:

- IP Address—View or change the IP address of the sensor
- Subnet Mask—View or change the subnet address of the sensor
- Gateway—View or change the gateway address of the sensor
- MAC Address—View the MAC address of the sensor

Max Speed

To change the **Max Speed**, the maximum negotiation speed with the network, select the desired speed from the list:

- 1000 Full Duplex
- 100 Full Duplex (default)
- 100 Half Duplex

Bandwidth

To change the **Bandwidth**, use the slider to set the desired setting. The default is **Max (10)**.

The bandwidth setting allows for controlling the network traffic between the VE and the Vision Manager software, and impacts the viewing rate on the **Image** pane as well as the time it takes to load the inspection logs from the sensor to the computer. This does not impact other communication channels, such as Image Export, Industrial Protocols, or Data Export.

When set to **Max**, data transfer is not impacted. When set to less than **Max**, the amount of data and the transfer rate from the device to the Vision Manager software is reduced. For example, setting the bandwidth to a low number reduces the network traffic, increasing the time it takes to load the logs, but does not affect the sensor's basic operation (inspection time, communication with a PLC, etc.).

Due to variations in each network, test several bandwidth settings to find the one that works best for your network and needs.

The **Bandwidth** setting is available with VE firmware version 1.8.0 and later.

Serial Tab

Use the **Serial** tab to configure the serial connection.

Navigate:  **System Settings > Communications > Serial.**

Figure 40. Serial Tab

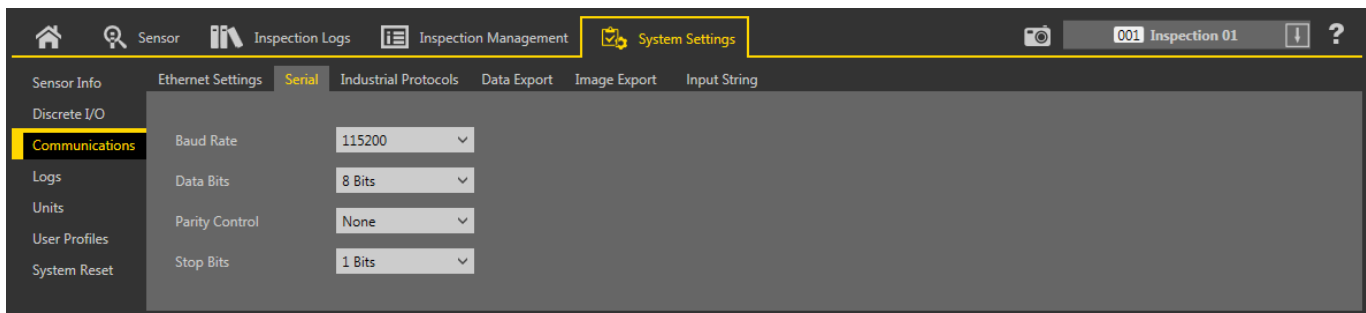

The serial connection is used with the Data Export function. It uses pins 4 and 12. Pin 4 is RS-232 TX (transmit) and pin 12 is RS232 RX (receive). On the **Serial** tab, set the following parameters to match the receiving device:

Baud Rate

- 115200 (default)
- 57600
- 38400
- 28800
- 19200
- 9600

Data Bits

- 8 bits (default)
- 7 bits

Parity Control

- None (default)
- Even
- Odd

Stop Bits

- 1 Bits (default)
- 2 Bits



Note: Because there is no flow control for the serial connections, the sensor will not detect or log a lost or broken connection.

Industrial Protocols Tab

Use the **Industrial Protocols** tab to set the protocol the sensor uses to communicate and to select output data (map) to send to a PLC.

Navigate: **System Settings > Communications > Industrial Protocols.**

Figure 41. Industrial Protocols Tab

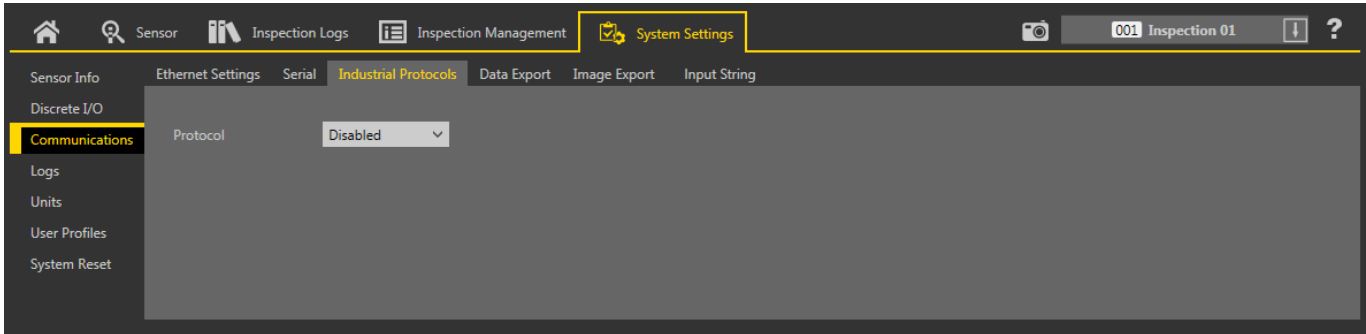

On the **Industrial Protocols** tab, select the desired protocol to enable it.

- Disabled (default)
- EtherNet/IP
- PROFINET
- Modbus/TCP
- PCCC

A **32 Bit Format** setting displays if Ethernet/IP, Modbus/TCP, or PCCC is chosen. Select **LSW-MSW** or **MSW-LSW** from the list.

Figure 42. Industrial Protocols Tab—EtherNet/IP Selected

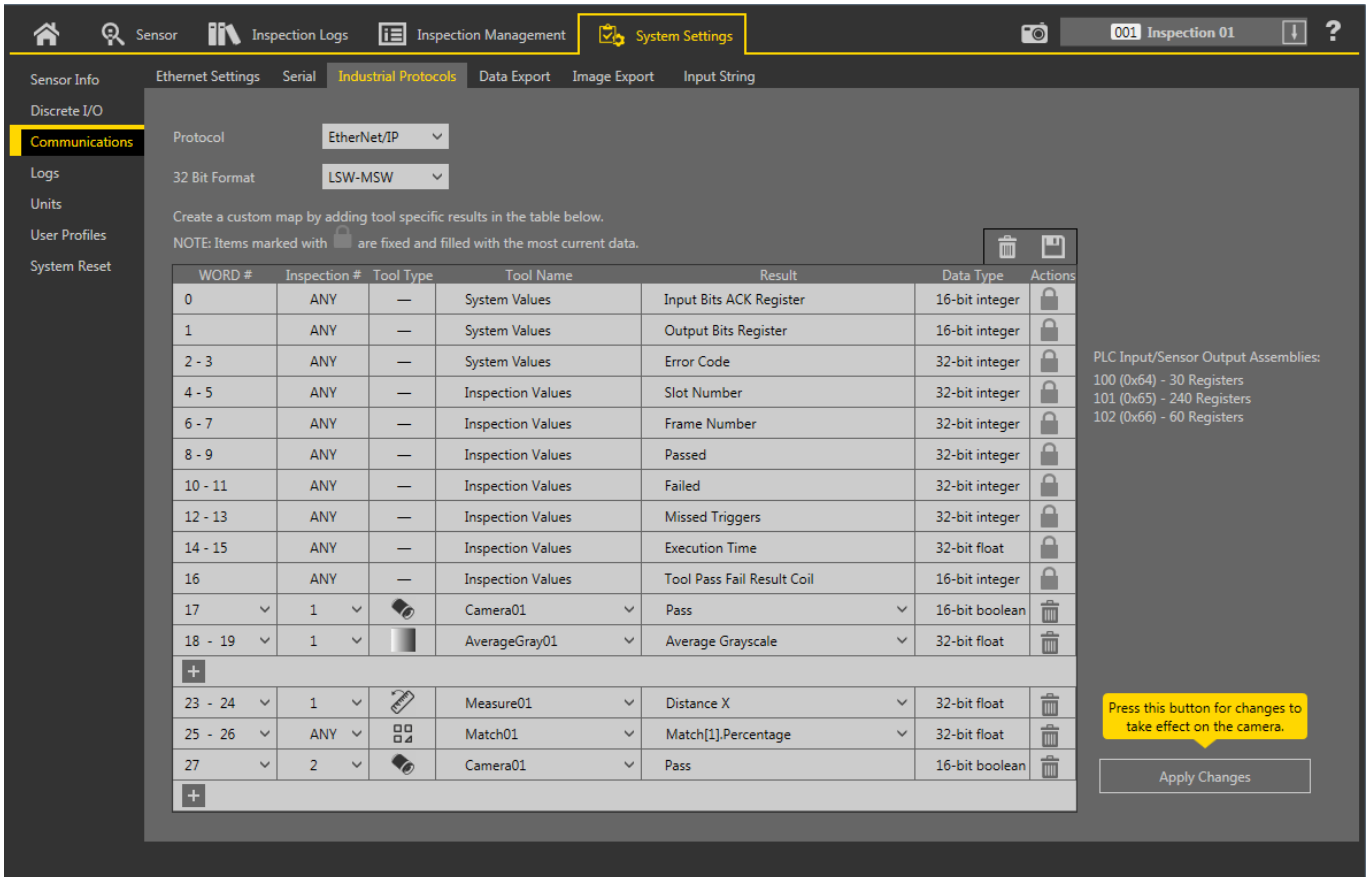

A customizable map to output camera or inspection tool-specific results also displays. The map includes the following:

- Register/Byte/Word (depending on the protocol selected)



- Inspection #
- Tool Type
- Tool Name
- Result
- Type
- Actions

Note:

- Inspection # changes automatically depending on which inspection includes the tool.
- Type changes automatically depending on how much space is available.
- Data in registers 1–16 are fixed and contained in the PLC input assemblies (EtherNet/IP, Modbus/TCP, and PCCC).

Click **Apply Changes** to send the current map to the camera.

Click  to print and save a PDF of the current map. The PDF includes all data, whether system-defined or user-defined.

Click  above the map to return the map to the default settings. All user-defined output data is deleted. Click  in the Actions column to delete an individual result.

For additional information see:

- [Set the Industrial Ethernet Protocol \(EtherNet/IP, PROFINET, Modbus/TCP, PCCC\)](#) on p. 177
- [Tool-Specific Results: EtherNet/IP](#) on p. 184
- [Tool-Specific Results: Modbus/TCP](#) on p. 205
- [Tool-Specific Results: PCCC](#) on p. 216
- [Tool-Specific Results: PROFINET](#) on p. 224

Data Export Tab

Use the **Data Export** tab to set the parameters used to export inspection results.









Navigate:  **System Settings > Communications > Data Export.**

Figure 43. Data Export Tab

On the **Data Export** tab, set the data export parameters, including which results to export, which channel to use, and the port number to use. Note that the port number cannot be the same as any other port in use.

Use the data export map to select the results to publish. Use  to add additional entries at the end of the list. Click  or  to add additional entries above or below the currently selected entry. Use  and  to move an entry to either up or down in the map.

Click  above the map to return the map to the default settings. All user-defined output data is deleted. Click  in the Actions column to delete an individual entry.

Shown below the map is the data that is currently available to be exported.

The Frame Format settings are located to the right of the map and include the desired delimiter, start string, and end string. The Missing Data Format settings are also located to the right of the map. These settings include the option to publish filler characters in place of data that is missing in the current inspection. If **Fill String** is selected, enter the desired filler characters in the **Fill String** field. Different filler characters can be published for missing numeric data or missing string data. For additional information, see [Data Export](#) on p. 169.

Image Export Tab

Use the **Image Export** tab to set the parameters used to export images.

Navigate:  **System Settings > Communications > Image Export.**

Image Export is disabled by default. On the **Image Export** tab, set which images to export, then select the method.

Export

Set which images to export:

- **Disabled** (default)
- **All**
- **Pass only**
- **Fail only**

Ethernet Protocol

Choose which protocol to use to export images:

- **TCP/IP**
- **FTP**

Figure 44. TCP/IP Settings

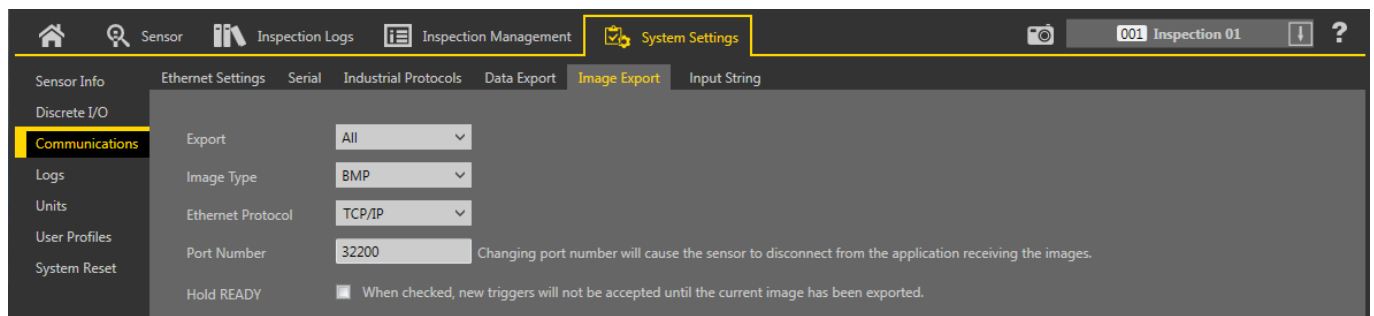
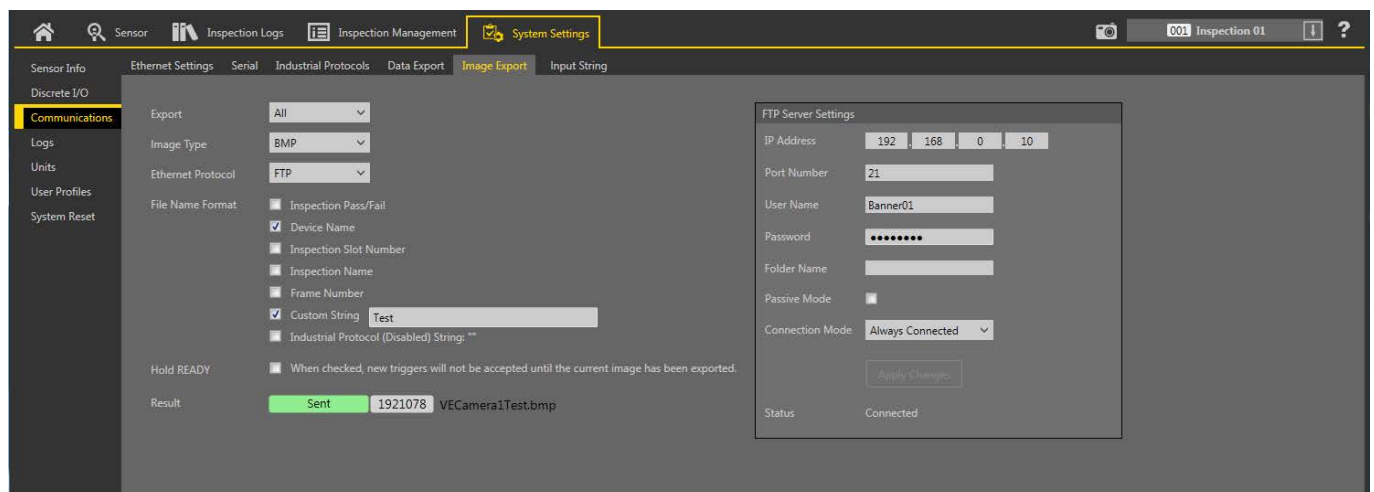

Figure 45. FTP Settings



See [Image Export: TCP/IP](#) on p. 171 and [Image Export: FTP](#) on p. 173 for more information.

Input String Tab

Use the **Input String** tab to set the parameters used to send information to the sensor from an external Ethernet source. If desired, export the data using Data Export.

Navigate:  **System Settings > Communications > Input String.**

Figure 46. Input String Tab



Input String is disabled by default. On the **Input String** tab, configure the **Port Number**, **String Header**, and **String Footer** to enable the sensor to receive an input string. For example, a VIN number supplied by a PLC to the sensor. This aids in traceability. The string value is set only through the Ethernet source, not in Vision Manager. The maximum size, including the header, content, and footer, is 50 bytes.

For additional information, see [Input String: TCP/IP](#) on p. 175.

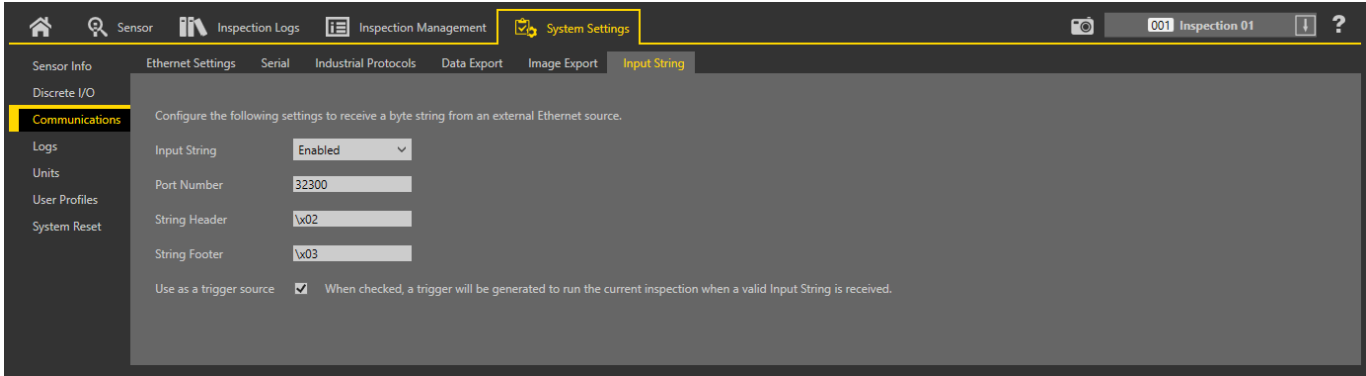
6.5.4 Logs

The **Logs** default view is the **System** tab. Use the **System Tab** to view, export, or clear system logs and communication logs. Select or clear the **Display** checkboxes to customize which events are shown.

Navigate: **System Settings > Logs > System**.

Figure 47. System Tab

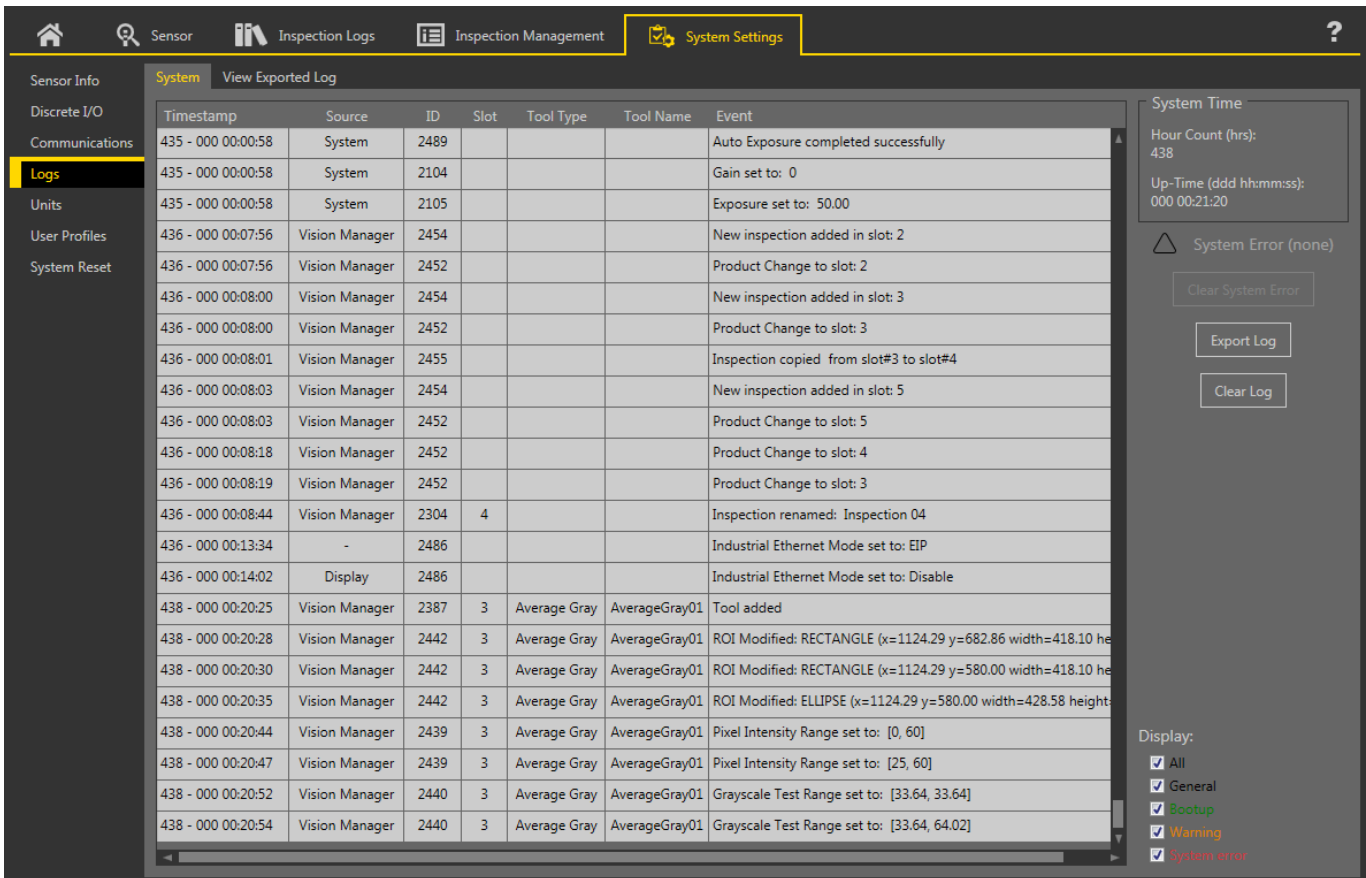

To clear a system error flag (or state), click **Clear System Error**.



Note: The system error log entry will not be cleared from the log.

To export system logs, click **Export Log** and follow the prompts. Logs are exported as a .slog file.

To clear the log, click **Clear Log**.

View a system log exported from another sensor using the **View Exported Logs** tab.

Navigate: **System Settings > Logs > View Exported Log**. Click **Load Log** and navigate to the desired log file to view it.

Figure 48. View Exported Log Tab

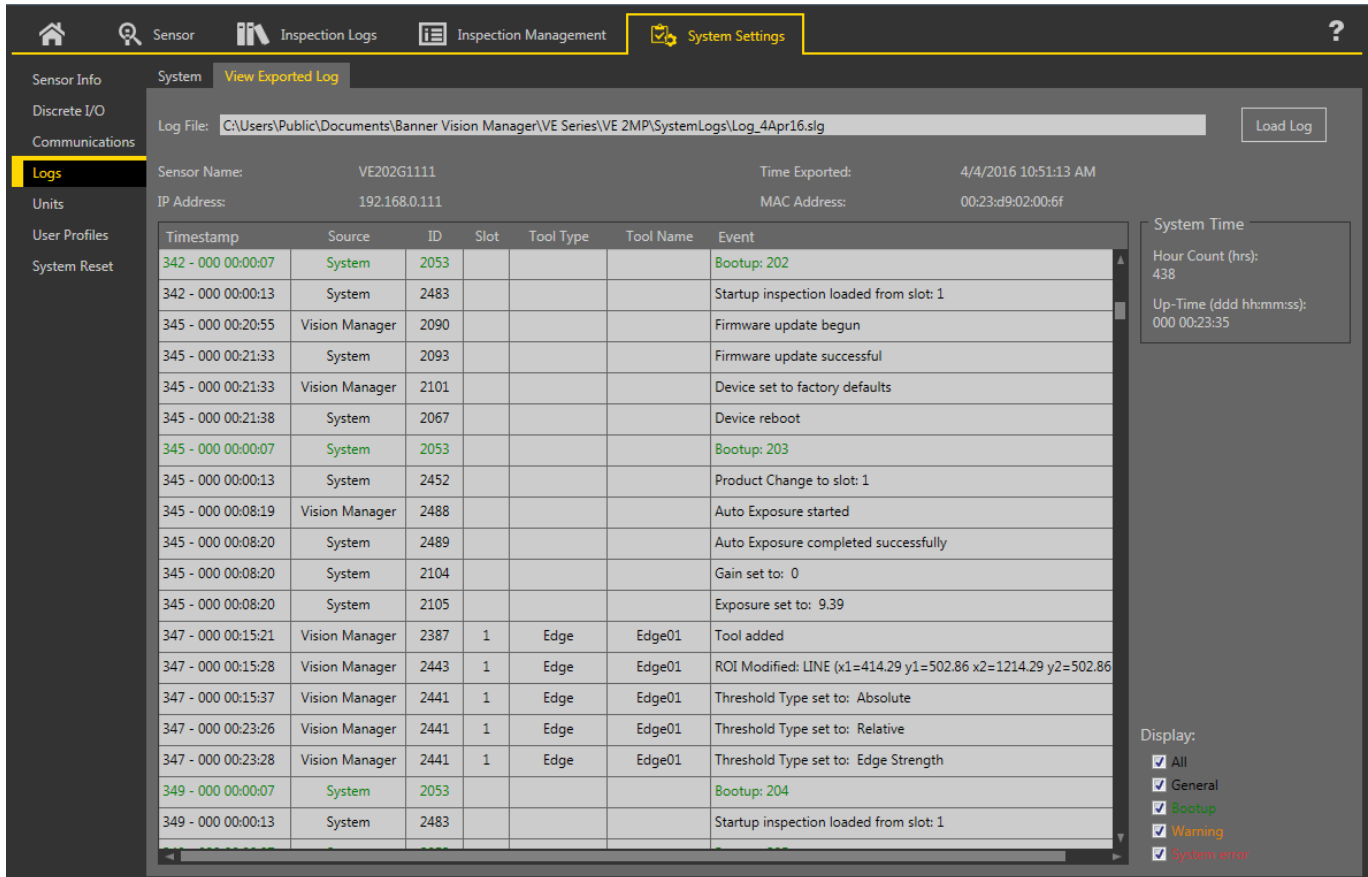

6.5.5 Units

Use **Units** to select a unit to display, to adjust the precision, or to perform a perspective correction.

The VE Series Smart Camera computes tool distance and area values in units of pixels. The **Scaling** mode allows users to convert pixels to user defined measurements units (for example, millimeters).

When the camera is not perpendicular to the part being inspected there is a natural perspective distortion, causing tool distance and area values to vary across the image. The **Perspective Correction** mode addresses this situation.

Perspective Correction can also be used to adjust the camera's native coordinate system, for example matching the coordinate system of a robot interfacing with the camera.

Use **Precision** to set the number of decimal places used in Distance and Area tool results.

Units and Calibration

Use **Units and Calibration** to select a unit to display, to adjust the precision, or to correct for perspective distortion.

Select either **Scaling** or **Perspective Correction** from the **Mode** list.

Figure 49. Units and Calibration

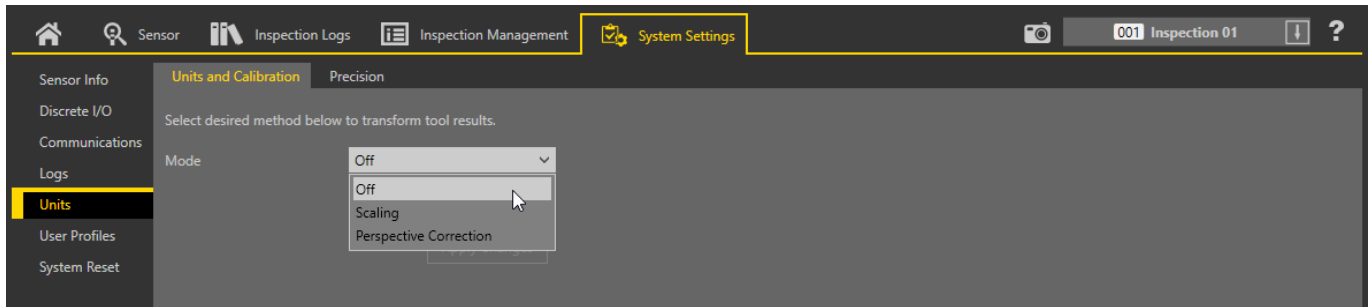

Scaling

Use the **Scaling** mode to select a unit to display and to publish results that represent distance, size, and location calculations.

Navigate: **System Settings** > **Units** > **Units and Calibration**, then select **Scaling** from the **Mode** list.

Figure 50. Scaling

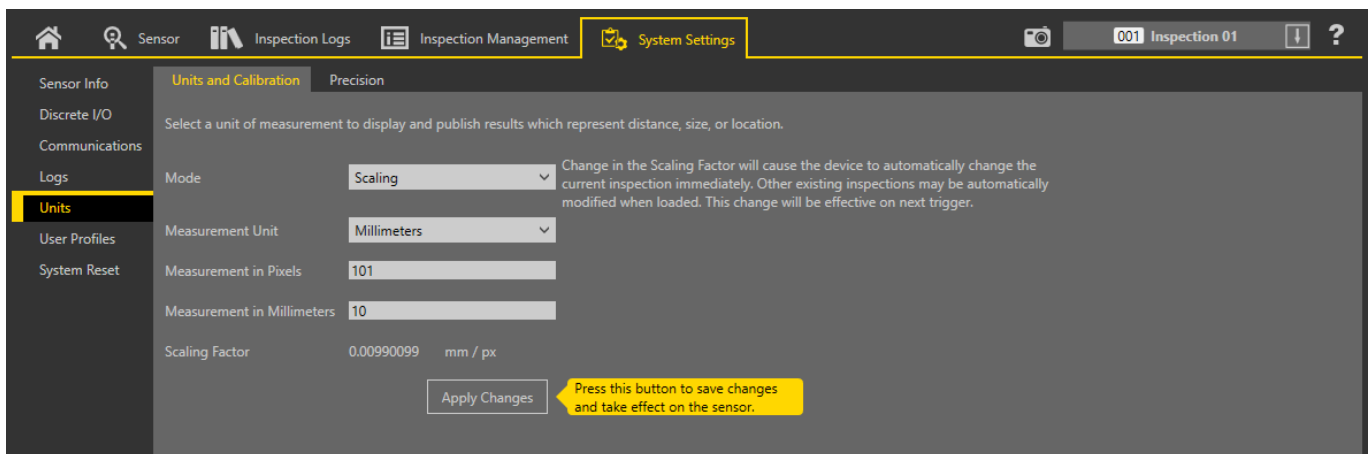

By default, distance, size, and location calculations are shown in pixels. To change the displayed units, select the desired measurement unit and parameters. The following Measurement Units are available:

- Microns (μm)
- Millimeters (mm)
- Centimeters (cm)
- Meters (m)
- Mils (mil)
- Inches (in)
- Feet (ft)
- Yard (yd)

Click **Apply Changes** to save the changes. Applying a scaling factor changes the measurements listed in the **Tools and Results** to the selected unit and applies the scale to all inspections.

Scale Units Using a Known Measurement

Use a known measurement, such as ruler, to configure the scaling factor for converting pixels to the desired unit.

The conversion factor for using scaled units can be determined using any object of a known size. For illustration purposes, this example uses a ruler as the object.



Note: This procedure is an example only.



Note:

- Make sure the camera focus is as sharp as possible
- Span more pixels for increased accuracy
- Use objects closer to the center of the FOV to limit the distortion that naturally occurs closer to the edges of the FOV

1. Place the ruler in the FOV.
2. Add a Measure tool.
3. Point to the 0 line on the ruler and write down the x and y coordinates shown in the Image Parameters pane.

Figure 51. X and Y Coordinates

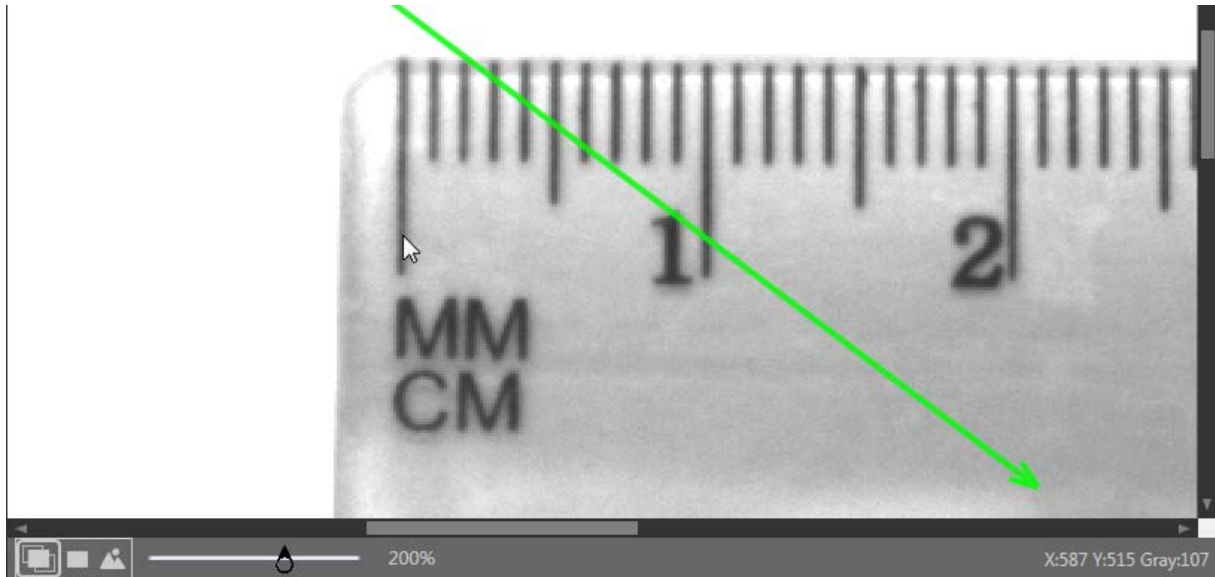

4. Expand **Measure from...** and select **Constant**.
5. In the **Point (X, Y)** field, enter the x and y coordinates from step 3.
6. Point to the 10 mm (1 cm) line on the ruler and write down the x coordinate shown in the Image Parameters pane.
7. Expand **Measure to...** and select **Constant**.
8. In the **Point (X, Y)** field, enter the x you wrote down in step 6 and y coordinate from step 3. (The y coordinates must be the same.)
The Measure tool measures between the two points.
9. Write down the Distance (px) show in **Tools & Results**.
In this example, the distance is 101.00 px.

Figure 52. Distance Measurement Between the Two Points

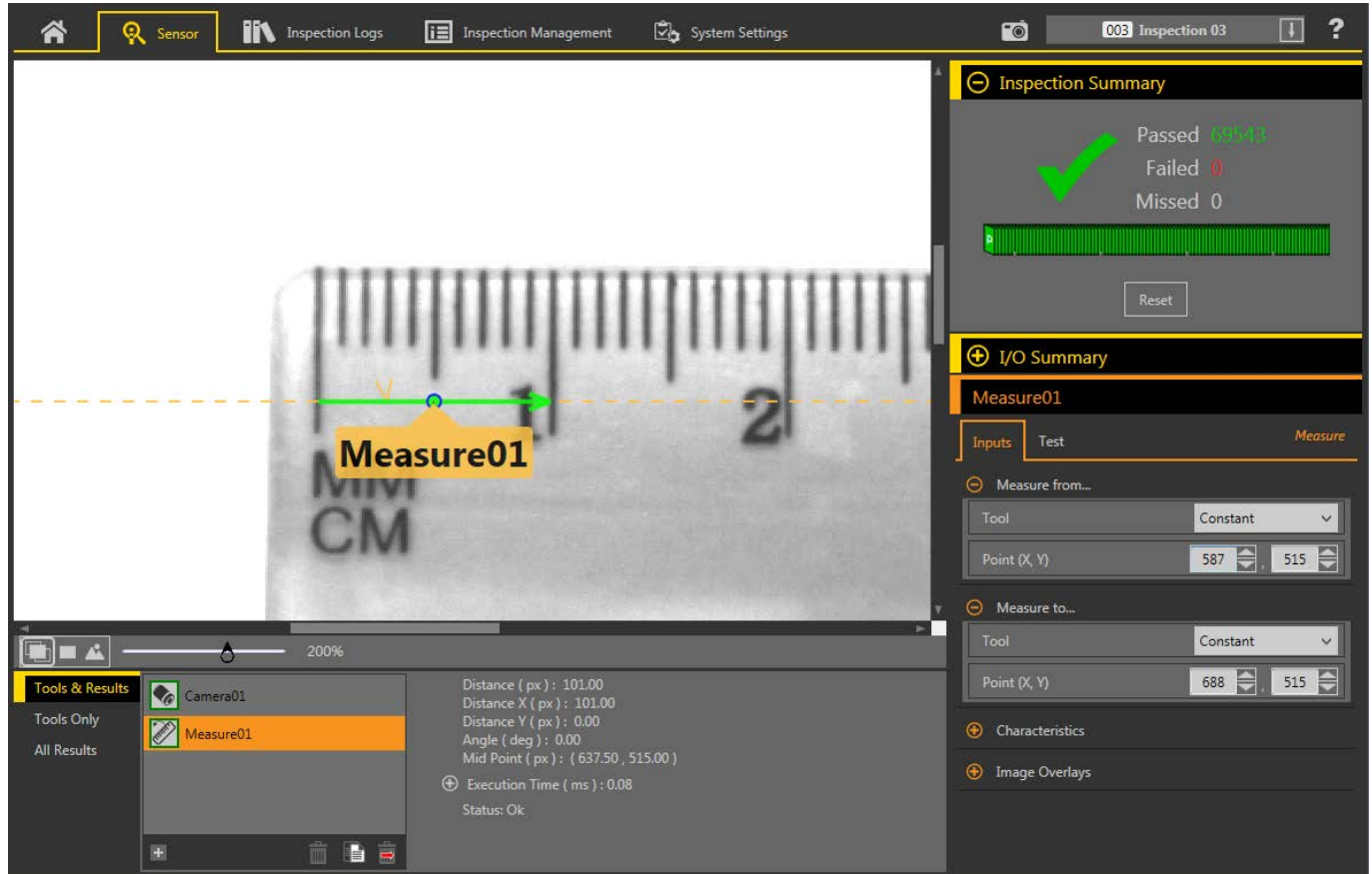

10. On the **System Settings** screen, click **Units**.
11. From the **Mode** list, select **Scaling**.
The scaling parameters display.
12. Select the desired **Measurement Unit**. For this example, the unit is Millimeters.
13. In the **Measurement in Pixels** field, enter the distance from step 9.
14. In the **Measurement in Millimeters** field, enter 10 because the known distance was 10 mm.

Figure 53. Scaling

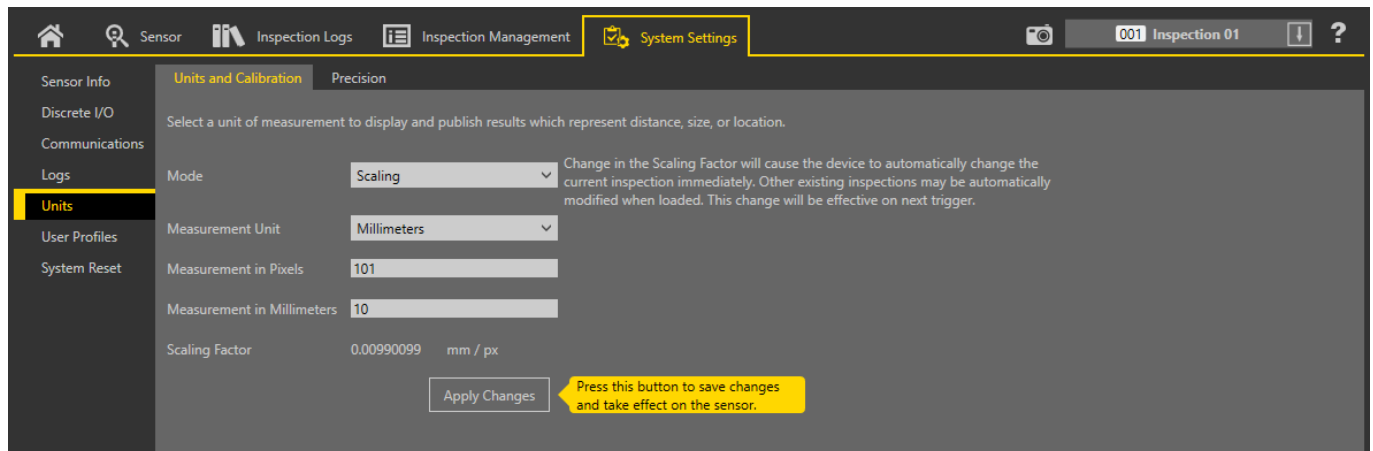

15. Click **Apply Changes**.
Applying a scaling factor affects all existing inspections. The currently running inspection is immediately modified on the next trigger and other inspections are modified when they are loaded.

Figure 54. Tools and Results Showing the New Units

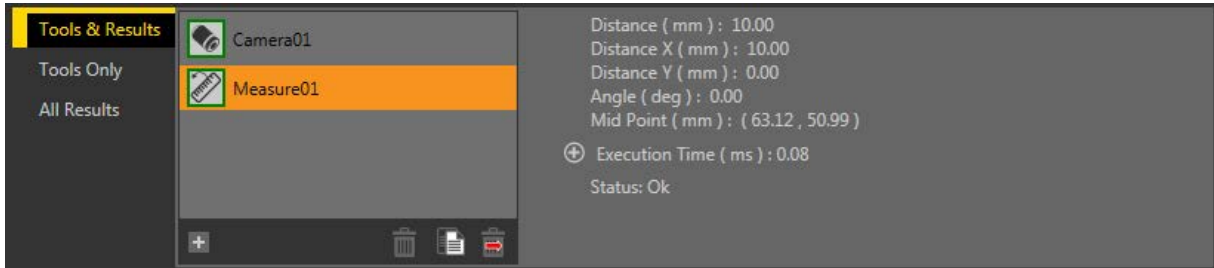

Perspective Correction

Use the **Perspective Correction** mode to enter real world coordinates, select a unit to display, and publish results which represent locations and angles (except Blob Major Axis Angle).

Navigate: **System Settings > Units > Units and Calibration**, then select **Perspective correction** from the **Mode** list. While configuring the perspective correction, inspections are suspended.

Figure 55. Perspective Correction

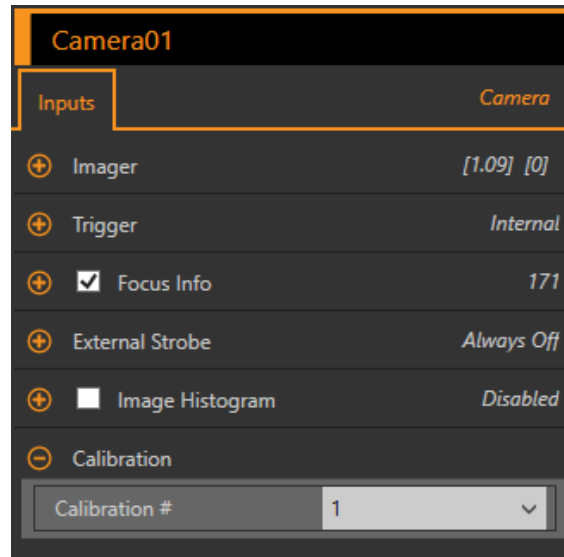

The **Inspection** list changes to a **Calibration** list. Up to five perspective corrections (calibrations) can be stored. Select the appropriate **Calibration #** from the **Inputs** parameters on the **Camera** tool found on the **Sensors** tab. By default, the first calibration created is applied to all inspections (this does not apply to the Emulator).

Figure 56. Perspective Correction **Calibration** Parameter

When **Perspective Correction** is used, **All Results** includes information about the **Units**.

Figure 57. All Results

Tools & Results	Result	Time	Pass Count	Fail Count
Tools Only				
All Results				
Inspection 01	Pass	31.43	30641	0
Inspection Name : Inspection 01 Slot : 1 Frame # : 60760 Sensor Info : VE202G1A Sensor 1 CRC : 0x891A Time Stamp : 2550 - 000 01:41:47 Execution Time (ms) : 31.43 Units : mm Mode : Perspective correction Scaling Factor : 0.41 mm / px Calibration # : 1				

Using Perspective Correction

Follow these steps for an example use of **Perspective Correction** mode.
Cancel the process at any time by clicking **Abort**.



Note: This procedure is an example only.

- Go to **System Settings > Units > Units and Calibration**, then select **Perspective Correction** from the **Mode** list.



Important: Inspections are suspended during this time.

- If needed, set the Exposure, Gain, or Auto Exposure on the **Inputs** parameters pane. These settings are saved with the Calibration.
- Select the desired measurement unit from the **Real World Unit** list. This example uses millimeters.
- If desired, click to add additional calibration points. This example uses a fifth point. Up to 20 points can be added.
- Move the P1, P2, P3, P4, and P5 calibration points to the desired location on the image. The points should be spread out and accurately placed in the desired region of measurement. When a calibration point is selected, the corresponding row in the Real World Coordinates table is highlighted.

Figure 58. Points Spread Out and Accurately Placed on the Image

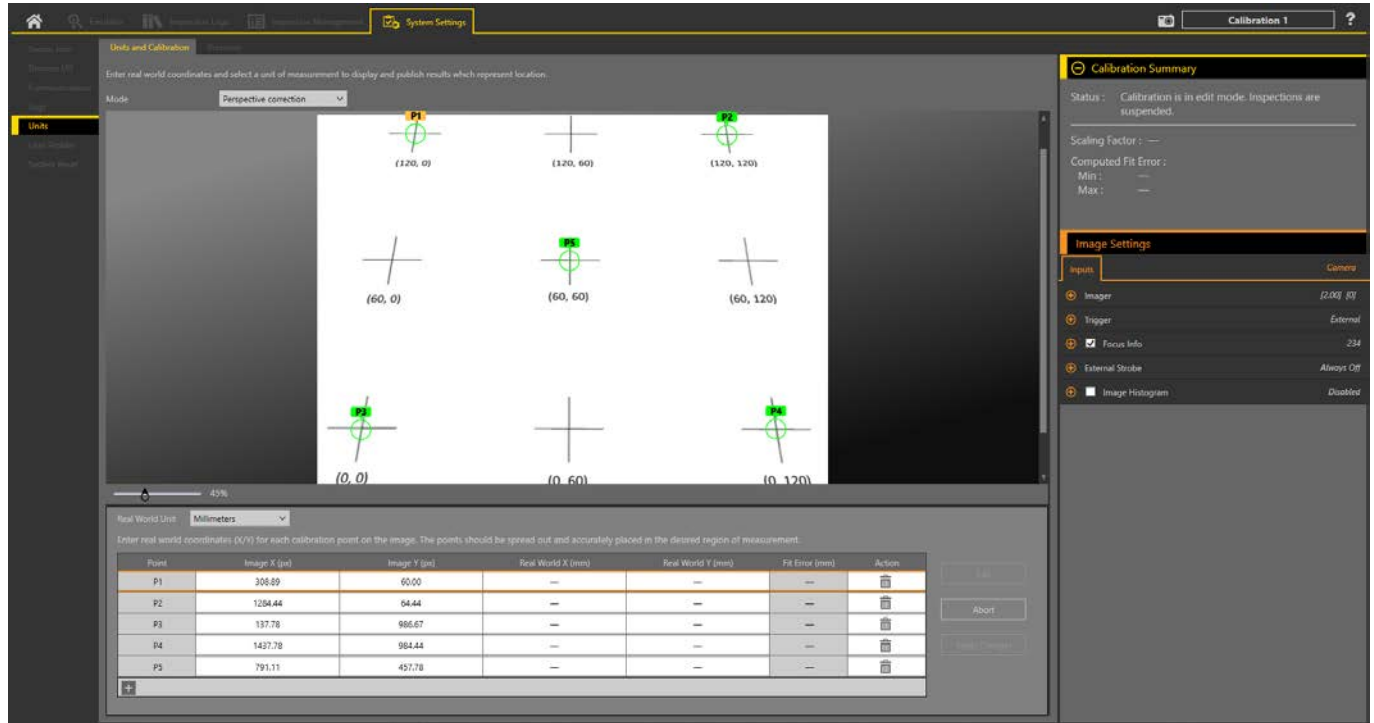

6. In the Real World Coordinates table, enter the corresponding actual coordinates for each calibration point.

Figure 59. Real World Coordinates

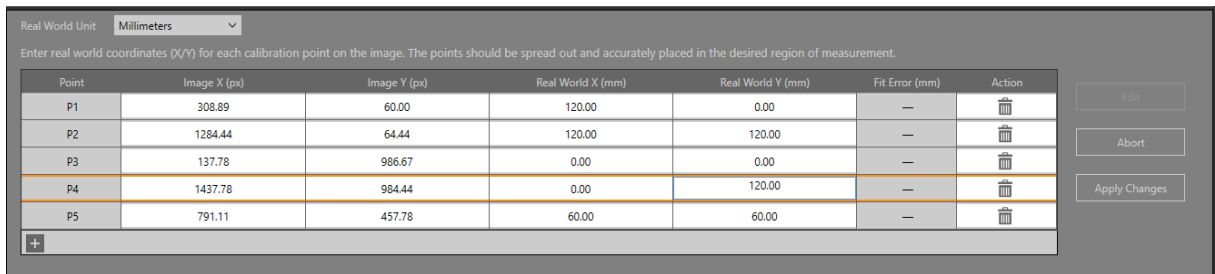

7. Click **Apply Changes**.

The **Calibration Summary** pane updates to show the status, scaling factor, and other information, including the Computed Fit Error.

Figure 60. Calibration Summary

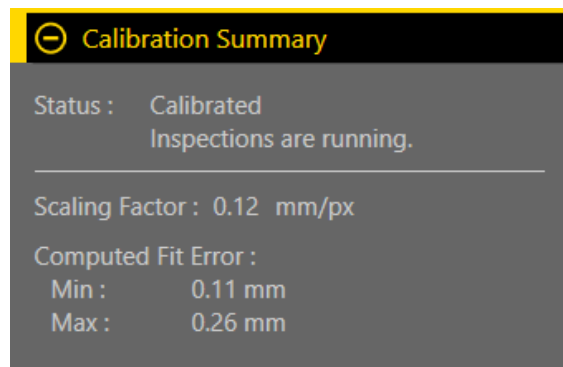

The Computed Fit Error is the distance between a user-defined point in the real world coordinate space and the computed point, based on the fit of all points in the real world coordinate space. Vision Manager displays the minimum and maximum computed fit errors for all user-defined points when five or more points are used. If only four points are used, there is no Computed Fit Error.

The **Inputs** parameters pane for the **Camera** tool (on the **Sensor** tab) now includes a **Calibration** dropdown.

Figure 61. Perspective Correction **Calibration** Parameter

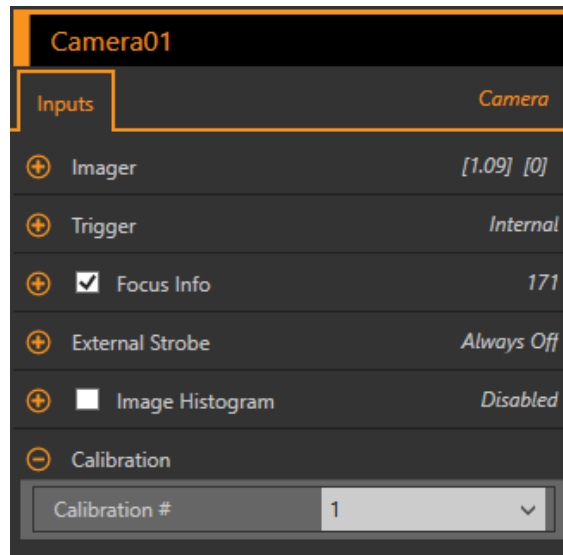

8. If needed, select and add additional Perspective Correction Calibrations from the **Calibration** list at the top right of the screen.
9. Select the desired Perspective Correction calibration for your inspection from the **Calibration** parameter list on the **Inputs** parameters pane for the **Camera** tool.
Only one Perspective Correction Calibration can be associated with each inspection.

Precision

Use **Precision** to set the number of decimal places shown and exported.

Navigate: **System Settings > Units > Precision**.

Figure 62. Precision

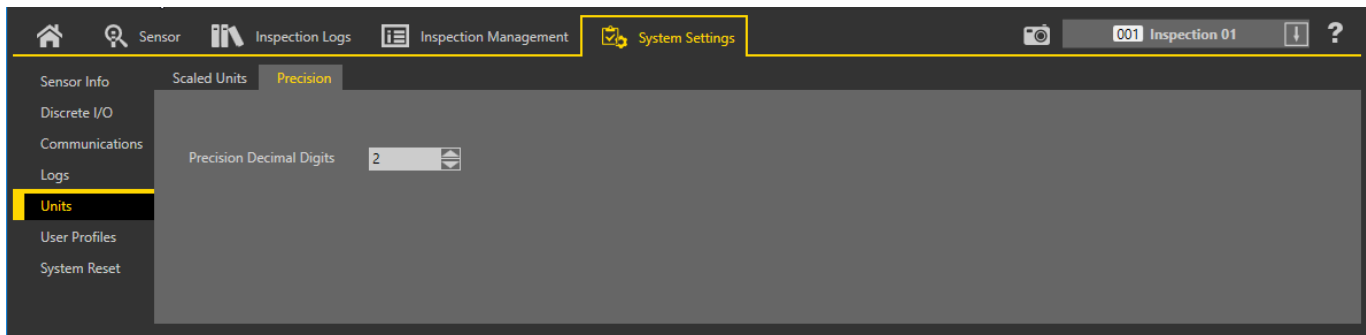

Select the desired number of decimal places, from 1 to 6, that display throughout the software and in exported data. In general, the number of decimal places chosen is the number used, however, there are a few exceptions. See the following descriptions:

Floating Point Representation

All input values represented as decimals are single 32-bit floating point values. The precision varies based on the range; the bigger the floating number, the less precision it may have. As a result, the values entered manually may be automatically adjusted to the closest floating point value.

For example, if the precision is set at 6 decimal digits and the number 123.456789 is entered, this is not a valid floating point number. However the closest floating point number is 123.456787109375, so the value is approximated to 123.456787.

Camera Exposure

Camera exposure time is restricted by the minimum change the imager can perform. As a result, the values entered manually may be automatically adjusted to the next value accepted by the imager.

Imager exposure precision:

- WVGA: 14 μ s
- 1.3 MP: 14 μ s
- 2 MP: 15 μ s
- 5 MP: 10 μ s

External Strobe

The external strobe duration and the external strobe exposure delay are restricted to 1 μ s resolution. As a result, the values entered by the user may be automatically adjusted to the next μ s value.

6.5.6 User Profiles

Use **User Profiles** to prevent users from accessing specific features or making changes to the system. When User Profiles is enabled users are required to enter a user name and password to access the sensor. Users cannot access the system without a valid login.

User Profiles are specific to each sensor. Enable User Profiles on each sensor that requires extra security.

Note that when User Profiles are enabled, the sensor display is available as read-only. No editing can be done directly from the sensor until User Profiles are disabled for that sensor.

Users

Use the **Users** tab to manage the use of user names and passwords and to view or change the type of user, user name, and password for each user. Passwords are not required.

Navigate: **System Settings** > **User Profiles** > **Users**.

Figure 63. Users Tab

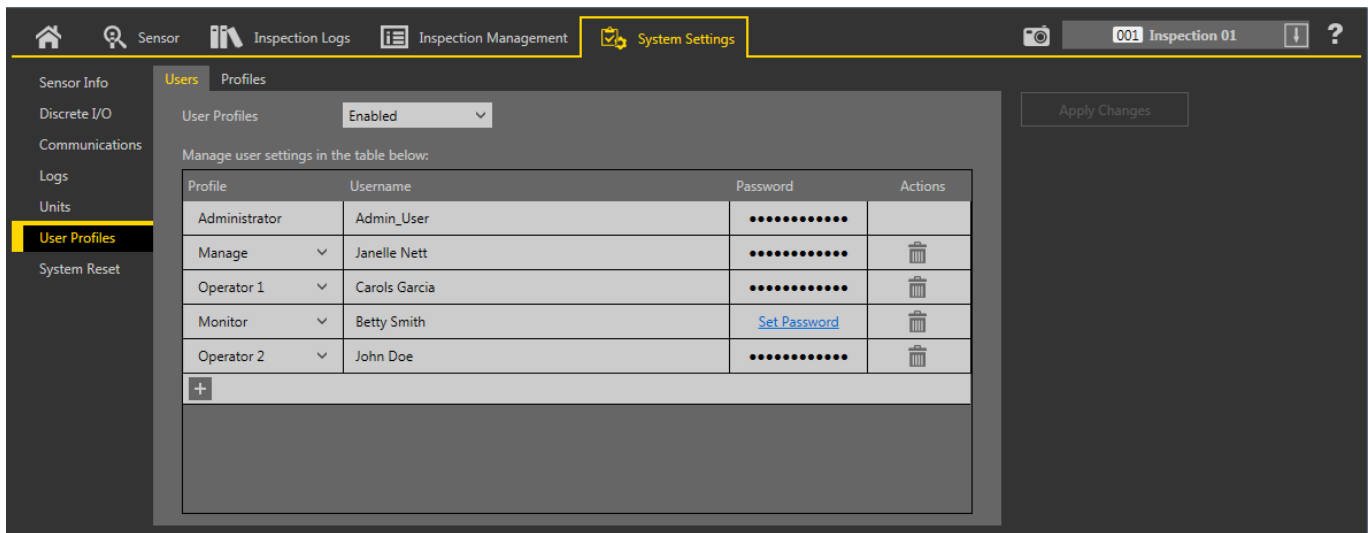

User Profiles are disabled by default. To enable User Profiles, select **Enabled** from the **User Profiles** list. This enables User Profiles for the sensor you are currently connect to. The next time you connect to the sensor, you must enter a user name and password to access the sensor, inspections, and other information.

Add a User

Use this procedure to add a new user to the system. Only an Administrator can add new users.

1. Click . A new user is added and the **Username** field is active.
2. Enter the user name in the **Username** field.



Note: Use only letters, numbers, spaces, and the underscore in your user name.

3. Click **Set Password** to add a password, if desired. The **Change Password** screen displays.

4. Enter and confirm the desired password.
5. Click **Continue**.
6. Select the type of user from the **Profile** list.

The type of user determines the level of access the user has. The level of access can be changed from the **Profiles** tab. See [Profiles](#) on p. 55.

7. Click **Apply Changes**.

Change a Password

Use this procedure to change a password. Users can change their own password. An Administrator can change any password.



Note: If you are a non-Administrator user and you lose your password, an Administrator can change your password to a new one. If you are an Administrator and you lose your password, contact Banner Engineering.

1. Click **System Settings > User Profiles**.
An Administrator sees all available user names. Any other user sees only their own name.
2. Click inside the Password field next to the desired user.
The **Change Password** window displays.
3. Enter and confirm the new password, then click **Continue**.
4. Click **Apply Changes**.

Change a User Name

Use this procedure to change a user name. Only an Administrator can change a user name.

1. Click **System Settings > User Profiles**.
2. Click inside the **Username** field for the desired user.
The field becomes active.
3. Enter the desired user name.
4. Click **Apply Changes**.

Profiles

Use the **Profiles** tab to determine the level of access given to each type of user (user profile).

Navigate: **System Settings > User Profiles > Profiles**.

Figure 64. Profiles Tab

Feature	Administrator	Manage	Operator 1	Operator 2	Monitor
Display					
Monitor view only					<input checked="" type="checkbox"/>
Operation					
Product change	<input checked="" type="checkbox"/>	<input checked="" type="checkbox"/>	<input checked="" type="checkbox"/>	<input checked="" type="checkbox"/>	<input type="checkbox"/>
Manual trigger	<input checked="" type="checkbox"/>	<input checked="" type="checkbox"/>	<input checked="" type="checkbox"/>	<input type="checkbox"/>	<input type="checkbox"/>
Reset pass/fail counts	<input checked="" type="checkbox"/>	<input checked="" type="checkbox"/>	<input checked="" type="checkbox"/>	<input type="checkbox"/>	<input type="checkbox"/>
Clear system error	<input checked="" type="checkbox"/>	<input checked="" type="checkbox"/>	<input type="checkbox"/>	<input type="checkbox"/>	<input type="checkbox"/>
Inspection					
Add/copy/delete inspections	<input checked="" type="checkbox"/>	<input checked="" type="checkbox"/>	<input type="checkbox"/>	<input type="checkbox"/>	<input type="checkbox"/>
Modify inspections	<input checked="" type="checkbox"/>	<input checked="" type="checkbox"/>	<input type="checkbox"/>	<input type="checkbox"/>	<input type="checkbox"/>
Transfer inspections out	<input checked="" type="checkbox"/>	<input checked="" type="checkbox"/>	<input checked="" type="checkbox"/>	<input type="checkbox"/>	<input type="checkbox"/>

The **Profiles** tab shows the functions that are enabled or disabled for each user profile. Only an Administrator can change the functions or the profile names. Select and clear the check boxes to enable or disable the desired functions for each user profile. The selected functions apply to every user of that user profile. Click to return this screen to the default functions for each user profile.

When an unauthorized user attempts to access a restricted feature, a warning displays that the user is not authorized. In many cases, a  displays next to items in the software to indicate that the item is not available for the current user. An Administrator user has all available functions, and this column is not editable. Using the default selections, a Monitor user has the fewest available functions.

6.5.7 System Reset

Use **System Reset** to reboot the sensor or to restore the sensor to the factory default settings.

Click **Reboot Sensor** to stop, shutdown, and restart the sensor. The start-up inspection is loaded after the sensor reboot.

Click **Reset to Factory Defaults** to restore the sensor to the factory default settings.



Important: All stored inspections are deleted when factory default settings are restored. All user profile information (user names and passwords) is deleted when factory default settings are restored. Ethernet settings and favorites lists are retained.

7 Using the Camera Tool

The camera tool controls the sensor's camera function during an inspection. Configure the camera tool using the parameters in the **Parameters** pane:

- Imager
- Focus Info
- Trigger
- External Strobe
- Image Histogram

Figure 65. Camera Tool Input Parameters

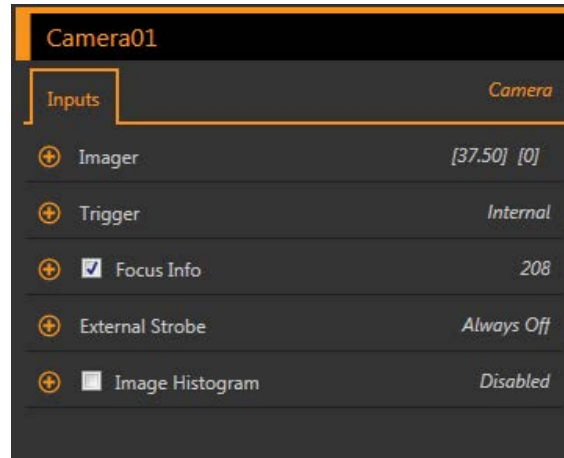

When the camera tool is selected, it is highlighted orange in **Tools & Results** and in **Tools Only**, the **Inputs** tab displays on the **Parameters** pane, and the camera tool results are highlighted in **All Results**.

7.1 Imager

Use the **Imager** parameters to adjust the exposure and gain.

Figure 66. Imager

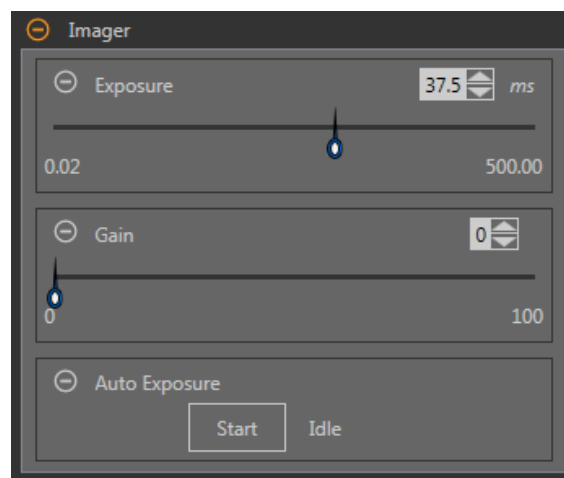

Exposure

Exposure time is the amount of time the camera allows light to energize the imager chip. Increasing the exposure time allows more light to energize the imager chip, which brightens the picture. Use the slider or enter the desired exposure time in milliseconds.

Gain

Gain is an electronic boost to the image signal. Increasing gain increases image brightness without increasing exposure time. Use the slider or enter the desired gain number.



Note: Gain brightens both the light pixels and the dark pixels. High gain values will make the image appear grainy.

Auto Exposure

During Auto Exposure, the exposure time and gain are optimized for the current inspection. Click **Start** to begin Auto Exposure.



Note: Several triggers may be required to calculate the optimized values for exposure and gain.

7.2 Trigger

Use the **Trigger** parameters to set the method and rate at which the sensor captures images. Trigger parameters are stored in the inspection file and can be different for each inspection.

Figure 67. Trigger

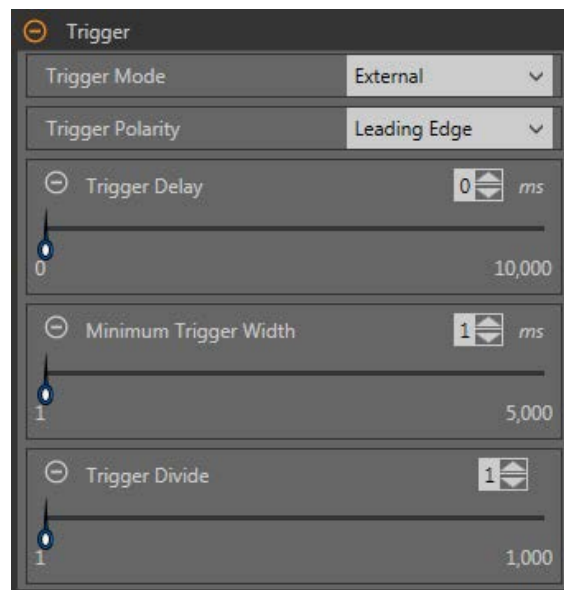

Internal (default)

The sensor triggers itself at a user-defined rate. Use the slider or enter the desired rate, from 10 ms to 10,000 ms. The default rate is 100 ms.

External

The sensor is triggered either manually using the trigger button  in the Vision Manager software or it is triggered by an external source (via the trigger pin), such as a photoelectric sensor. The external trigger option has the following parameters:

- **Trigger Polarity**—Sets when the image is captured compared to the trigger signal. Choose **Leading Edge** to capture images at the leading edge of a trigger signal. Choose **Trailing Edge** to capture images at the trailing edge of the trigger signal. The default is **Leading Edge**.
- **Trigger Delay**—Sets the fixed time from the instant the sensor receives a valid trigger to the instant the sensor captures the image. Use the slider or enter the desired time in milliseconds, from 0 ms to 10,000 ms. The default is 0 ms.
- **Minimum Trigger Width**—Eliminates unwanted triggers by accepting triggers only if they last for a specified duration. Use the slider or enter the desired minimum trigger width in milliseconds, from 1 ms to 5,000 ms. The default is 1 ms.
- **Trigger Divide**—Sets the logic for how valid trigger inputs are related to actual images taken. If the Trigger Divide is set to 1, an image is captured in response to every valid trigger. If it is set to 2, an image is captured in response to every second valid trigger, and so on. Use the slider or enter the desired trigger divide, from 1 to 1,000. The default is 1.

Free Run

The sensor immediately issues a new trigger at the end of an inspection.

Industrial Ethernet

The Industrial Ethernet communications channel controls the trigger. A PLC or HMI triggers the camera tool over an Industrial Ethernet protocol such as EtherNet/IP or PROFINET.

7.3 Focus Information

Select the **Focus Info** checkbox and expand the parameter to view the current focus number for the installed lens.

Figure 68. Focus Info

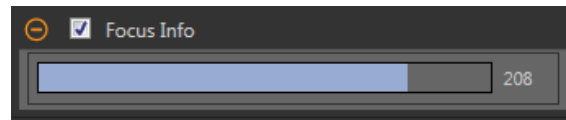

The focus number is a number between 1 and 255. Use the **Image** pane to determine when the image is sharp enough, or use the focus number as a guide. Turn the focus ring on the lens until the focus number is at the highest possible number between 1 and 255. The focus number is also available on the sensor display.



Note: There is no optimal value for this number, but it can be used as a guide if you are setting up more than one sensor that are focused on the same target.

7.4 External Strobe

Use **External Strobe** to control an external light connected to the sensor.

Figure 69. External Strobe

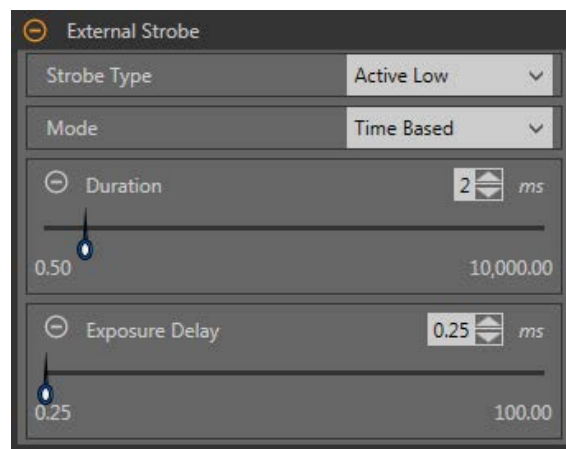

Strobe Type

The strobe type of the VE Series camera should match the style of external light used, otherwise the ON/OFF behavior of the light will be inverted.

- **Active Low**—A 0 V dc external strobe signal is provided by the VE Series camera when the external light should be ON. A +5 V dc external strobe signal is provided by the VE Series camera when the external light should be OFF. This is the default strobe type setting for the VE Series camera and many of the external vision lights Banner offers.
- **Active High**—A +5 V dc external strobe signal is provided by the VE Series camera when the external light should be ON. A 0 V dc external strobe signal is provided by the VE Series camera when the external light should be OFF.

Mode

- **Always Off**—The external light is always OFF
- **Always On**—The external light is always ON
- **Exposure Based**—The external light is ON for the duration of the camera exposure time
- **Time Based**—The external light is ON for the duration of a user-defined time period

Exposure Delay

The external light turns ON after a user-defined time delay, in milliseconds, after a valid trigger. Available only when the Mode is Exposure Based or Time Based.

Duration

The external light is ON for a user-defined amount of time, in milliseconds. Available only when the Mode is Time Based.

7.5 Camera Tool: Results

Click the camera tool on **Tools & Results** or expand the camera tool on **All Results** to view camera information.

Figure 70. Camera Tool Results

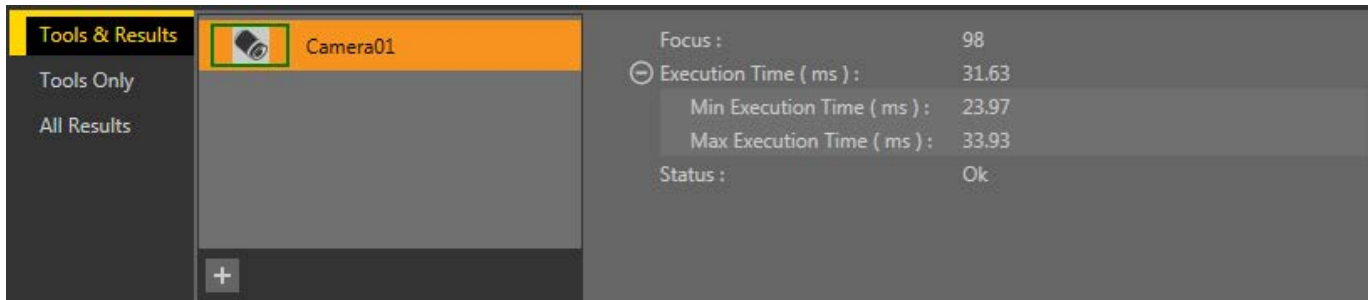

Focus Number

The focus number for the frame being viewed, if the Focus Number parameter is enabled in the Camera tool. See [Focus Information](#) on p. 59 for more information on the Focus Number.

Execution Time

The execution time for the camera tool. This is the total time required to capture an image.

Expand **Execution Time** to see the historical minimum and maximum execution times up to this point for the selected tool.

Status

Status and error messages display as appropriate.

8 Using the Inspection Tools: Vision Tools

Vision sensor tools include Average Gray, Bead, Blemish, Blob, Edge, Locate, Match, and Object.

Click a tool on **Tools & Results** or on **Tools Only** to access the **Parameters** pane for that tool. The **Parameters** pane contains both an **Inputs** tab and a **Test** tab. Define parameters for the tool itself on the **Inputs** tab. Define pass or fail criteria for the tool on the **Test** tab. When a tool is selected, the tool is highlighted orange in **Tools & Results** and in **Tools Only**, the tool ROI is selected in the **Image** pane, and the tool results are highlighted in **All Results**.

For many of the parameters, move the slider to set the desired number, or move both sliders to set minimum and maximum limits, where applicable. Numbers and limits can also be entered manually.

In parameters with colors in the sliders, vertical green bars represent current image information. Light gray backgrounds indicate the range over which a value has varied over time.

8.1 Average Gray Tool

Use the Average Gray tool to determine the brightness levels of pixels found within the ROI.

Each pixel has a grayscale intensity value from 0 to 255, where 0 is black and 255 is white. The tool records the grayscale value of each pixel in an ROI and averages them. With this information, the tool can detect changes in intensity that can indicate several conditions, such as missing objects, holes, texture changes, and possible color changes.

Example applications:

- Spot-check for holes
- Check for a change in surface texture
- Check for presence/absence of a label or other objects

8.1.1 Average Gray Tool: Input Parameters

Use the **Input** parameters to configure how the tool analyzes an image.

Figure 71. Average Gray Tool—Input Parameters

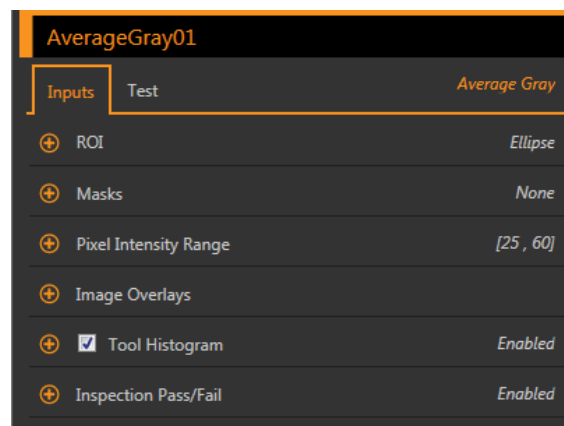



ROI

The Region of Interest (ROI) is the user-defined group of pixels in the image that the sensor analyzes.

Figure 72. ROI Shape Selection



Resize  and rotate  the ROI around the feature to be analyzed. Change the shape of the ROI to a square, ellipse, or circle as needed by expanding **ROI** on the **Parameters** pane and selecting the desired shape. An ROI can be as large as the entire Field of View (FOV). The ROI automatically displays on the **Image** pane when a tool is added.

Adjust the placement of the ROI more precisely by using the arrow keys on the computer keyboard.

Masks

Add and define a mask to exclude a group of pixels from the tool analysis.

Figure 73. Masks Parameters

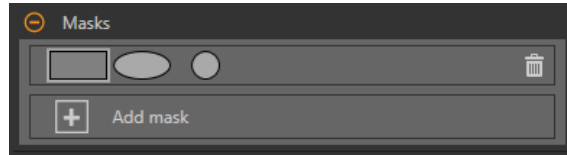

A mask created for a tool will not apply to any other tool in the inspection. Up to 10 masks can be added to a tool.

1. Expand **Masks** on the **Inputs** tab.
2. Click . The mask ROI automatically displays on the **Image** pane.
3. Select the mask shape. The mask ROI can be rectangular, elliptical, or circular.
4. Resize and rotate the mask ROI around the pixels to be excluded.
5. To delete a mask, click .

Pixel Intensity Range

Set the intensity range of pixels to analyze. Pixels with brightness values outside of this range are ignored.

Figure 74. Pixel Intensity Range Parameters

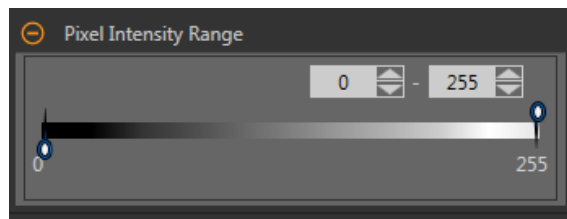

The default settings of 0 to 255 allow all pixels to be included in the average calculation.



Note: An average grayscale result of – indicates that all pixels in the ROI have been excluded by the pixel intensity range parameter.

Image Overlays

Choose whether to display or hide the ROI or masks.

Figure 75. Image Overlays—Default

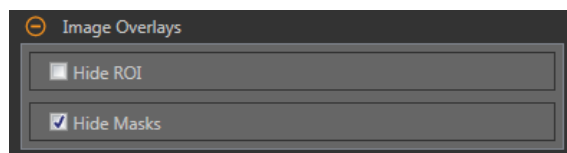

These options override the ROI view buttons on the Image Pane Parameters when no tool is selected. When a specific tool is selected, the ROI information is shown.

Hide ROI

Hides the ROI when the tool is **not** selected.

Hide Masks

Hides the Mask ROI when the tool is **not** selected.

Tool Histogram

The Tool Histogram graphically displays pixel intensity information within the current ROI.

Figure 76. Example Histogram

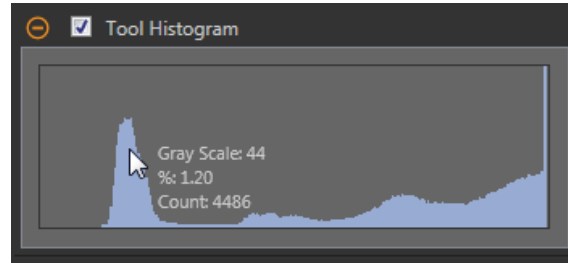

Select the **Tool Histogram** checkbox to enable the histogram. The default is enabled. Expand the **Tool Histogram** parameter to view the histogram.

The histogram is a display of the grayscale values on the x axis and the number of pixels on the y axis. The histogram displays the amount of pixels for each grayscale value. The graph displays information for all grayscale values (0 to 255). Move the pointer anywhere over the histogram to view specific information. The information updates as the position of the pointer changes.

Inspection Pass/Fail

Select the **Contribute to Inspection Pass/Fail** check box (default) if the tool will influence the Pass/Fail status of the inspection.

Figure 77. Inspection Pass/Fail

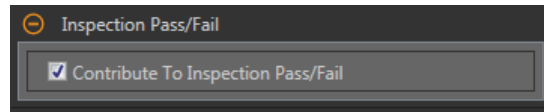

The Pass/Fail contribution influences the following:

- Discrete output Pass
- Discrete output Fail
- Pass/Fail results counter
- Pass (Green) and Fail (red) LEDs on the Sensor

Select this checkbox if the overall Pass/Fail status of the inspection is dependent on the current tool.

8.1.2 Average Gray Tool: Test Parameters

Use the **Test** parameters to configure the pass/fail conditions for the tool.

Select the parameter checkbox to enable it. Where applicable, the vertical green bar shows the current parameter information and the light gray backgrounds show the range over which a value has varied over time.

Where applicable, use the sliders or enter the minimum and maximum for the selected test parameters.

The current data found and the range of historical data found are shown for applicable **Test** parameters. The historical data begins from the last reset.

Figure 78. Average Gray Tool—Test Parameters



Average Grayscale

The grayscale value range.

Standard Deviation

The standard deviation range.

8.1.3 Average Gray Tool: Results

Tools & Results and **All Results** list information from the current and previous inspections.

A red box around a tool indicates that the tool failed. **Status** provides information about the specific failure.

All Results displays the Result, Time, Pass Count, and Fail Count information at a glance. Expand the inspection tool to see specific results for that tool.

Average Grayscale

The average grayscale value of the pixels in the ROI.

Standard Deviation

The standard deviation of the average grayscale value for the pixels in the ROI.

Execution Time

The execution time, in milliseconds, for the currently selected tool in the current inspection.

Expand **Execution Time** to see the historical minimum and maximum execution times up to this point for the selected tool.

Use the reset button in the Inspection Summary to reset these historical values.

Status

Status and error messages display as appropriate.

8.1.4 Using the Average Gray Tool

Follow these steps for a typical presence/absence Average Gray inspection.



Note: This procedure is an example only.

1. Add an Average Gray tool to the inspection.
2. Adjust the ROI to frame the desired feature.
3. Set the **Test** parameters to set the pass/fail criteria.
 - a) On the **Test** tab, select the **Average Grayscale** checkbox.

This option sets the grayscale range that must be present in the ROI so that a part passes.
 - b) Move the sliders or enter the minimum and maximum grayscale. Inspections outside of this range will fail. For this example, the minimum is 56.12 and the maximum is 74.83.

The green bar indicates the current grayscale and the light gray background indicates the grayscale over time since the last reset.
4. Test a complete range of good and bad samples to make sure that the sensor accepts good parts and rejects bad parts.

Figure 79. Average Gray—Pass

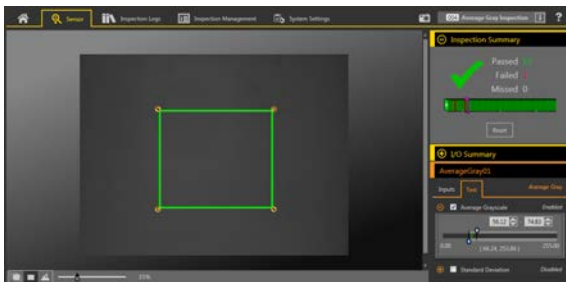
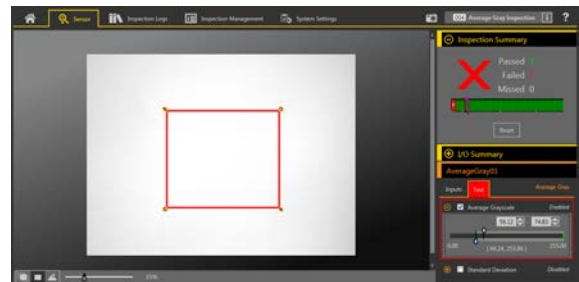

Figure 80. Average Gray—Fail



8.2 Bead Tool

Use the Bead tool to inspect parts for uniformity of adhesive or sealant material, or for uniformity of a gap. In an industrial setting, this "bead" of material is commonly applied in a strip along a known path. The Bead tool looks at this pre-defined path and verifies whether the adhesive or sealant has been correctly applied.

For the purposes of this tool, a bead is any long, narrow strip of approximately consistent width and approximately consistent color. The bead must have sufficient contrast with the background so that a simple grayscale threshold scheme can separate the two. Background clutter and optical noise, such as shiny spots or holes in the bead, are permitted, but their presence may degrade the robustness of a bead inspection.

The Bead tool assumes that the bead material has been applied by a mechanized system and is consistent in location and direction. The tool does not attempt to detect, follow, or account for variations in bead location.

Example applications:

- Detect uniformity of a bead of adhesive
- Detect uniformity of a gap between two adjacent materials

8.2.1 Bead Tool: Input Parameters

Use the **Input** parameters to configure how the tool analyzes an image.

Figure 81. Bead Tool—Input Parameters

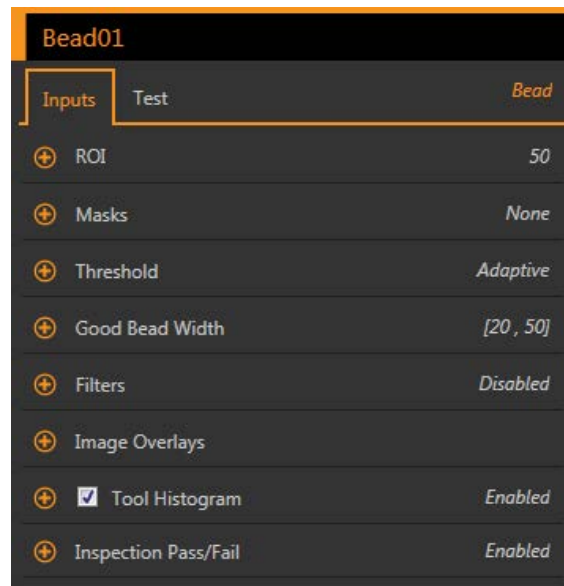

ROI

The Region of Interest (ROI) is the user-defined group of pixels in the image that the sensor analyzes.

Figure 82. Bead Tool ROI

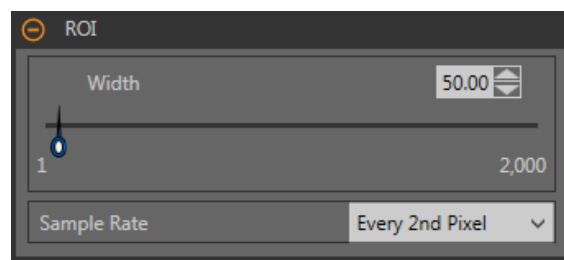

The ROI is configurable to follow the desired path of the adhesive or sealant being analyzed. Adjust the width of the ROI and set the sample rate. From the list select the frequency of bead width measurements: Every Pixel, Every 2nd Pixel, or Every 4th Pixel. See [Bead Tool: Adjust the ROI](#) on p. 71.

Adjust the placement of the ROI more precisely by using the arrow keys on the computer keyboard.



Masks

Add and define a mask to exclude a group of pixels from the tool analysis.

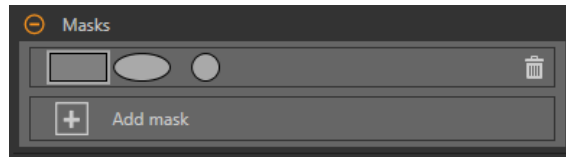
Figure 83. Masks Parameters



A mask created for a tool will not apply to any other tool in the inspection. Up to 10 masks can be added to a tool.

1. Expand **Masks** on the **Inputs** tab.
2. Click **+**. The mask ROI automatically displays on the **Image** pane.
3. Select the mask shape. The mask ROI can be rectangular, elliptical, or circular.
4. Resize  and rotate  the mask ROI around the pixels to be excluded.
5. To delete a mask, click .

Threshold

The threshold parameter separates the bead from the background, in terms of contrast.

Threshold Type: Adaptive

Select Adaptive when there are lighting changes that cause the acquired image to change.

Figure 84. Threshold Type—Adaptive

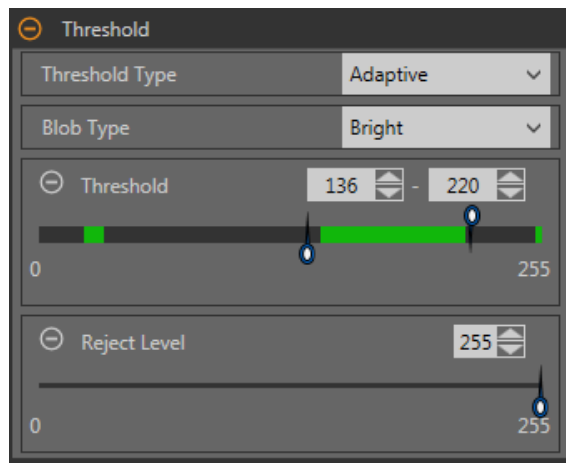

An adaptive threshold is a technique that adjusts the threshold for the tool based upon lighting changes and image content within the ROI. It performs best if used with bi-modal images, which have a clear contrast in the ROI. Adaptive threshold chooses the current threshold value by converging to a value based on the average value of the pixels above and below the previous threshold value; it will not move the value of the threshold above or below the minimum and maximum limits.

Adaptive Threshold: Bead/Blob Type

Defines whether the bead/blob is dark against a relatively brighter background or bright against a darker background.

This parameter defines the appearance of the feature of interest. For example, if you have a dark adhesive or part on a bright background, choose **Dark**.

Choosing **Dark** with an adaptive threshold type causes the tool to limit the threshold to the range specified by the threshold level minimum and maximum limits. The tool identifies all grouped pixels below the threshold chosen as dark beads/blobs.

Choosing **Bright** with an adaptive threshold type causes the tool to limit the threshold to the range specified by the threshold level minimum and maximum limits. The tool identifies all grouped pixels above the specified minimum limit and less than or equal to the maximum limit as bright beads/blobs.

Adaptive Threshold: Threshold

Use the sliders or enter the desired minimum and maximum possible grayscale threshold.

The green line is the current threshold value, chosen by the tool, and the sliders represent boundaries beyond which you do not want the tool to move the threshold settings.

Reject Level

When the Bead/Blob Type is set to Bright, use the **Reject Level** to narrow the range of pixel intensities to be considered in an inspection.

Leaving the defaults at 0 for low and 255 for high means that the tool takes into consideration all grayscale levels in the ROI from 0 (black) to 255 (white).

Reject Level Example

Consider setting up an inspection for a relatively bright object that ranges from 180 to 200 in pixel intensity and takes up 15 percent of the FOV. The remaining 85 percent of the FOV ranges from 230 to 255 in pixel intensity. Setting a Reject Level of 220 allows the tool to pay attention to only the bright object being inspected. Masking the bright parts of the FOV is not necessary because only pixels whose intensity is less than the Reject Level will contribute to bright beads/blobs.

Threshold Type: Fixed

Select **Fixed** when the lighting and image content remain relatively constant for all inspections.

Figure 85. Threshold Type—Fixed

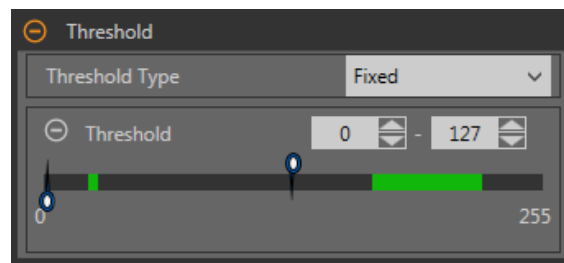

Fixed Threshold: Bead/Blob Type

Defines whether the bead/blob is dark against a relatively brighter background or bright against a darker background.

This parameter defines the appearance of the feature of interest. For example, if you have a dark adhesive or part on a bright background, choose **Dark**.

Choosing **Dark** with a fixed threshold type causes the tool to fix the threshold at the level specified by the Threshold level parameter. The tool identifies all grouped pixels below the specified threshold as dark beads/blobs.

Choosing **Bright** with a fixed threshold type causes the tool to fix the threshold at the Bright level specified by the Threshold level parameter. The tool identifies all grouped pixels above the specified Bright threshold and less than or equal to the Reject level as bright beads/blobs.

Fixed Threshold: Threshold

Use the slider to define the dark/bright cutoff point.

Any pixels brighter than this point define the bright bead while those darker than this point define the dark bead.

Reject Level

When the Bead/Blob Type is set to Bright, use the **Reject Level** to narrow the range of pixel intensities to be considered in an inspection.

Leaving the defaults at 0 for low and 255 for high means that the tool takes into consideration all grayscale levels in the ROI from 0 (black) to 255 (white).

Reject Level Example

Consider setting up an inspection for a relatively bright object that ranges from 180 to 200 in pixel intensity and takes up 15 percent of the FOV. The remaining 85 percent of the FOV ranges from 230 to 255 in pixel intensity. Setting a Reject Level of 220 allows the tool to pay attention to only the bright object being inspected. Masking the bright parts of the FOV is not necessary because only pixels whose intensity is less than the Reject Level will contribute to bright beads/blobs.

Good Bead Width

Move the sliders or enter the desired minimum and maximum bead width.

The red section is bead that is too narrow or is a gap. The green section is good bead width. The blue section is bead that is too wide.

Figure 86. Good Bead Width

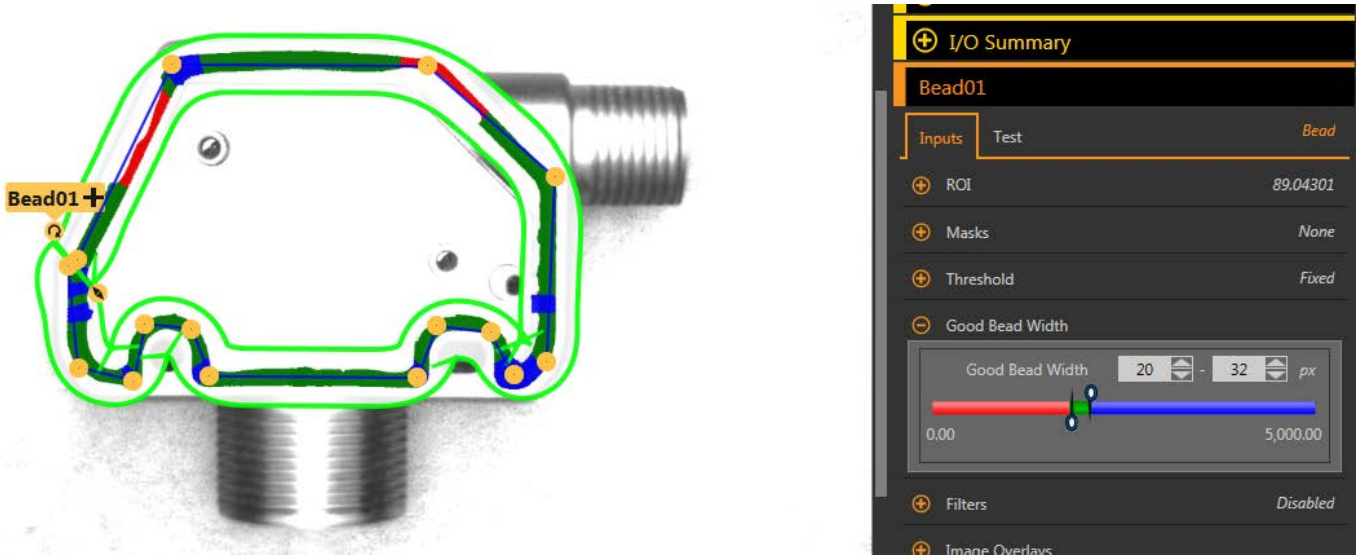

Filters

Select the checkbox to ignore boundary pixels.

Figure 87. Bead Tool Filters

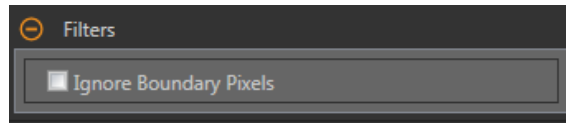



Boundary pixels are bead pixels that touch the ROI. If boundary pixels are ignored, one or more segments may also be ignored.

Image Overlays

Choose whether to display or hide the annotations, ROI, or masks when this tool is **not** selected. Masks are hidden by default.

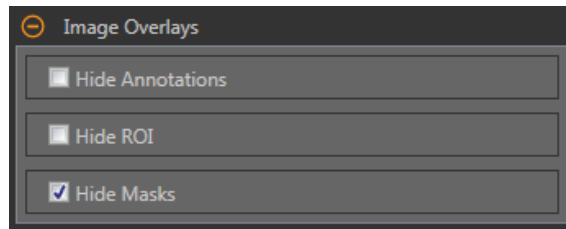
Figure 88. Image Overlays—Default



These options override the ROI view buttons  on the Image Pane Parameters when no tool is selected. When a specific tool is selected, the ROI information is shown.

Hide Annotations

Hides the annotations on the live image for the tool, even when the tool is selected.

Figure 89. Show Bead Tool Annotations

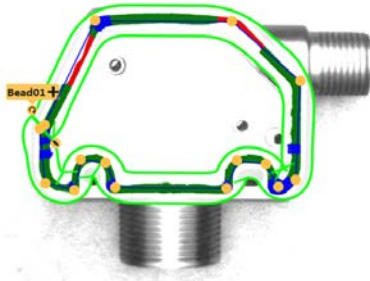
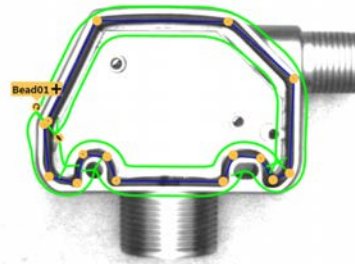

Figure 90. Hide Bead Tool Annotations



Hide ROI

Hides the ROI when the tool is **not** selected.

Hide Masks

Hides the Mask ROI when the tool is **not** selected.

Tool Histogram

The Tool Histogram graphically displays pixel intensity information within the current ROI.

Figure 91. Example Histogram

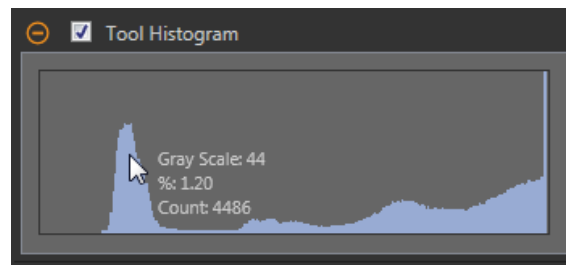

Select the **Tool Histogram** checkbox to enable the histogram. The default is enabled. Expand the **Tool Histogram** parameter to view the histogram.

The histogram is a display of the grayscale values on the x axis and the number of pixels on the y axis. The histogram displays the amount of pixels for each grayscale value. The graph displays information for all grayscale values (0 to 255). Move the pointer anywhere over the histogram to view specific information. The information updates as the position of the pointer changes.

Inspection Pass/Fail

Select the **Contribute to Inspection Pass/Fail** check box (default) if the tool will influence the Pass/Fail status of the inspection.

Figure 92. Inspection Pass/Fail

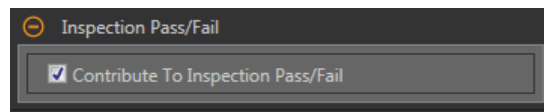

The Pass/Fail contribution influences the following:

- Discrete output Pass
- Discrete output Fail
- Pass/Fail results counter
- Pass (Green) and Fail (red) LEDs on the Sensor

Select this checkbox if the overall Pass/Fail status of the inspection is dependent on the current tool.

8.2.2 Bead Tool: Test Parameters

Use the **Test** parameters to configure the pass/fail conditions for the tool.

Select the parameter checkbox to enable it. Where applicable, the vertical green bar shows the current parameter information and the light gray backgrounds show the range over which a value has varied over time.

Where applicable, use the sliders or enter the minimum and maximum for the selected test parameters.

The current data found and the range of historical data found are shown for applicable **Test** parameters. The historical data begins from the last reset.

Figure 93. Test Parameters

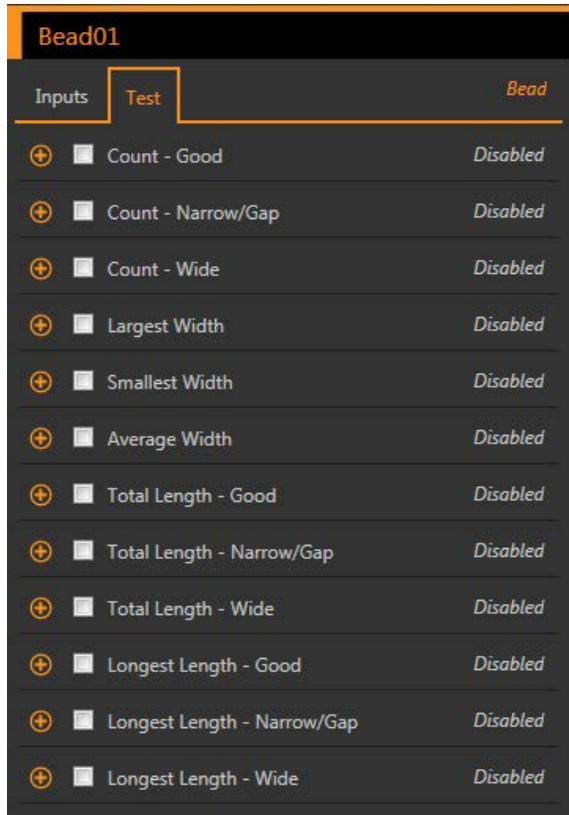

Count - Good

The number of good beads.

Count - Narrow/Gap

The number of narrow beads.

Count - Wide

The number of wide beads.

Largest Width

The maximum width found.

Smallest Width

The minimum width found.

Average Width

The average width found.

Total Length - Good

The total length of good beads.

Total Length - Narrow/Gap

The total length of narrow beads.

Total Length - Wide

The total length of wide beads.

Longest Length - Good

The longest good bead length.

Longest Length - Narrow/Gap

The longest narrow bead length.

Longest Length - Wide

The longest length of wide beads.

8.2.3 Bead Tool: Results

Tools & Results and **All Results** list information from the current and previous inspections.

A red box around a tool indicates that the tool failed. **Status** provides information about the specific failure.

All Results displays the Result, Time, Pass Count, and Fail Count information at a glance. Expand the inspection tool to see specific results for that tool.

Count - Good

The number of beads that fall within the user-defined good bead width.

Expand **Count - Good** to see the length of each bead, the total length of all beads, and the longest length.

Count - Narrow/Gap

The number of narrow beads or gaps that qualify as having a narrow bead width.

Expand **Count - Narrow/Gap** to see the length of each bead, the total length of all beads, and the longest length.

Count - Wide

The number of wide beads that qualify as having a wide bead width.

Expand **Count - Wide** to see the length of each bead, the total length of all beads, and the longest length.

Average Width

The average width of all beads.

Expand **Average Width** to see the largest width and the smallest width.

Adaptive Threshold

The grayscale value used to detect the bead when the Threshold Type is Adaptive. If the tool cannot calculate this value, or if the Threshold Type is Fixed, this value displays as --.

Execution Time

The execution time, in milliseconds, for the currently selected tool in the current inspection.

Expand **Execution Time** to see the historical minimum and maximum execution times up to this point for the selected tool.

Use the reset button in the Inspection Summary to reset these historical values.

Status

Status and error messages display as appropriate.

8.2.4 Bead Tool: Adjust the ROI

Follow these steps to adjust the Bead tool ROI.



Note: This procedure is an example only. Use the appropriate steps to adjust the Bead tool ROI for your application.

1. Add a Bead tool to the inspection.

Figure 94. Add a Bead Tool

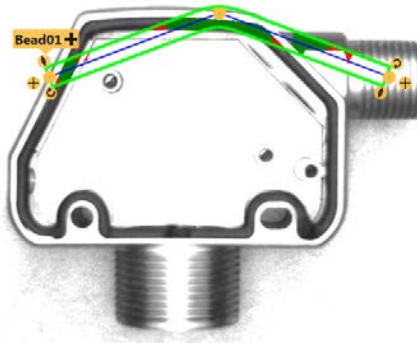

2. Move the ROI over the bead to be inspected.
3. Move an ● anchor point to a new position by clicking on the anchor point when the **Hand** icon displays.

Figure 95. Click to Move Anchor Point

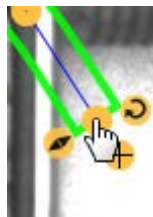

4. Click the + plus sign on either end of the bead ROI to add more anchor points.

Figure 96. Add Anchor Point

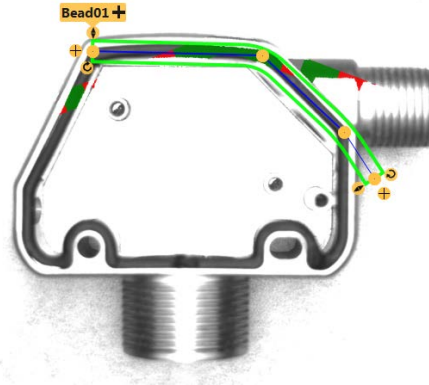

5. Click on a line to add an inline anchor point.
 - a) Point to the ROI line; the pointer changes to a +.

Figure 97. Add Inline Anchor Point

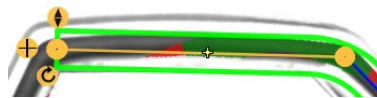

- b) Click to select the location for the new anchor point; + is added on the line.

Figure 98. Inline Anchor Point Location Selected

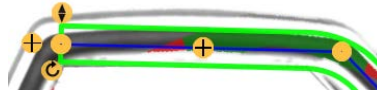

- c) Click the point again to set the location on the line. The + changes to ●.

Figure 99. Inline Anchor Point Set

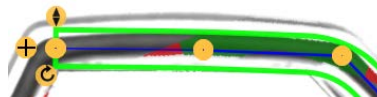



6. Click on an ● anchor point and the  Trash icon displays above it; click the  Trash to delete the point.

Figure 100. Click to Delete Anchor Point



7. Use the ROI sliders in the **Input** tab to change the ROI width.

Figure 101. Bead Tool ROI Width

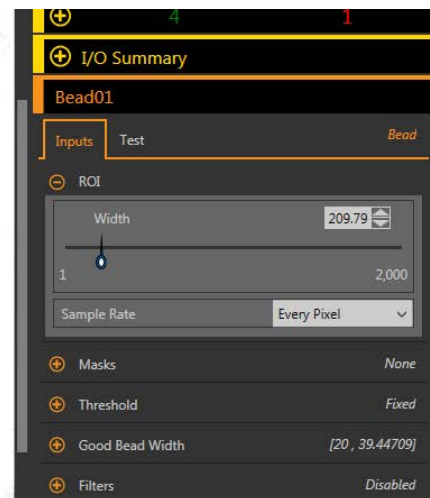
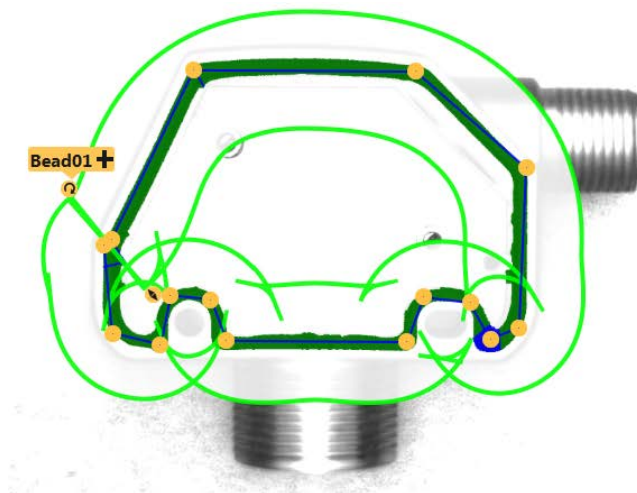

8. Use the **Good Bead Width** parameter under **Characteristics** to define the good bead width. Green indicates that the bead width is acceptable. Red indicates that the bead width is too narrow or that a gap exists. Blue indicates that the bead width is too wide.

Figure 102. Good, Narrow, and Wide Adhesive Widths

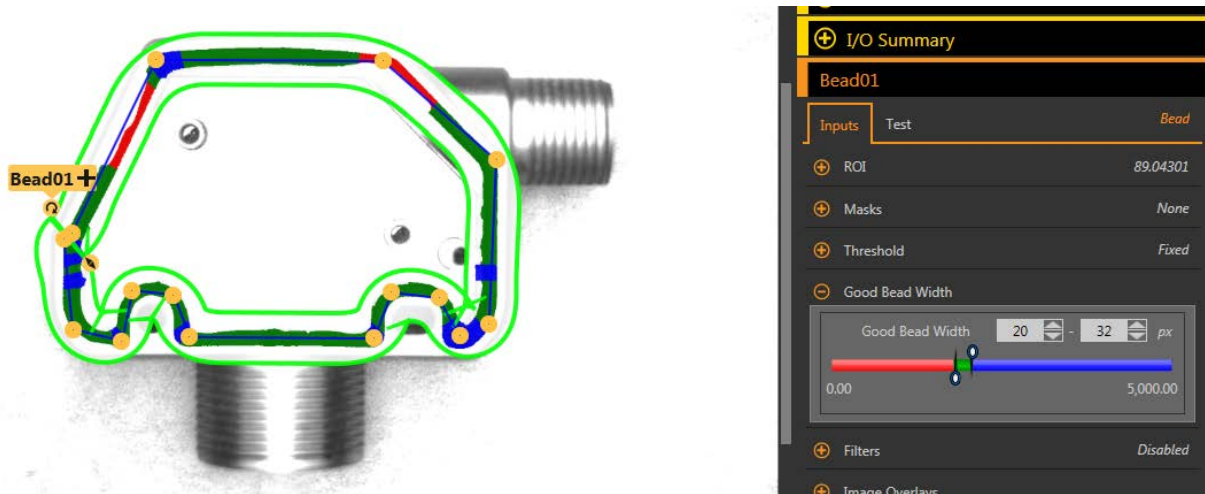

8.2.5 Using the Bead Tool

Follow these steps to configure a Bead tool for a dark adhesive on a bright background.



Note: This procedure is an example only.

In this example, scaling is on (**System Settings > Units > Scaling**) with the Measurement Unit set at Millimeters, the Measurement in Pixels set at 810, and the Measurement in Millimeters set at 70.

1. Add a Bead tool to the inspection.
2. Adjust the ROI path and width to match the adhesive bead.

See [Bead Tool: Adjust the ROI](#) on p. 71.

Figure 103. Bead ROI

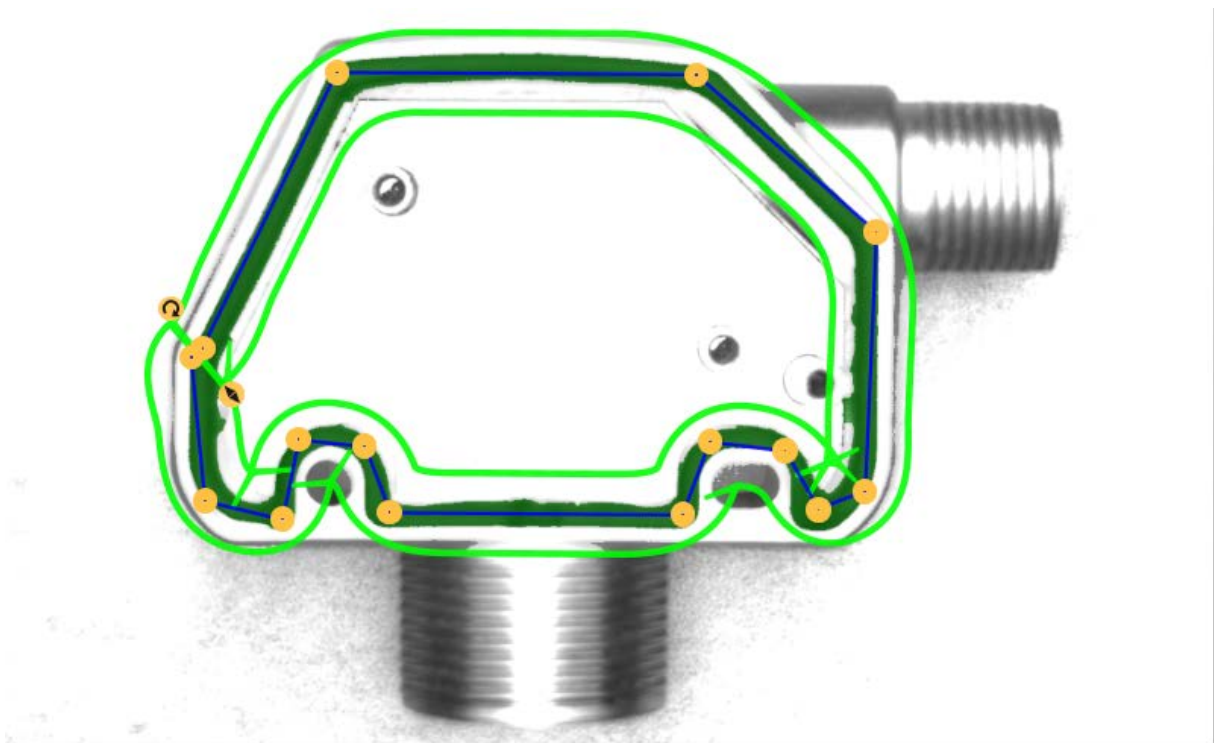

3. Set the threshold.
 - a) Expand the **Threshold** parameters.
 - b) From the **Threshold Type** list, select **Fixed**.
Select Fixed when the lighting and image content remain relatively constant for all inspections.
 - c) From the **Bead Type** list, select **Dark** because in this case the adhesive is dark against a bright background.
 - d) Expand the **Threshold** parameters.
 - e) Move the slider until the adhesive bead shows as green in the ROI and the background is ignored. In this example, that number is 137.

Figure 104. Threshold

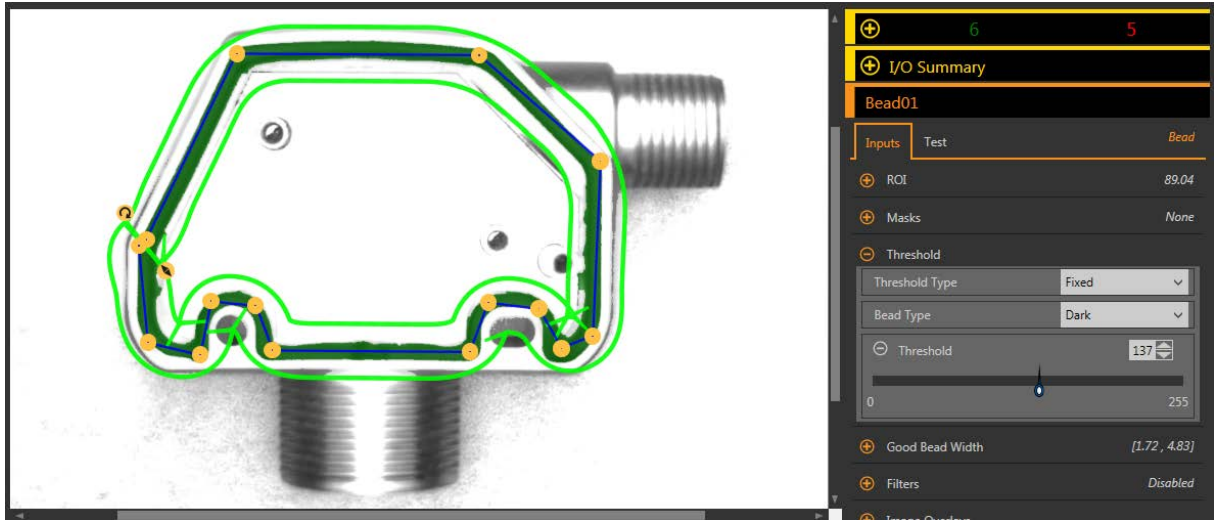

4. Set the bead width.
 - a) Expand the **Good Bead Width** parameter.
 - b) Move the sliders to define the minimum and maximum acceptable bead width. In this example, the minimum bead width is 1.72 mm and the maximum bead width is 4.83 mm.

Figure 105. Good Bead Width

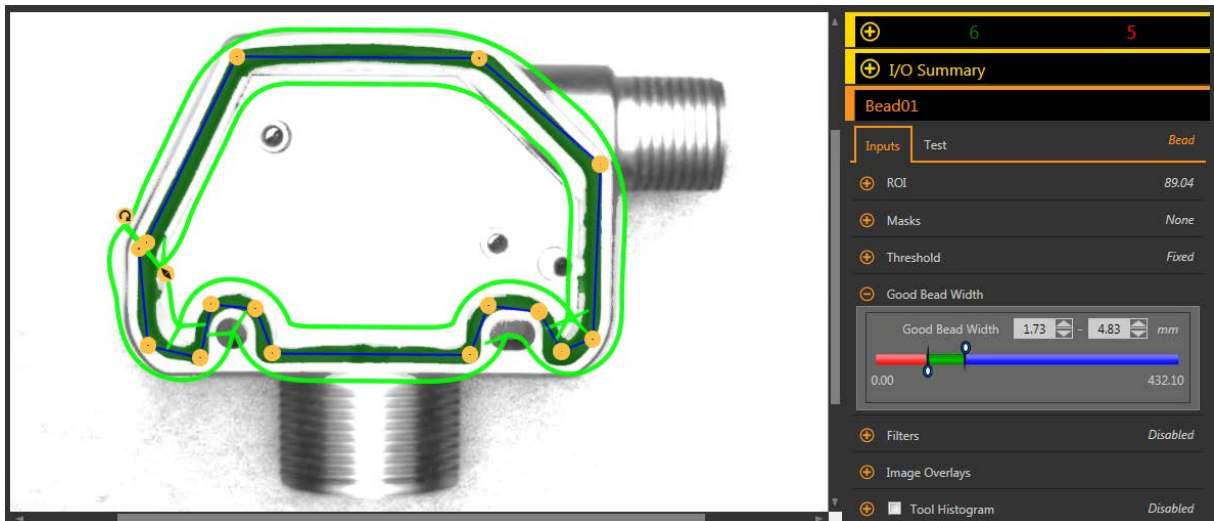

5. Set the test parameters to set the pass/fail criteria.
 - a) On the **Test** tab, select the **Count - Good** checkbox to enable the test parameter.
This option sets the number of good beads that must be present with the tool parameters so that a part passes.
 - b) Expand **Count - Good** and move the sliders or enter the minimum and maximum as 1 and 1.
This means that the inspection must find one and only one bead within the ROI that meets the Good Bead Width definition.
 - c) Select the **Count - Narrow/Gap** checkbox to enable the test parameter.
This option sets the allowable number of gaps in the bead.

- d) Move the sliders or enter the minimum and maximum as 0 and 0.
This means that no gaps are allowed. If gaps are found, the inspection fails.

Figure 106. Test Criteria

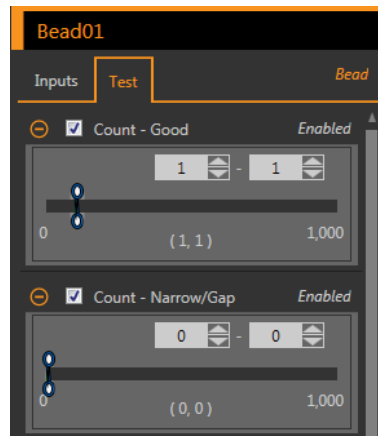

6. Test a complete range of good and bad samples to make sure that the sensor accepts good parts and rejects bad parts.

Figure 107. Bad Part—Narrow Bead Width

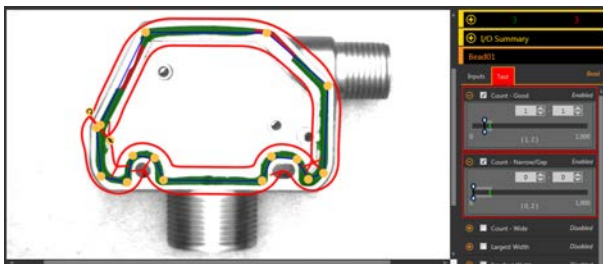
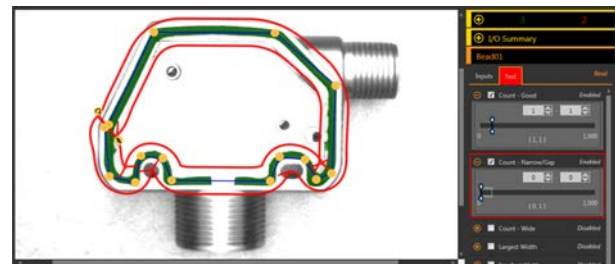

Figure 108. Bad Part—Gap



8.3 Blemish Tool

Use the Blemish tool to determine whether flaws are present on a part (for example, scratches on a disc), or to make sure that a feature exists on a part.

Although finding features is more commonly an application for a Blob tool, the Blemish tool may be a better option to find a feature when dealing with variable materials or inconsistent lighting.

Example applications:

- Check for scratches on a part, and reject parts where the scratches are too numerous or larger than acceptable
- Check for the presence of a label or marking on a part that may vary in brightness level

8.3.1 Blemish Tool: Input Parameters

Use the **Input** parameters to configure how the tool analyzes an image.

Figure 109. Blemish Tool—Input Parameters

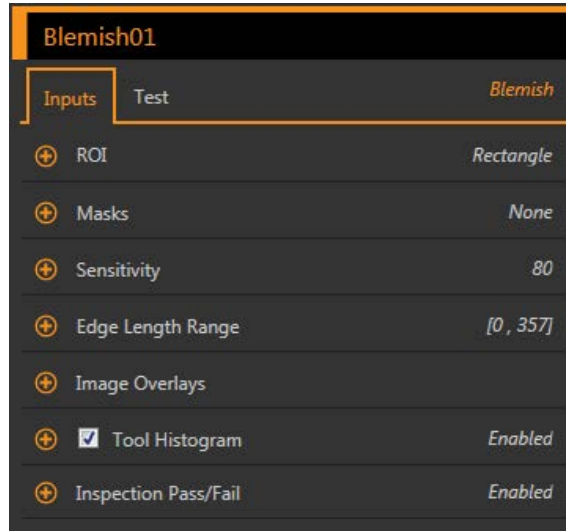



ROI

The Region of Interest (ROI) is the user-defined group of pixels in the image that the sensor analyzes.

Figure 110. ROI Shape Selection



Resize  and rotate  the ROI around the feature to be analyzed. Change the shape of the ROI to a square, ellipse, or circle as needed by expanding **ROI** on the **Parameters** pane and selecting the desired shape. An ROI can be as large as the entire Field of View (FOV). The ROI automatically displays on the **Image** pane when a tool is added.

Adjust the placement of the ROI more precisely by using the arrow keys on the computer keyboard.





Masks

Add and define a mask to exclude a group of pixels from the tool analysis.

Figure 111. Masks Parameters



A mask created for a tool will not apply to any other tool in the inspection. Up to 10 masks can be added to a tool.

1. Expand **Masks** on the **Inputs** tab.
2. Click . The mask ROI automatically displays on the **Image** pane.
3. Select the mask shape. The mask ROI can be rectangular, elliptical, or circular.
4. Resize  and rotate  the mask ROI around the pixels to be excluded.
5. To delete a mask, click .

Sensitivity

Set the **Sensitivity** to define how sensitive the sensor is to finding blemish or other edges within the ROI. The sensitivity value helps account for light variations that can affect how well the sensor detects edges on inspected parts.

Figure 112. Sensitivity

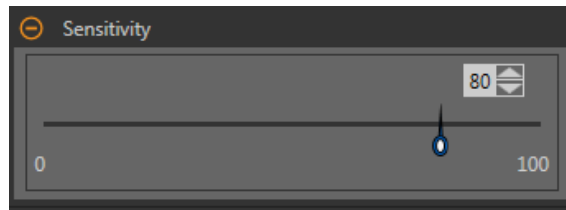

The Sensitivity scale is from 0 to 100 where 0 means least sensitive and 100 means most sensitive. If set near 0, the sensor finds very sharp edges with strong contrast. If set near 100, the sensor finds very dim or blurry edges, and may be unstable. The default is 80.

Edge Length Range

Shows the different contiguous edge segments found.

Figure 113. Edge Length Range

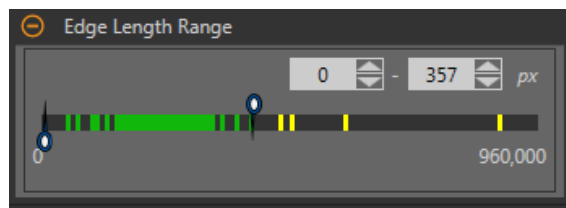



Use the sliders to specify the edge length range in pixels. Edges found within this range will be considered when calculating the Pass Count. Green represents lengths within the specified range and yellow represents lengths outside of the specified range.

Image Overlays

Choose whether to display or hide the annotations, ROI, or masks when this tool is **not** selected. Masks are hidden by default.

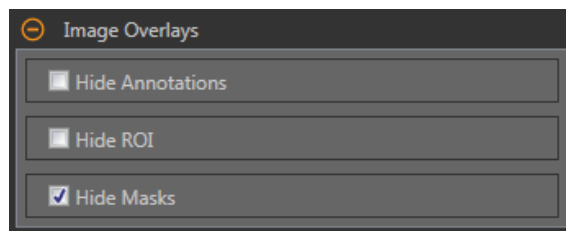
Figure 114. Image Overlays—Default



These options override the ROI view buttons  on the Image Pane Parameters when no tool is selected. When a specific tool is selected, the ROI information is shown.

Hide Annotations

Hides the annotations on the live image for the tool, even when the tool is selected.

Figure 115. Show Blemish Tool Annotations

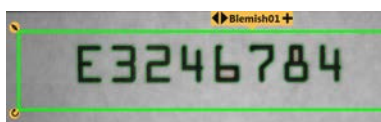
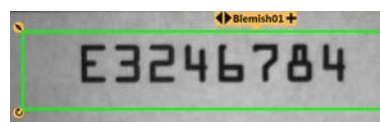

Figure 116. Hide Blemish Tool Annotations



Hide ROI

Hides the ROI when the tool is **not** selected.

Hide Masks

Hides the Mask ROI when the tool is **not** selected.

Tool Histogram

The Tool Histogram graphically displays pixel intensity information within the current ROI.

Figure 117. Example Histogram

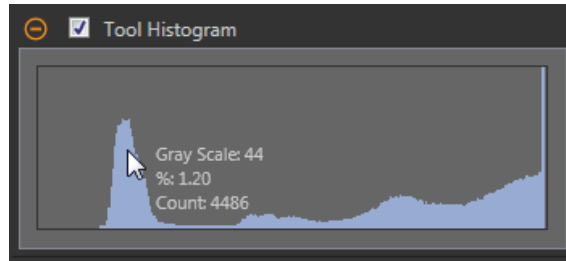

Select the **Tool Histogram** checkbox to enable the histogram. The default is enabled. Expand the **Tool Histogram** parameter to view the histogram.

The histogram is a display of the grayscale values on the x axis and the number of pixels on the y axis. The histogram displays the amount of pixels for each grayscale value. The graph displays information for all grayscale values (0 to 255). Move the pointer anywhere over the histogram to view specific information. The information updates as the position of the pointer changes.

Inspection Pass/Fail

Select the **Contribute to Inspection Pass/Fail** check box (default) if the tool will influence the Pass/Fail status of the inspection.

Figure 118. Inspection Pass/Fail

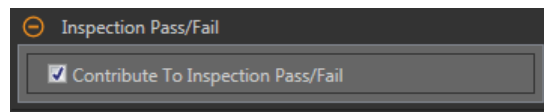

The Pass/Fail contribution influences the following:

- Discrete output Pass
- Discrete output Fail
- Pass/Fail results counter
- Pass (Green) and Fail (red) LEDs on the Sensor

Select this checkbox if the overall Pass/Fail status of the inspection is dependent on the current tool.

8.3.2 Blemish Tool: Test Parameters

Use the **Test** parameters to configure the pass/fail conditions for the tool.

Select the parameter checkbox to enable it. Where applicable, the vertical green bar shows the current parameter information and the light gray backgrounds show the range over which a value has varied over time.

Where applicable, use the sliders or enter the minimum and maximum for the selected test parameters.

The current data found and the range of historical data found are shown for applicable **Test** parameters. The historical data begins from the last reset.

Figure 119. Blemish Tool—Test Parameters

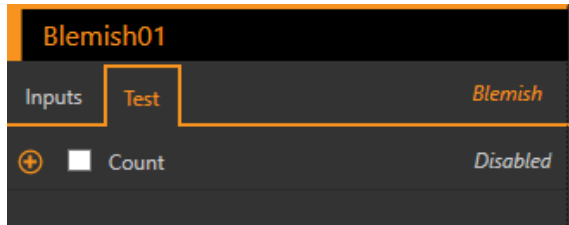
**Count**

The total number of edge pixels.

8.3.3 Blemish Tool: Results

Tools & Results and **All Results** list information from the current and previous inspections.

A red box around a tool indicates that the tool failed. **Status** provides information about the specific failure.

All Results displays the Result, Time, Pass Count, and Fail Count information at a glance. Expand the inspection tool to see specific results for that tool.

Count

The total number of edge pixels counted.

Length Range

The minimum and maximum edge lengths found.

Expand **Length Range** to see the minimum and maximum edge pixels counted, and the total edge pixels for each blemish.

Execution Time

The execution time, in milliseconds, for the currently selected tool in the current inspection.

Expand **Execution Time** to see the historical minimum and maximum execution times up to this point for the selected tool.

Use the reset button in the Inspection Summary to reset these historical values.

Status

Status and error messages display as appropriate.

8.3.4 Using the Blemish Tool

Follow these steps for an example Blemish inspection to check for a date/lot code on a product.



Note: This procedure is an example only.

1. Add a Blemish tool to the inspection.
2. Adjust the ROI to frame the date/lot code.
3. Set the sensitivity.
 - a) Expand the **Sensitivity** parameters.
 - b) Move the slider or enter 75 for this example.

A low sensitivity setting finds only high contrast edges, while a high sensitivity setting finds lower contrast edges as well. Note that the color does not matter; the tool will still find the edges of the date/lot code.

Figure 120. Light Date/Lot Code on a Dark Background



Figure 121. Dark Date/Lot Code on a Light Background

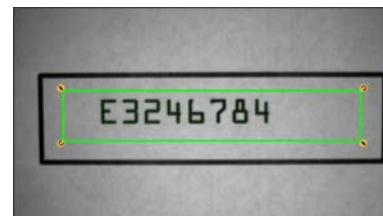

4. Leave the default minimum and maximum edge length range (100 px and 165000 px).

This defines how long the edge has to be before it is counted and how small it can be before it is ignored. Green means that the edge is within the criteria to be counted and yellow means it is outside of the criteria and is being ignored.

5. Set the Test parameters to set the pass/fail criteria.
 - a) On the **Test** tab, select the **Count** checkbox.
This option sets the number of edges that must be present within the ROI that match the inspection parameters so that the tool passes.
 - b) Move the sliders or enter the minimum count at 242 and the maximum count at 233230.
For example, a minimum and maximum count of 0 and 0 means that the part must have zero edges within the ROI that match the inspection parameters. In this case, the part must be blemish-free.



Note: The green bar indicates the current count and the light gray background indicate the count over time since the last reset.

6. Test a complete range of good and bad samples to make sure that the sensor accepts good parts and rejects bad parts.

Figure 122. Bad Part—Missing Date/Lot Code

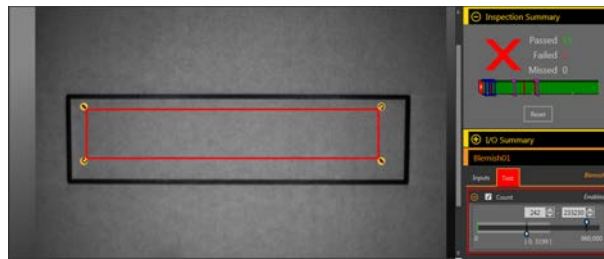

8.4 Blob Tool

Use the Blob tool to detect and count groups of like-colored pixels within the ROI.

A user-selected range of brightness levels defines the pixels of interest. Then, the Blob tool merges pixels of interest that touch each other into groups, called blobs. The Blob tool then counts the number of blobs in the ROI, calculates their size in pixel area, and defines each blob's center of mass location.

Example applications:

- Count pills
- Measure hole size
- Verify the number of characters in a date/lot code
- Detect LCD segments
- Detect missing products during packaging

8.4.1 Blob Tool: Input Parameters

Use the **Input** parameters to configure how the tool analyzes an image.

Figure 123. Blob Tool—Input Parameters

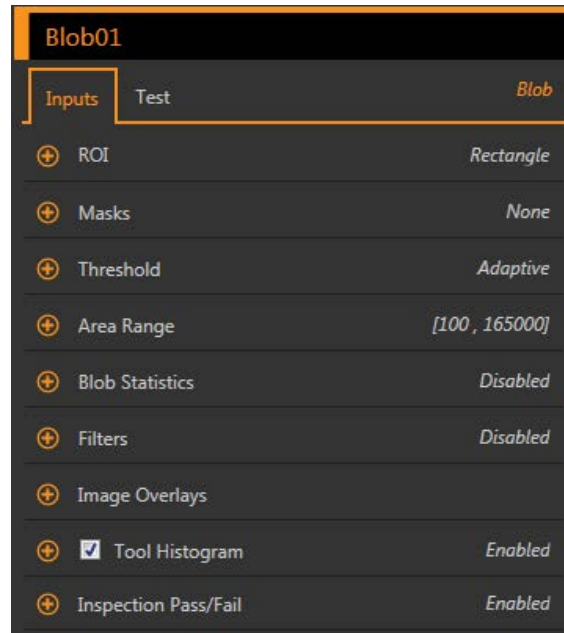



ROI

The Region of Interest (ROI) is the user-defined group of pixels in the image that the sensor analyzes.

Figure 124. ROI Shape Selection



Resize  and rotate  the ROI around the feature to be analyzed. Change the shape of the ROI to a square, ellipse, or circle as needed by expanding **ROI** on the **Parameters** pane and selecting the desired shape. An ROI can be as large as the entire Field of View (FOV). The ROI automatically displays on the **Image** pane when a tool is added.

Adjust the placement of the ROI more precisely by using the arrow keys on the computer keyboard.





Masks

Add and define a mask to exclude a group of pixels from the tool analysis.

Figure 125. Masks Parameters



A mask created for a tool will not apply to any other tool in the inspection. Up to 10 masks can be added to a tool.

1. Expand **Masks** on the **Inputs** tab.
2. Click . The mask ROI automatically displays on the **Image** pane.
3. Select the mask shape. The mask ROI can be rectangular, elliptical, or circular.
4. Resize  and rotate  the mask ROI around the pixels to be excluded.
5. To delete a mask, click .

Threshold

The threshold parameter is used to mark a transition point.

Threshold Type: Adaptive

Select Adaptive when there are lighting changes that cause the acquired image to change.

Figure 126. Threshold Type—Adaptive

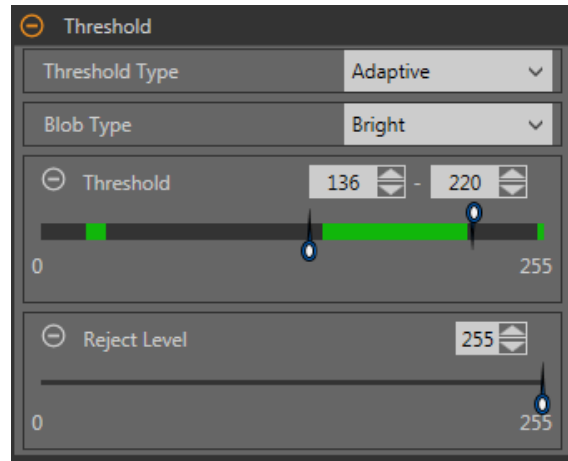

An adaptive threshold is a technique that adjusts the threshold for the tool based upon lighting changes and image content within the ROI. It performs best if used with bi-modal images, which have a clear contrast in the ROI. Adaptive threshold chooses the current threshold value by converging to a value based on the average value of the pixels above and below the previous threshold value; it will not move the value of the threshold above or below the minimum and maximum limits.

Adaptive Threshold: Bead/Blob Type

Defines whether the bead/blob is dark against a relatively brighter background or bright against a darker background.

This parameter defines the appearance of the feature of interest. For example, if you have a dark adhesive or part on a bright background, choose **Dark**.

Choosing **Dark** with an adaptive threshold type causes the tool to limit the threshold to the range specified by the threshold level minimum and maximum limits. The tool identifies all grouped pixels below the threshold chosen as dark beads/blobs.

Choosing **Bright** with an adaptive threshold type causes the tool to limit the threshold to the range specified by the threshold level minimum and maximum limits. The tool identifies all grouped pixels above the specified minimum limit and less than or equal to the maximum limit as bright beads/blobs.

Adaptive Threshold: Threshold

Use the sliders or enter the desired minimum and maximum possible grayscale threshold.

The green line is the current threshold value, chosen by the tool, and the sliders represent boundaries beyond which you do not want the tool to move the threshold settings.

Reject Level

When the Bead/Blob Type is set to Bright, use the **Reject Level** to narrow the range of pixel intensities to be considered in an inspection.

Leaving the defaults at 0 for low and 255 for high means that the tool takes into consideration all grayscale levels in the ROI from 0 (black) to 255 (white).

Reject Level Example

Consider setting up an inspection for a relatively bright object that ranges from 180 to 200 in pixel intensity and takes up 15 percent of the FOV. The remaining 85 percent of the FOV ranges from 230 to 255 in pixel intensity. Setting a Reject Level of 220 allows the tool to pay attention to only the bright object being inspected. Masking the bright parts of the FOV is not necessary because only pixels whose intensity is less than the Reject Level will contribute to bright beads/blobs.

Threshold Type: Fixed

Select **Fixed** when the lighting and image content remain relatively constant for all inspections.

Figure 127. Threshold Type—Fixed

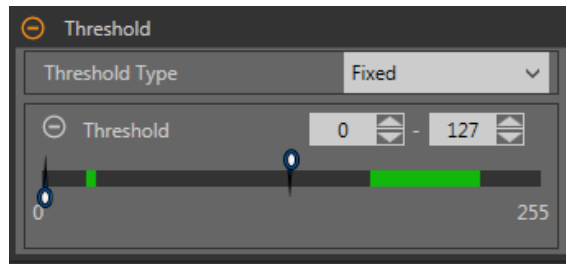

Fixed Threshold: Threshold

Use the sliders to define the range of brightness values of interest.

Area Range

Set the size range of blobs that the tool will count.

Figure 128. Area Range

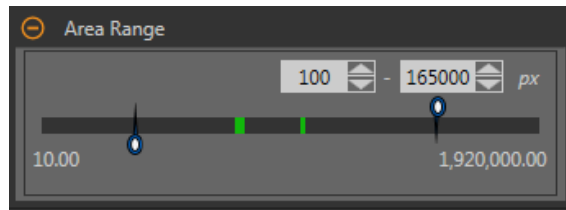

Green represents blobs that are within the set range, and yellow represents blobs that are outside of the set range.

Blob Statistics

Select to calculate and display advanced results on **Tools & Results** and **All Results**.

Figure 129. Blob Statistics

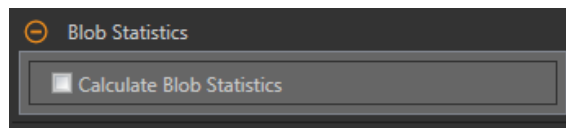

When enabled, Perimeter, Compactness, Major Axis Length, Minor Axis Length, Major Axis Angle, Eccentricity, Minimum Radius, Maximum Radius, Minimum Radius Position, Maximum Radius Position, Top Left Position X, Top Left Position Y, Bottom Right Position X, and Bottom Right Position Y are calculated in addition to Area and Centroid.

Filters

Set filters for tool analysis.

Figure 130. Blob Tool Filters

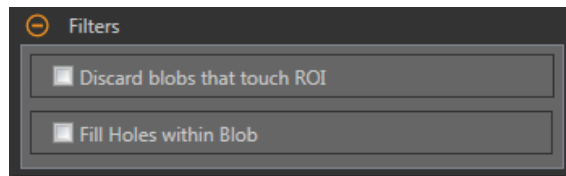

Discard Blobs that Touch ROI

Select to exclude blobs that touch the perimeter of the ROI.

Fill Holes within Blob

Select to ignore (by filling) small features such as scratches and glare that might otherwise appear as small imperfections or non-blobs within a larger blob. After selecting this option, use the slider or enter the size of the largest hole to fill.

Image Overlays

Choose whether to display or hide the annotations, ROI, or masks when this tool is **not** selected. Masks are hidden by default.

Figure 131. Image Overlays—Default

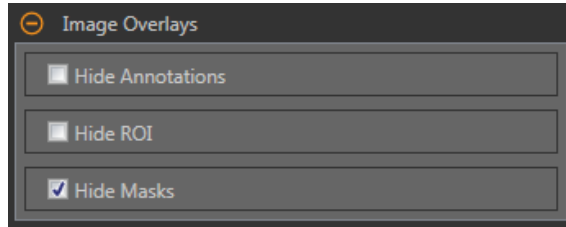

These options override the ROI view buttons  on the Image Pane Parameters when no tool is selected. When a specific tool is selected, the ROI information is shown.

Hide Annotations

Hides the annotations on the live image for the tool, even when the tool is selected.

Figure 132. Show Blob Tool Annotations

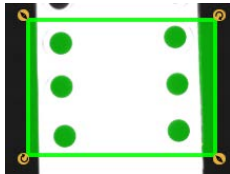
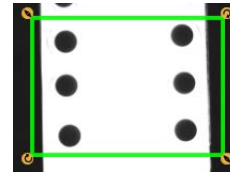

Figure 133. Hide Blob Tool Annotations



Hide ROI

Hides the ROI when the tool is **not** selected.

Hide Masks

Hides the Mask ROI when the tool is **not** selected.

Tool Histogram

The Tool Histogram graphically displays pixel intensity information within the current ROI.

Figure 134. Example Histogram

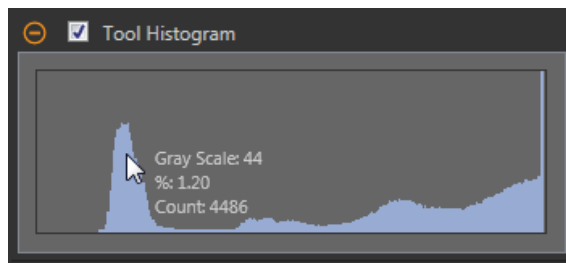

Select the **Tool Histogram** checkbox to enable the histogram. The default is enabled. Expand the **Tool Histogram** parameter to view the histogram.

The histogram is a display of the grayscale values on the x axis and the number of pixels on the y axis. The histogram displays the amount of pixels for each grayscale value. The graph displays information for all grayscale values (0 to 255). Move the pointer anywhere over the histogram to view specific information. The information updates as the position of the pointer changes.

Inspection Pass/Fail

Select the **Contribute to Inspection Pass/Fail** check box (default) if the tool will influence the Pass/Fail status of the inspection.

Figure 135. Inspection Pass/Fail

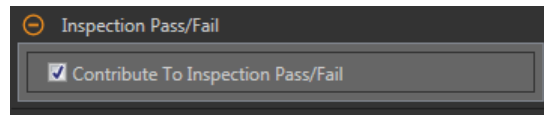

The Pass/Fail contribution influences the following:

- Discrete output Pass
- Discrete output Fail
- Pass/Fail results counter
- Pass (Green) and Fail (red) LEDs on the Sensor

Select this checkbox if the overall Pass/Fail status of the inspection is dependent on the current tool.

8.4.2 Blob Tool: Test Parameters

Use the **Test** parameters to configure the pass/fail conditions for the tool.

Select the parameter checkbox to enable it. Where applicable, the vertical green bar shows the current parameter information and the light gray backgrounds show the range over which a value has varied over time.

Where applicable, use the sliders or enter the minimum and maximum for the selected test parameters.

The current data found and the range of historical data found are shown for applicable **Test** parameters. The historical data begins from the last reset.

Figure 136. Blob Tool—Test Parameters

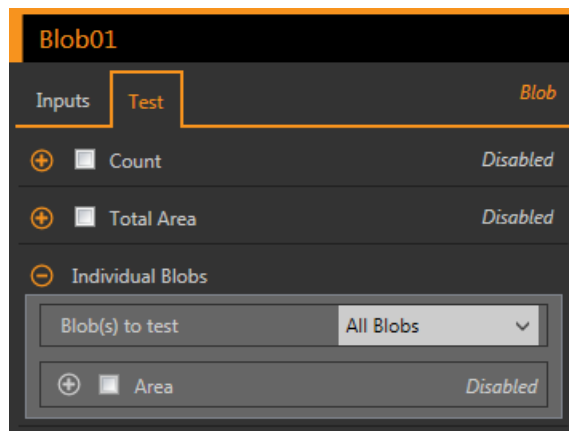

Count

The number of blobs found.

Total Area

The total area of all of the blobs found.

Individual Blobs

From the **Blob(s) to test** dropdown list, select **All Blobs**, **First Blob**, or **Specific Blob**, to view area and centroid information about the blobs.

When **Specific Blob** is selected, choose the specific blob using the **Blob Index**.

To verify if blobs within the ROI are of a specific area, select the **Area** checkbox and use the sliders or enter the minimum and maximum blob size.

When **Calculate Blob Statistics** is enabled, additional parameters for the selected blob become available. These include Perimeter, Compactness, Major Axis Length, Minor Axis Length, Eccentricity, Minimum Radius, Maximum Radius, Major Axis Angle, Top Left Position X, Top Left Position Y, Bottom Right Position X, and Bottom Right Position Y.

8.4.3 Blob Tool: Results

Tools & Results and **All Results** list information from the current and previous inspections.

A red box around a tool indicates that the tool failed. **Status** provides information about the specific failure.

All Results displays the Result, Time, Pass Count, and Fail Count information at a glance. Expand the inspection tool to see specific results for that tool.

Count

The number of blobs found.

Total Area

The total area of all of the blobs found.

Area Range

The minimum and maximum areas of the blobs found.
 Expand **Area Range** to see the area and centroid (center point) for each blob.
 Click a blob's area range to highlight that blob on the **Image** pane.

Statistics

Advanced statistical information about each blob.
 When enabled, Perimeter, Compactness, Major Axis Length, Minor Axis Length, Major Axis Angle, Eccentricity, Minimum Radius, Maximum Radius, Minimum Radius Position, Maximum Radius Position, Top Left Position X, Top Left Position Y, Bottom Right Position X, and Bottom Right Position Y are calculated in addition to Area and Centroid.
 Available when **Calculate Blob Statistics** is checked. See the following sections for more details.

Adaptive Threshold

The grayscale value for the software-selected threshold value used to generate the blobs.
 This result is blank if the threshold type is set to Fixed.

Execution Time

The execution time, in milliseconds, for the currently selected tool in the current inspection.
 Expand **Execution Time** to see the historical minimum and maximum execution times up to this point for the selected tool.
 Use the reset button in the Inspection Summary to reset these historical values.

Status

Status and error messages display as appropriate.

Area

The area (A) is a count of the total number of pixels that belong to the blob.

Centroid

The centroid (x_c, y_c) is the point at the center of mass of the blob.
 For simple blobs such as solid circles, ellipses, or rectangles, this is the center of the shape. For more complicated shapes it is helpful to imagine a piece of cardboard cut in the shape of the blob. The centroid is the point where you could balance the cardboard on the tip of a pencil. For complicated shapes—especially shapes with unfilled holes—the centroid might lie outside of the shape.
 The x coordinate of the centroid is calculated by adding the x coordinates of each pixel in the blob and dividing by the area. The y coordinate is similar:

$$x_c = \frac{\sum_{i=1}^A x_i}{A} \qquad y_c = \frac{\sum_{i=1}^A y_i}{A}$$

Perimeter

The perimeter (P) gives an approximate measurement of the length of the circumference of the blob.
 Because blobs are built from individual pixels, it is most practical to estimate the perimeter by counting the contributions of individual pixels on the blob's boundary. The following describes the exact values that are added to the perimeter for each possible pixel configuration. In each example, the description refers to the center pixel in the corresponding pictures.

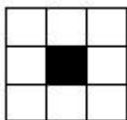

A pixel with no neighbors that belong to the same blob contributes 3.14 linear pixels to the perimeter of the blob. This can happen only in a blob that has an area of one. Since such small blobs are usually ignored, this circumstance is rare.

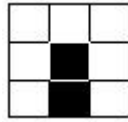
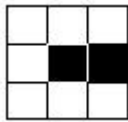

A pixel with one neighbor that belongs to the same blob contributes 2.571 linear pixels to the perimeter of the blob.

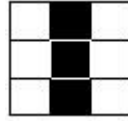
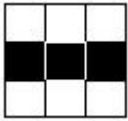

A pixel with two neighbors that belong to the same blob, forming a straight line, contributes exactly 2 linear pixels to the perimeter of the blob.

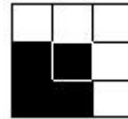
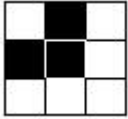

A pixel with two neighbors that belong to the same blob, forming a corner, contributes 1.414 linear pixels to the perimeter of the blob.

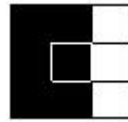
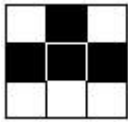

A pixel with three neighbors that belong to the same blob contributes exactly 1 linear pixel to the perimeter of the blob.

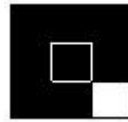
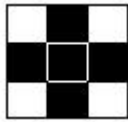

A pixel with four neighbors that belong to the same blob contributes nothing to the perimeter of the blob.

This method of counting slightly overestimates the "true" perimeter. For example, a circle with a radius of 100 pixels has a computed perimeter of approximately 660 pixels, compared with the expected value of 628 pixels.

If the sensor is configured to convert pixel distances to other units, (for example, millimeters), the perimeter is given in those units. If the blob contains holes that have not been filled, the length of the perimeter includes the points on the perimeters of these holes.

Compactness

Compactness is a measurement of the space a blob occupies.

The compactness is high for blobs that are nearly circular and low for blobs that are elongated or complicated.

$$\text{compactness} = \frac{400 \pi A}{P^2}$$

Where A is the area and P is the perimeter of the Blob in question. An idealized circle would have a compactness of 100, but because the perimeter is approximated (see above), the highest realistic value for most blobs is roughly 90. Very small blobs with just a handful of pixels may reach or even exceed the theoretical maximum of 100, again because of the approximations in the perimeter calculation.

Major Axis Length, Minor Axis Length, and Major Axis Angle

Major Axis Length, Minor Axis Length, and Major Axis Angle are determined using a best fit ellipse.

To understand Major Axis Length, Minor Axis Length, and Major Axis Angle, it is important to note that these are not measurements of the blob itself because the blob may be an irregular shape. Rather, these measurements are determined by a well-defined shape, a "best fit ellipse".

Figure 137. Best Fit Ellipse

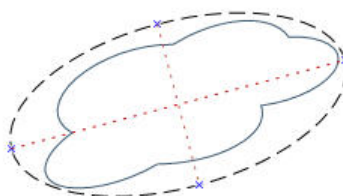

These three results combine to give information about the elongation and orientation of a blob . The equations used to compute these statistics are complicated, but the results usually have an intuitively useful meaning, described below. The first step in computing these results is to compute the $M_{2,0}$, $M_{0,2}$ and $M_{1,1}$ statistical moments:

$$M_{2,0} = \frac{\sum_{i=1}^A (x_i - x_c)^2}{A}$$

$$M_{0,2} = \frac{\sum_{i=1}^A (y_i - y_c)^2}{A}$$

$$M_{1,1} = \frac{\sum_{i=1}^A ((x_i - x_c)(y_i - y_c))}{A}$$

where A is the area, (x_c, y_c) are the coordinates of the centroid, and (x_i, y_i) are the coordinates of pixel i. These values represent the variance with respect to x, the variance with respect to y, and the covariance, respectively. The final results can be calculated as follows:

$$\text{Major Axis Length} = 2\sqrt{2\left(M_{2,0} + M_{0,2} + \sqrt{4M_{1,1}(M_{2,0} - M_{0,2})^2}\right)}$$

$$\text{Minor Axis Length} = 2\sqrt{2\left(M_{2,0} + M_{0,2} - \sqrt{4M_{1,1}(M_{2,0} - M_{0,2})^2}\right)}$$

$$\text{Major Axis Angle} = \frac{\tan^{-1}\left(\frac{2M_{1,1}}{M_{2,0} - M_{0,2}}\right)}{2}$$

The following table gives a more practical perspective on how to interpret these results. If the sensor is configured to convert pixels to other units, the major and minor axis lengths are given in those units. The major axis angle is always given in degrees.

Blob Shape	Meaning of Major Axis Length	Meaning of Minor Axis Length	Meaning of Major Axis angle
Circular, no holes	Diameter of the circle	Equal to the major axis length	Unstable
Elliptical, no holes	Length of the ellipse	Width of the ellipse	Orientation of the ellipse
Square, no holes	Diameter of a circle that best approximates the square	Equal to the major axis length	Unstable
Rectangular, no holes	Length of an ellipse that best approximates the rectangle	Width of an ellipse that best approximates the rectangle	Orientation of the rectangle
Complicated shape, no holes	Length of an ellipse that best approximates the shape	Width of an ellipse that best approximates the shape	Orientation of the shape—unstable if length and width are nearly equal
Any shape with holes	Results vary depending on exact shape—experiment on your particular shape	Results vary depending on exact shape—experiment on your particular shape	Results vary depending on exact shape—experiment on your particular shape

Eccentricity

The eccentricity of a blob is the length of the major axis divided by the length of the minor axis.

For circular regions and other regions with radial symmetry (such as a square), the value will be very close to 1. For elongated regions, the value will increase.

Max Radius and Max Radius Position

The Maximum Radius of a blob is the distance from the centroid of the blob to the farthest pixel on that blob's perimeter. The Maximum Radius Position gives the pixel coordinates of that farthest perimeter point.

If the sensor is configured to convert pixels to other units, the maximum radius will be given in those units.

Min Radius and Min Radius Position

The Minimum Radius of a blob is the distance from the centroid of the blob to the closest pixel on that blob's perimeter. The Minimum Radius Position gives the pixel coordinates of that closest perimeter point.

If the blob contains unfilled holes, the minimum radius position may be on the perimeter of a hole. If the sensor is configured to convert pixels to other units, the minimum radius will be given in those units.

Top Left Position X, Top Left Position Y, Bottom Right Position X, and Bottom Right Position Y

The top left and bottom right coordinates are determined using a bounding box around each blob. These positions represent the maximum and minimum coordinates of each blob.

Figure 138. Blob Bounding Box

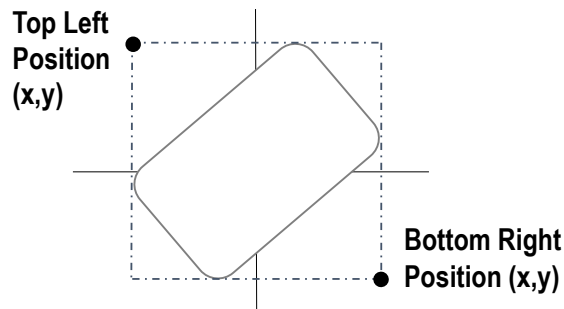

8.4.4 Using the Blob Tool

Follow these steps for an example blob inspection in a pill counting application.



Note: This procedure is an example only.

1. Add a Blob tool to the inspection.
2. Adjust the ROI to frame the first set of pills in the blister pack.

Figure 139. Adjust ROI

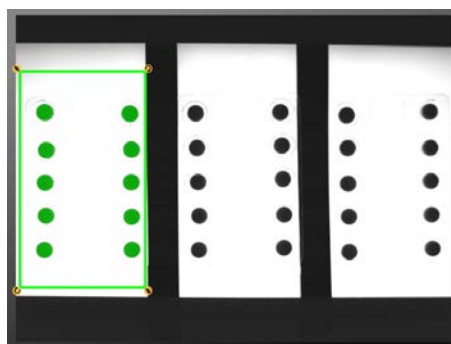

3. Set the threshold.

- a) Expand the **Threshold** parameters.
- b) From the **Threshold Type** list, select **Fixed**.
Select Fixed when the lighting and image content remain relatively constant for all inspections.
- c) Expand the second **Threshold** parameters.
- d) Move the sliders to define the minimum and maximum threshold.
This sets a minimum and maximum brightness within the ROI to include or exclude.

Figure 140. Threshold

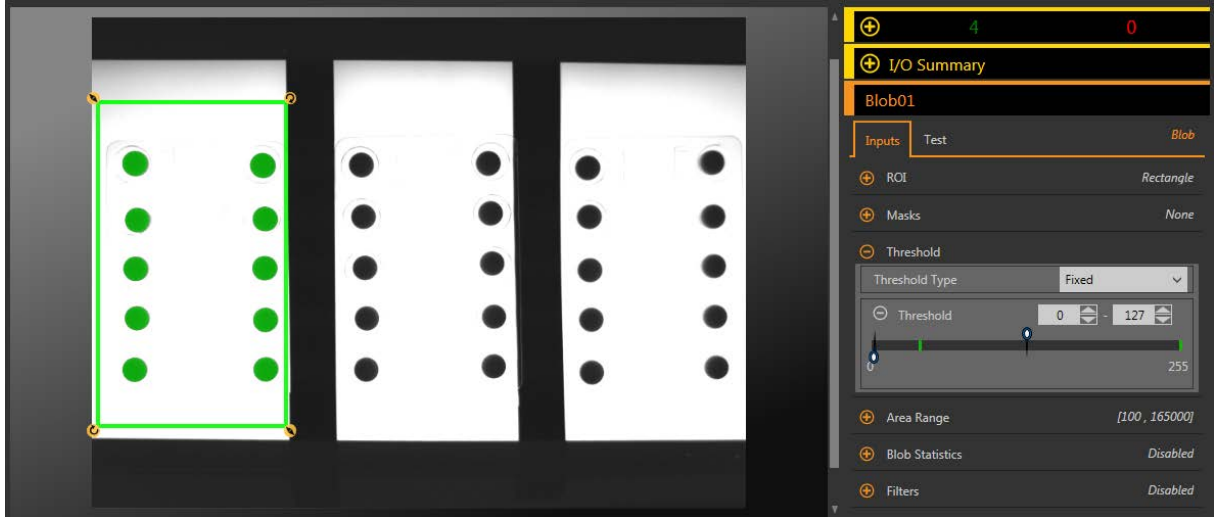

4. Set the area range.
This defines the size range of pixel groups to include or exclude.
 - a) Expand the **Area Range** parameters.
 - b) Move the sliders to define the minimum and maximum size of pixel groups.
Yellow indicates that a group of pixels is outside of the set range.

Figure 141. Area Range

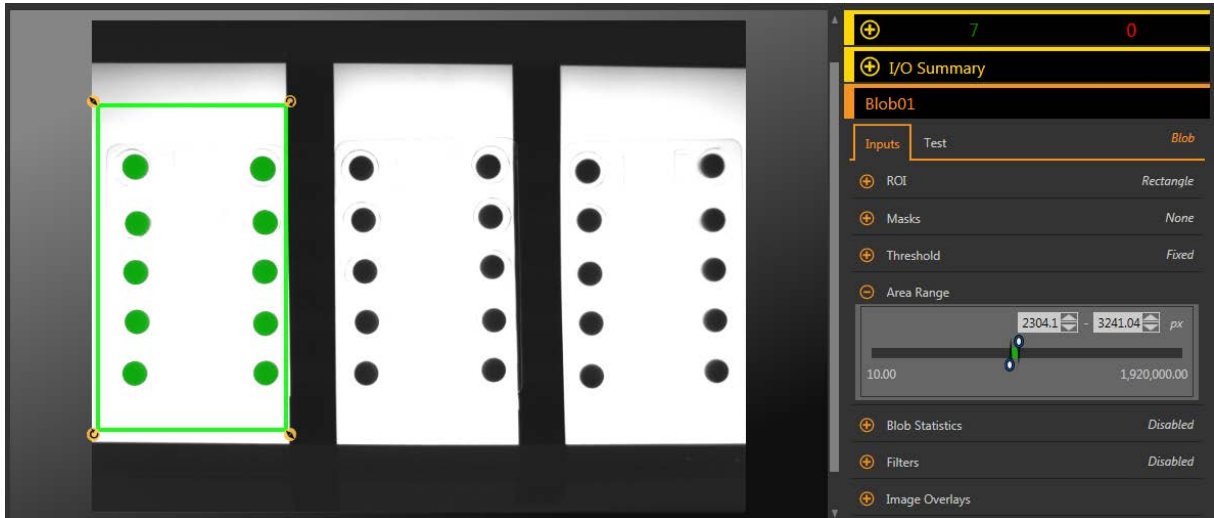

5. Set the Test parameters to set the pass/fail criteria.
 - a) On the **Test** tab, select the **Count** checkbox to enable the test parameter.
This option sets the number of blobs that must be present within the ROI that match the inspection parameters so that the tool passes.
 - b) Expand **Count** and move the sliders or enter the minimum and maximum count as 10 and 10.



Note: The green bar indicates the current count and the light gray background indicates the count over time.

6. Copy the Blob tool.



- a) With the Blob tool selected, click .
The tool and all of the settings are duplicated (copied) and all of the tools are deselected.
 - b) Select one of the Blob tools and click  a second time.
There are now three Blob tools with the same settings.
7. Click Blob02 (the second Blob tool) and move the ROI over the second blister pack.
 8. Click Blob03 (the third Blob tool) and move the ROI over the third blister pack.
 9. Click  to show all three ROI at the same time.
 10. Test a complete range of good and bad samples to make sure that the sensor accepts good parts and rejects bad parts.

Figure 142. Bad Part—Missing Pill

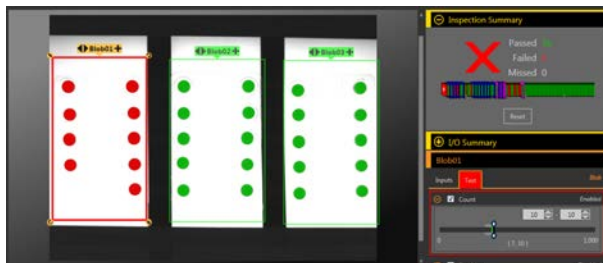
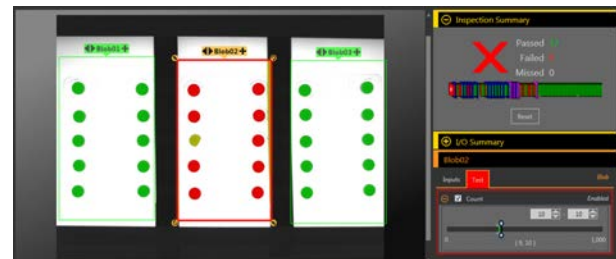

Figure 143. Bad Part—Broken Pill



8.5 Circle Detect Tool

Use the Circle Detect tool to find a single circle or a piece of a circle (arc).

The Circle Detect tool finds many edge points along the transitions between bright and dark pixels and then fits a circular shape to some or all of these points. The tool can determine a bend radius and the circumference of a circular part. The tool finds only one circle within the ROI—either the best circle (using the Best Points option) or the average circle (using the All Points option).

Example applications:

- Find flaws such as chips or metal spurs along a punched or drilled hole
- Measure hole size
- Measure the size of a disk
- Verify that the neck on a vial or bottle is the correct size
- Measure the bend radius of an electronic component
- Find the radius of a circle that is too big to fit in the image

8.5.1 Circle Detect Tool: Input Parameters

Use the **Input** parameters to configure how the tool analyzes an image.

Figure 144. Circle Detect Tool—Input Parameters

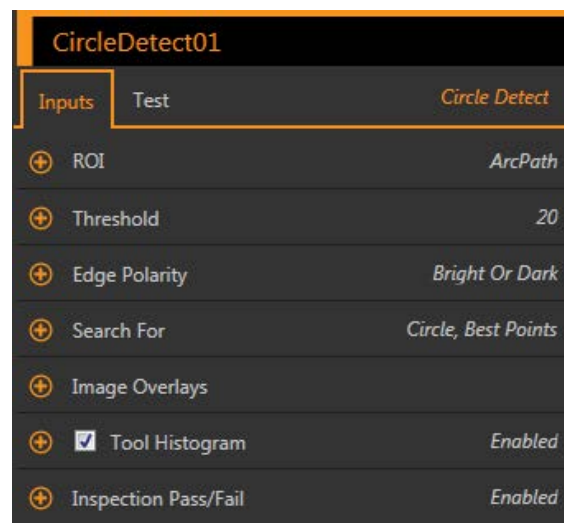



ROI

The Region of Interest (ROI) is the user-defined group of pixels in the image that the sensor analyzes.

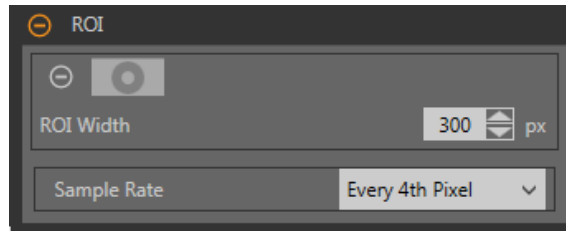
Figure 145. Circle Detect Tool ROI



The ROI is two concentric circles that can also be configured as an arc. Resize  or reshape  the ROI around the feature to be analyzed. Tool analysis follows the direction of the arrow. The ROI automatically displays on the **Image** pane when a tool is added.

Adjust the placement of the ROI more precisely by using the arrow keys on the computer keyboard.

Use the two circles to surround the specific circle of interest and avoid other edges, and to improve the execution time by reducing the number of pixels that are analyzed.

ROI Width

Larger ROIs find more edges, however if too many edges are outliers, the desired circle may not be found. Smaller ROIs execute faster.

The tool works best when the inner ring of the ROI is completely inside the circle being detected, and when the ROI and the circle being detected are concentric.

Sample Rate

The sample rate sets the spacing between scan lines along the width of the ROI (one sample for every pixel, one sample every second pixel, etc.). When the sample rate includes more pixels, more edges, more precise results, and small flaws are found. The highest sample rate is **Every Pixel**. When the sample rate includes fewer pixels, fewer, more widely spaced edges are found. The lowest sample rate is **Every 64th Pixel**. This creates a trade-off between speed and precision. Lower sample rates execute faster, and higher sample rates find more precise results and are capable of detecting smaller flaws.

Threshold

Indicates the rate of change of grayscale values that is needed to detect an edge.

Figure 146. Threshold Parameters

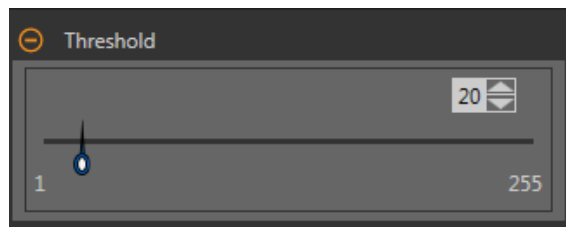

Edges are detected by measuring transitions from bright to dark or dark to bright. Enter a threshold in the range from 1 to 255. The default value is 20. As this value is reduced, the tool finds weak, blurry, or more gradual lines or edges. At lower thresholds, unwanted transitions such as background noise may become edges. Detected edges are combined to find potential circles.

Edge Polarity

Edge Polarity defines the type of edges that the tool finds.

- Dark to Bright—Finds edges where pixel intensities start below the threshold value and cross above the threshold value
- Bright to Dark—Finds edges where pixel intensities start above the threshold value and cross below the threshold value
- Bright or Dark—Finds any edge

Search For

Set the type of object that the Line Detect tool searches for.

Circle, Best Points

Automatically determines which edge points make the best circle and ignores the rest of the points. The points that are included are shown on the image in orange, while the points that are ignored are in yellow. Best Points is tolerant of noise or extra edges in the ROI, but under some circumstances, it may ignore edges that should be included.

Circle, All Points

Finds a circle that explains all of the edges as well as possible; all found points are included in the analysis. Found points are shown on the image in orange. All Points is faster than Best Points, but works poorly if there are extra edges or noise within the ROI. All Points is useful if the circle being examined is irregular or elliptical.

Circular Arc

Finds a piece of a circle. Use this setting to find the start or end angle of an arc or bend or to measure the angle subtended by a bend. Circular Arc mode operates on best points.

Image Overlays

Choose whether to display or hide the annotations or the ROI when this tool is **not** selected.

Figure 147. Image Overlays—Default

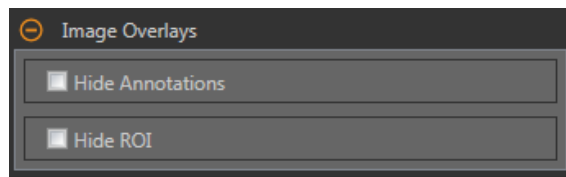

These options override the ROI view buttons  on the Image Pane Parameters when no tool is selected. When a specific tool is selected, the ROI information is shown.

Hide Annotations

Hides the annotations on the live image for the tool, even when the tool is selected.

Figure 148. Show Circle Detect Tool Annotations

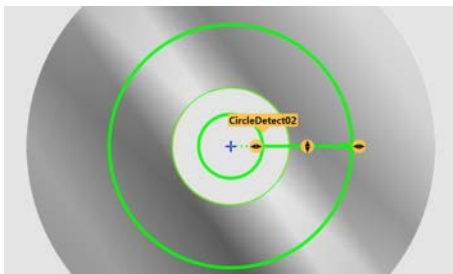
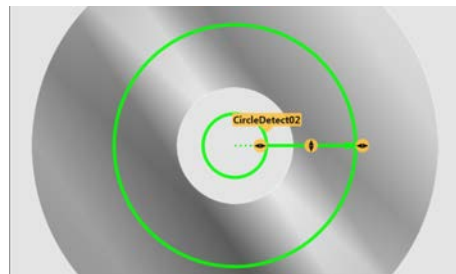

Figure 149. Hide Circle Detect Tool Annotations



Hide ROI

Hides the ROI when the tool is **not** selected.

Tool Histogram

The Tool Histogram graphically displays pixel intensity information within the current ROI.

Figure 150. Example Histogram

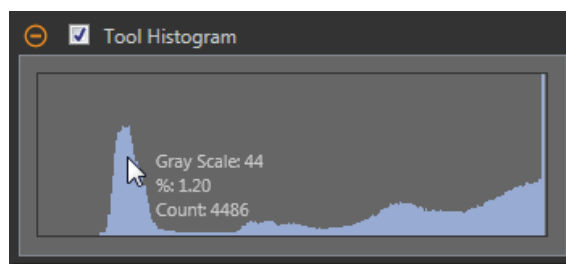

Select the **Tool Histogram** checkbox to enable the histogram. The default is enabled. Expand the **Tool Histogram** parameter to view the histogram.

The histogram is a display of the grayscale values on the x axis and the number of pixels on the y axis. The histogram displays the amount of pixels for each grayscale value. The graph displays information for all grayscale values (0 to 255). Move the pointer anywhere over the histogram to view specific information. The information updates as the position of the pointer changes.

Inspection Pass/Fail

Select the **Contribute to Inspection Pass/Fail** check box (default) if the tool will influence the Pass/Fail status of the inspection.

Figure 151. Inspection Pass/Fail

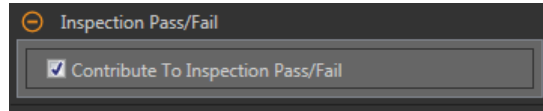

The Pass/Fail contribution influences the following:

- Discrete output Pass
- Discrete output Fail
- Pass/Fail results counter
- Pass (Green) and Fail (red) LEDs on the Sensor

Select this checkbox if the overall Pass/Fail status of the inspection is dependent on the current tool.

8.5.2 Circle Detect Tool: Test Parameters

Use the **Test** parameters to configure the pass/fail conditions for the tool.

Select the parameter checkbox to enable it. Where applicable, the vertical green bar shows the current parameter information and the light gray backgrounds show the range over which a value has varied over time.

Where applicable, use the sliders or enter the minimum and maximum for the selected test parameters.

The current data found and the range of historical data found are shown for applicable **Test** parameters. The historical data begins from the last reset.

Figure 152. Circle Detect Tool—Test Parameters

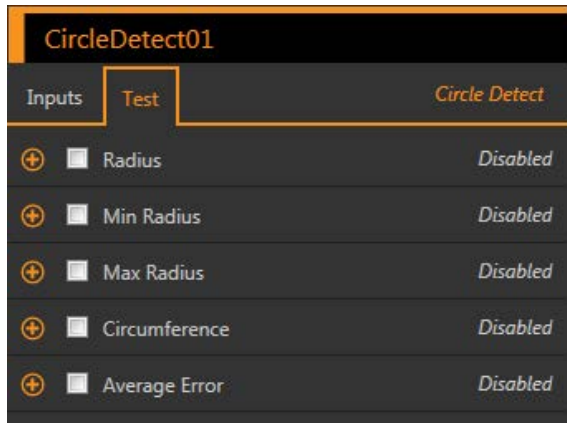
**Radius**

The distance from the center of the detected circle to its edges.

Use this value to determine if a circle is the correct size.

Min Radius

The distance from the center of the circle to the closest included edge point.

Use this value to look for flaws such as metal spurs on the inside of a drilled or punched hole.

Max Radius

The distance from the center of the circle to the farthest included edge point.

Use the value to find flaws such as chips or tearing on the outside of a punched or drilled hole.

Circumference

The distance around the circle.

Available when **Search For** is set to **Circle, Best Points** or **Circle, All Points**.

Arc Length

The distance along the arc.

Available when **Search For** is set to **Circular Arc**.

Arc Angle

The angle between the start and the end of the arc.

Available when **Search For** is set to **Circular Arc**.

Average Error

The average distance between included edge points and the circle found.

Use this value to determine if a circle is squished (elliptical), poorly formed, or irregular.

8.5.3 Circle Detect Tool: Results

Tools & Results and **All Results** list information from the current and previous inspections.

A red box around a tool indicates that the tool failed. **Status** provides information about the specific failure.

All Results displays the Result, Time, Pass Count, and Fail Count information at a glance. Expand the inspection tool to see specific results for that tool.

Center

The x and y coordinates of the center of the found circle. This point can be used as inputs to other tools.

Radius

The distance from the center of the detected circle to its edges.

Min Radius

The distance from the center of the circle to the closest included edge point.

Min Radius Point

The x and y coordinates of the include edge point located closest to the center of the circle or arc.

Max Radius

The distance from the center of the circle to the farthest included edge point.

Max Radius Point

The x and y coordinates of the included edge point located farthest from the center of the circle or arc.

Circumference

The distance around the circle.

Available when **Search For** is set to **Circle, Best Points** or **Circle, All Points**.

Arc Length

The distance along the arc.

Available when **Search For** is set to **Circular Arc**.

Arc Angle

The angle between the start and the end of the arc.

Available when **Search For** is set to **Circular Arc**.

Arc Start

The angle between the x-axis and the beginning of the arc. This is between -180 and +180 degrees.

Available when **Search For** is set to **Circular Arc**.

Arc End

The angle between the x-axis and the end of the arc. This is between -180 and +180 degrees.

Available when **Search For** is set to **Circular Arc**.

Average Error

The average distance between included edge points and the circle found.

Execution Time

The execution time, in milliseconds, for the currently selected tool in the current inspection.

Expand **Execution Time** to see the historical minimum and maximum execution times up to this point for the selected tool.

Use the reset button in the Inspection Summary to reset these historical values.

Status

Status and error messages display as appropriate.

8.5.4 Using the Circle Detect Tool

Follow these steps for a typical Circle Detect inspection to check for flashing, spurs, or cracks in a disk.



Note: This procedure is an example only.

1. Add a Circle Detect tool to the inspection to check the outer edge of the disk.
2. Adjust the ROI to frame the outside edge of the disk.
 - a) Move the ROI so that it is concentric with the disk.
 - b) Expand the outer ring of the ROI to frame the disk. Leave some space around the disk to ensure that flashing or spurs are found.
 - c) Adjust the inner ring of the ROI so that the hole in the disk is exclude from the inspection.

Figure 153. Circle Detect ROI—Outer Edge Detection

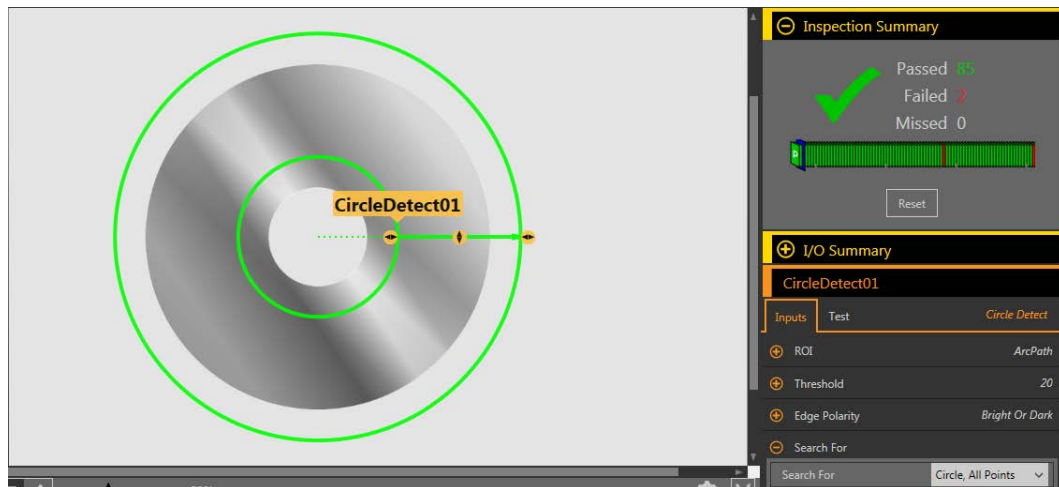

3. Set the **Input** parameters.
 - a) Expand the **Search For** parameter.
 - b) Select **Circle, All Points** from the list.
4. Set the **Test** parameters to set the pass/fail criteria.
 - a) Select the **Average Error** checkbox.
This option looks at the average distance between included edge points and the circle found.
 - b) Set the range from 0 px to 3 px.
5. Add a Circle Detect tool to the inspection to check the hole in the disk.
6. Adjust the ROI to frame the hole in the disk.
 - a) Move the ROI so that it is concentric with the disk.
 - b) Reduce the outer ring of the ROI to frame the hole.
 - c) Adjust the inner ring of the ROI so that the entire hole is included in the inspection.

Figure 154. Circle Detect ROI—Hole Edge Detection

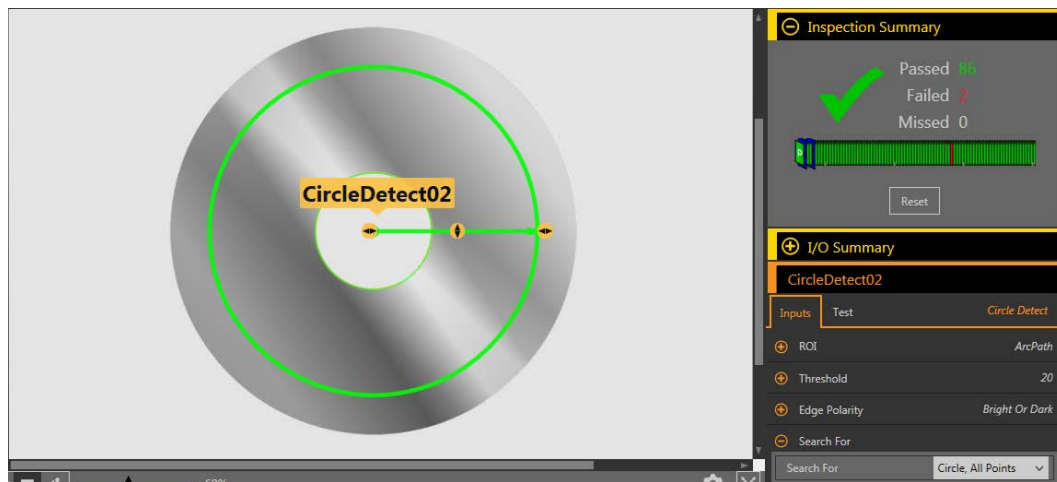

7. Set the **Input** parameters.
 - a) Expand the **Search For** parameter.
 - b) Select **Circle, All Points** from the list.
8. Set the **Test** parameters to set the pass/fail criteria.
 - a) Select the **Average Error** checkbox.
 - b) Set the range from 0 px to 3 px.
9. Test a complete range of good and bad samples to make sure that the sensor accepts good parts and rejects bad parts.

Figure 155. Bad Part—Flashing

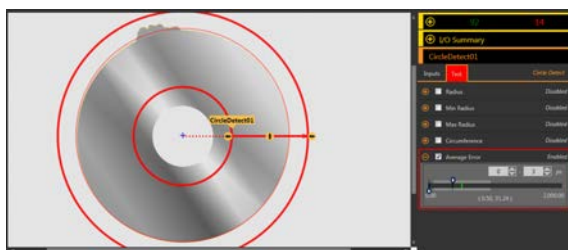

Note: The flashing on the outer edge fails only the first Circle Detect tool in this example.

Figure 156. Bad Part—Crack

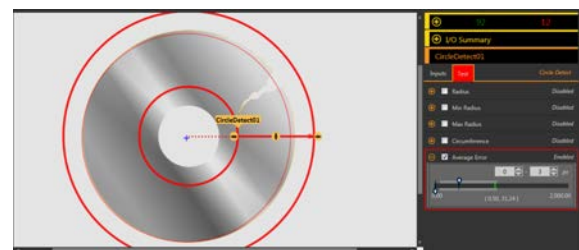

Note: This crack fails both of the Circle Detect tools in this example.

8.6 Edge Tool

Use the Edge tool to detect and count transitions between bright and dark pixels (edges).

The Edge tool counts the total number of edges, and determines the position of each edge. Edge position information can be used for distance or angle measurements when used with a Measure tool.

Example applications:

- Measure the height and width of a part
- Count the pins on an integrated circuit
- Measure the height of a needle
- Measure the deflection of an automotive gauge
- Detect the edge of a web
- Verify that a bottle cap is on completely

8.6.1 Edge Tool: Input Parameters

Use the **Input** parameters to configure how the tool analyzes an image.

Figure 157. Edge Tool—Input Parameters

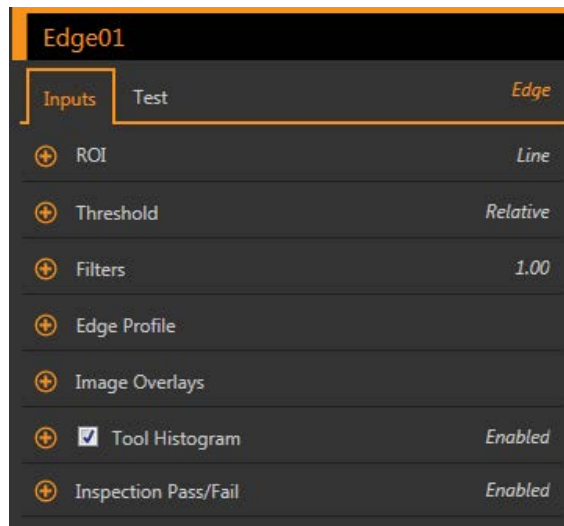

ROI

The Region of Interest (ROI) is the user-defined group of pixels in the image that the sensor analyzes.

Figure 158. ROI Parameters

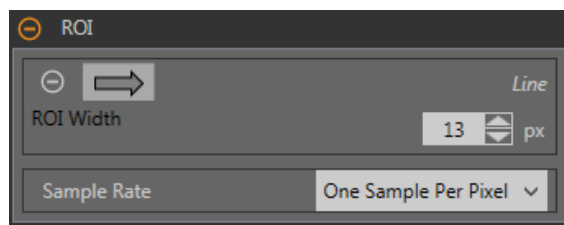

The ROI is a line of pixels that can be shortened, lengthened, or widened as needed for the inspection. Tool analysis follows the direction of the arrow. Set the width and the sample rate for the region of interest. The ROI automatically displays on the **Image** pane when a tool is added.

Adjust the placement of the ROI more precisely by using the arrow keys on the computer keyboard.

ROI Width

An ROI can be as large as the entire Field of View (FOV).

Note that:

- Narrow ROIs execute faster but could miss the edge
- Wide ROIs are more consistent but don't execute as fast
- A wide ROI provides an average value/location, which results in improved repeatability
- The ROI must be 13 pixels or wider to calculate the rotation of a part (Locate tool only)

Sample Rate

The sample rate sets the number of samples per pixels (one sample per pixel, two samples per pixel, etc.). The sample rate determines the sub-pixel resolution, which increases the resolution of the tool, and increases the inspection time.

Figure 159. 1 px Wide ROI

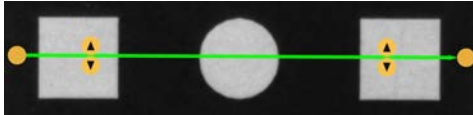
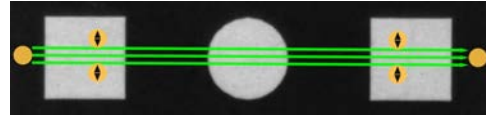

Figure 160. 13 px Wide ROI



Threshold

The Threshold parameter marks the grayscale transition point.

The tool marks the edge where the pixel intensity crosses the threshold level. From the **Threshold Type** list, select one of the following:

- Absolute
- Relative (default)
- Edge Strength

Threshold Type: Absolute

Finds an edge at a specific grayscale level.

Figure 161. Absolute Threshold Parameters

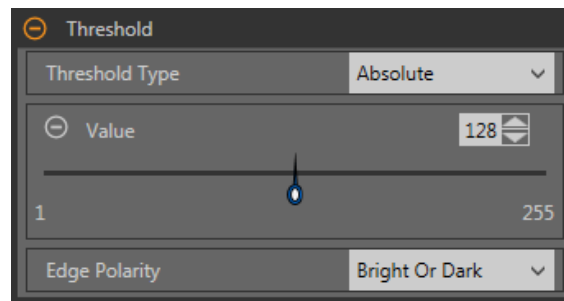

While Absolute threshold is less likely to find a false edge than Relative threshold, it may miss edges if the light level changes between inspections.

Absolute Threshold: Value

Enter a specific grayscale value from 0 to 255.

Edge Polarity

Edge Polarity defines the type of edges that the tool finds.

- Dark to Bright—Finds edges where pixel intensities start below the threshold value and cross above the threshold value
- Bright to Dark—Finds edges where pixel intensities start above the threshold value and cross below the threshold value
- Bright or Dark—Finds any edge

Absolute Threshold: Edge Profile Graph

Figure 162. Absolute Threshold—Edge Profile Graph

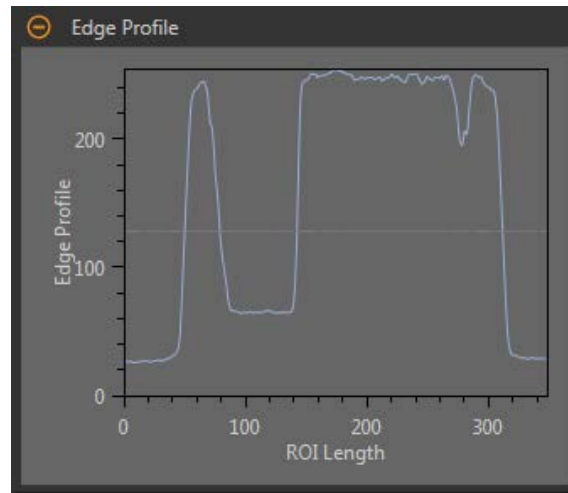

For absolute threshold, the x axis is the length of the ROI. The y axis is the actual grayscale value from 0 to 255. The light blue line shows the absolute pixel intensity. The horizontal gray threshold line moves up or down with the threshold value. Point to a location on the graph—the corresponding location is the yellow line on the tool ROI displayed on the image.

Threshold Type: Relative

Finds an edge at a relative pixel intensity. This is the default threshold setting.

Figure 163. Relative Threshold Parameters

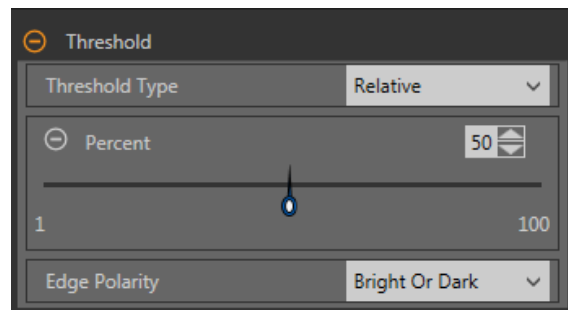

The brightest grayscale level found along the ROI is 100% and the darkest is 0%. While Relative threshold is more tolerant of light fluctuations between inspections than other transition types, it may find false edges.

Relative Threshold: Percent

Choose the percentage value at which the edge should be marked.

Edge Polarity

Edge Polarity defines the type of edges that the tool finds.

- Dark to Bright—Finds edges where pixel intensities start below the threshold value and cross above the threshold value
- Bright to Dark—Finds edges where pixel intensities start above the threshold value and cross below the threshold value
- Bright or Dark—Finds any edge

Relative Threshold: Edge Profile Graph

Figure 164. Relative Threshold—Edge Profile Graph

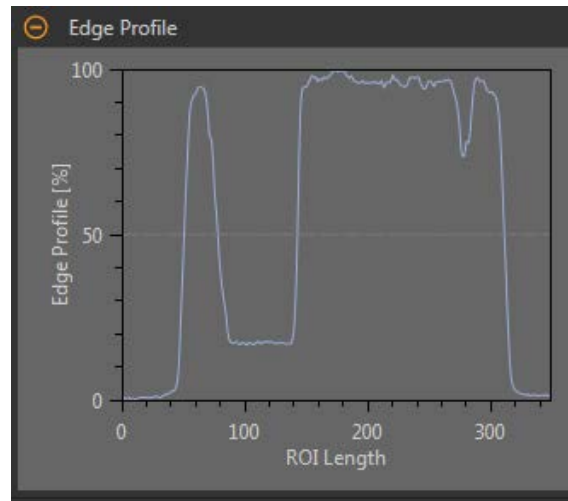

For relative threshold, the x axis is the length of the ROI. The y axis is the pixel intensity along the ROI, with 0% as the darkest pixel in the ROI and 100% as the lightest pixel in the ROI. The light blue line shows the percentage pixel intensity relative to the horizontal gray threshold line. The threshold line moves up or down with the percent value.



Note: Because the pixel intensity is relative to what is seen in the ROI, this does not necessarily mean that 0% = pure black or that 100% = pure white.

Point to a location on the graph—the corresponding location is the yellow line on the tool ROI displayed on the image.

Threshold Type: Edge Strength

Measures the rate of change of grayscale values and needs sharply-defined transitions to find edges.

Figure 165. Edge Strength Threshold Parameters

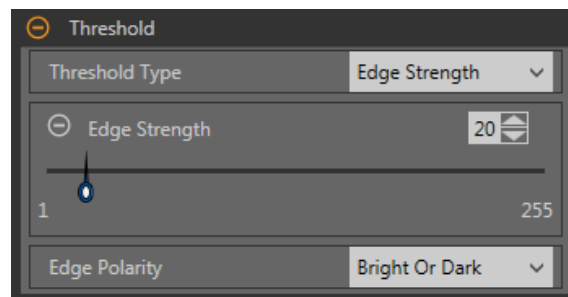

Edge strength ignores gradual changes in light levels across the tool better than other threshold types and it filters out weak or gradual edges.

Edge Strength Threshold: Edge Strength

Enter an edge strength value from 1 to 255.

Edges are selected by the edge strength method, which measures the rate of change from bright to dark or dark to bright. Enter an edge strength threshold in the range from 1 to 255. The default value is 20. As this value is reduced, the tool finds weak, blurry, or more gradual edges.

Edge Polarity

Edge Polarity defines the type of edges that the tool finds.

- Dark to Bright—Finds edges where pixel intensities start below the threshold value and cross above the threshold value
- Bright to Dark—Finds edges where pixel intensities start above the threshold value and cross below the threshold value
- Bright or Dark—Finds any edge

Edge Strength Threshold: Edge Profile Graph

Figure 166. Edge Strength Threshold—Edge Profile Graph

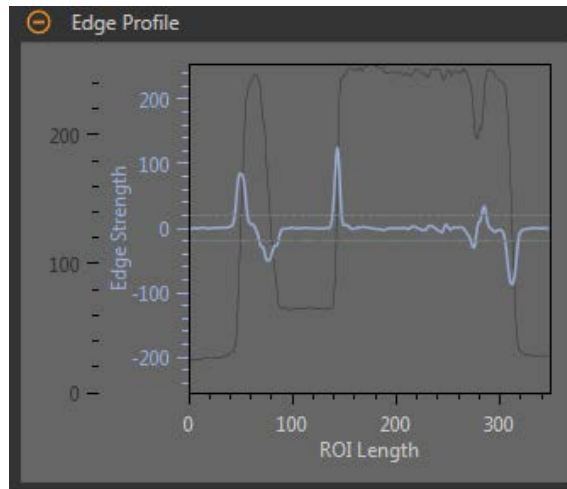

For edge strength threshold, the x axis is the length of the ROI. The y axis has two measurements. The first is the light blue axis. It represents Edge Strength, a measure of the rate of change of pixel grayscale values. The second is the dark gray axis. It represents Edge Profile, which gives the absolute grayscale level across the tool ROI. The blue line is the rate of change of the grayscale value along the ROI. The two horizontal gray lines are the edge strength threshold plus and minus. Point to a location on the graph—the corresponding location is the yellow line on the tool ROI displayed on the image.

Filters

Set filters for tool analysis.

Figure 167. Edge Tool Filters

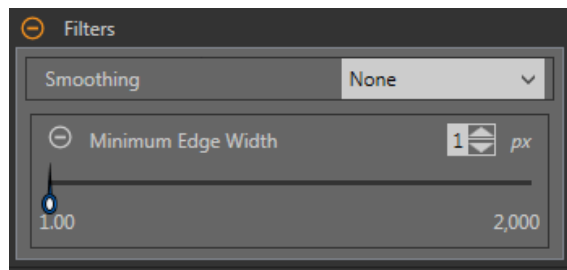

Smoothing

Runs a rolling average along the ROI length. Smoothing filters out sharp changes in the edge profile.



Note: A high filter number may miss the edge of a narrow line.

Minimum Edge Width

Filters out small spike-of-intensity changes, and narrow dark or bright bands. It determines the distance before and after an edge that must be free from additional transitions or the end of the ROI before the edge is recognized as valid.



Note: A high filter number may miss the edge of a narrow line.

Edge Profile

The Edge Profile graph changes depending on which threshold type is selected. Refer to the Threshold section and the specific threshold types for details on the Edge Profile graph.

Image Overlays

Choose whether to display or hide the annotations or the ROI when this tool is **not** selected.

Figure 168. Image Overlays—Default

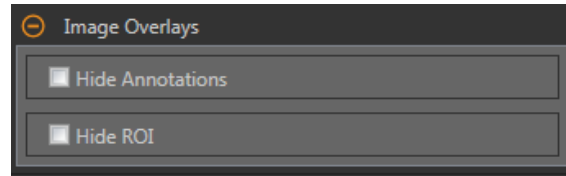

These options override the ROI view buttons  on the Image Pane Parameters when no tool is selected. When a specific tool is selected, the ROI information is shown.

Hide Annotations

Hides the annotations on the live image for the tool, even when the tool is selected.

Figure 169. Show Edge Tool Annotations

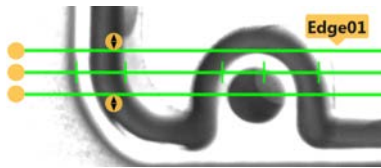
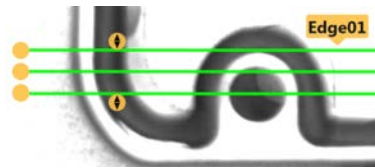

Figure 170. Hide Edge Tool Annotations



Hide ROI

Hides the ROI when the tool is **not** selected.

Tool Histogram

The Tool Histogram graphically displays pixel intensity information within the current ROI.

Figure 171. Example Histogram

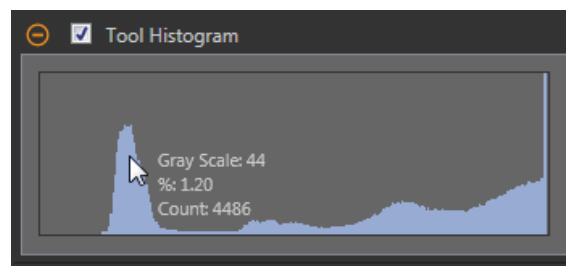

Select the **Tool Histogram** checkbox to enable the histogram. The default is enabled. Expand the **Tool Histogram** parameter to view the histogram.

The histogram is a display of the grayscale values on the x axis and the number of pixels on the y axis. The histogram displays the amount of pixels for each grayscale value. The graph displays information for all grayscale values (0 to 255). Move the pointer anywhere over the histogram to view specific information. The information updates as the position of the pointer changes.

Inspection Pass/Fail

Select the **Contribute to Inspection Pass/Fail** check box (default) if the tool will influence the Pass/Fail status of the inspection.

Figure 172. Inspection Pass/Fail

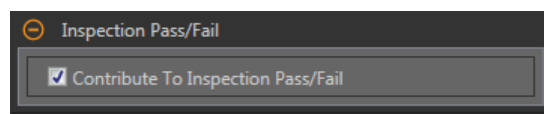

The Pass/Fail contribution influences the following:

- Discrete output Pass
- Discrete output Fail
- Pass/Fail results counter
- Pass (Green) and Fail (red) LEDs on the Sensor

Select this checkbox if the overall Pass/Fail status of the inspection is dependent on the current tool.

8.6.2 Edge Tool: Test Parameters

Use the **Test** parameters to configure the pass/fail conditions for the tool.

Select the parameter checkbox to enable it. Where applicable, the vertical green bar shows the current parameter information and the light gray backgrounds show the range over which a value has varied over time.

Where applicable, use the sliders or enter the minimum and maximum for the selected test parameters.

The current data found and the range of historical data found are shown for applicable **Test** parameters. The historical data begins from the last reset.

Figure 173. Edge Tool—Test Parameters



Total Count

The total number of edges.

Dark to Bright Count

The total number of edges that start below the threshold value and cross above the threshold value.

Bright to Dark Count

The total number of edges that start above the threshold value and cross below the threshold value.

Maximum Edge Strength

The greatest rate of change value observed by the tool.

Available when the Threshold Type is set to Edge Strength.

8.6.3 Edge Tool: Results

Tools & Results and **All Results** list information from the current and previous inspections.

A red box around a tool indicates that the tool failed. **Status** provides information about the specific failure.

All Results displays the Result, Time, Pass Count, and Fail Count information at a glance. Expand the inspection tool to see specific results for that tool.

Total Count

The total number of edges.

Expand **Total Count** to see the location of each edge.

Click an edge number/location to highlight that edge in the **Image** pane.

Dark to Bright Count

The total number of edges that start below the threshold value and cross above the threshold value.

Expand **Dark to Bright Count** to see the location of each edge.

Bright to Dark Count

The total number of edges that start above the threshold value and cross below the threshold value.

Expand **Bright to Dark Count** to see the location of each edge.

Maximum Edge Strength

The greatest rate of change value observed by the tool.

Available when the Threshold Type is set to Edge Strength.

Execution Time

The execution time, in milliseconds, for the currently selected tool in the current inspection.

Expand **Execution Time** to see the historical minimum and maximum execution times up to this point for the selected tool.

Use the reset button in the Inspection Summary to reset these historical values.

Status

Status and error messages display as appropriate.

8.6.4 Using the Edge and Measure Tools

Follow these steps for an example Edge inspection to check the position of a plunger in a syringe.

This procedure uses two Edge tools and a Measure tool to determine the position of the plunger in the barrel.



Note: This procedure is an example only.

1. Add an Edge tool to the inspection.
2. Adjust the ROI position, length, and width.
 - a) Position the ROI vertically over the top of the plunger.
 - b) Expand **ROI**, then expand **ROI Width**.
 - c) Set the ROI width to 161 px.

Figure 174. ROI Over the Top of the Plunger

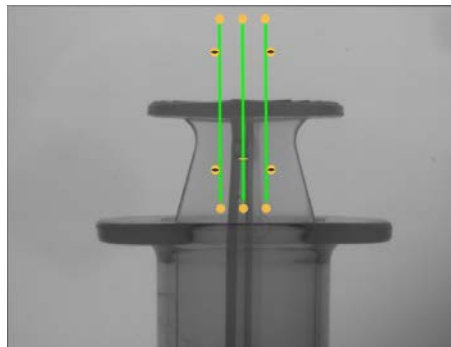

3. Set the threshold.
 - a) Expand the **Threshold** parameters.
 - b) Set the **Threshold Type** to **Edge Strength**.
 - c) Leave **Edge Strength** at the default (20).
 - d) Select **Bright to Dark** from the **Edge Polarity** list.

The tool finds the top of the plunger.

4. Add a second Edge tool.
5. Adjust the ROI position, length, and width.
 - a) Position the ROI vertically over the top of the barrel.
 - b) Expand **ROI**, then expand **ROI Width**.
 - c) Set the ROI width to 97 px.

Figure 175. ROI Over the Top of the Barrel

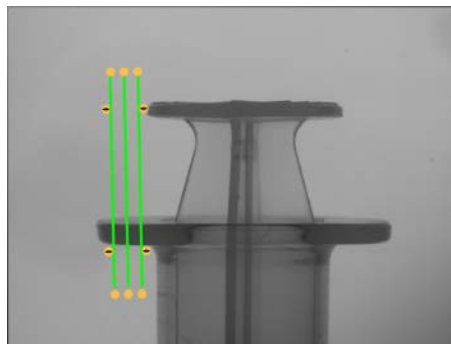

6. Set the threshold.
 - a) Expand the **Threshold** parameters.
 - b) Set the **Threshold Type** to **Edge Strength**.
 - c) Expand **Edge Strength** and set it to 21.
 - d) Select **Dark to Bright** from the **Edge Polarity** list.

The tool finds the lower edge of the barrel.

7. Add a Measure tool.
 - a) Expand **Measure From...** and select **Edge02** from the **Tool** list.
 - b) Expand **Measure To...** and select **Edge01** from the **Tool** list.

Figure 176. Measure Tool

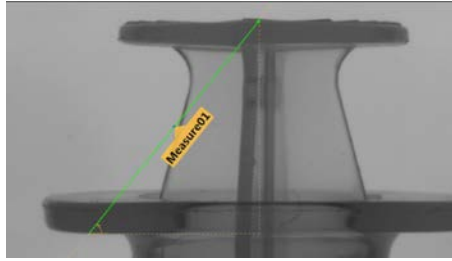

8. Set the **Test** parameters to set the pass/fail criteria.
 - a) On the **Test** tab, select the **Distance Y** checkbox to enable the test parameter.
 - b) Move the sliders slightly above and below the green line to allow for very slight variations in the distance.



Note: The green bar indicates the current distance and the light gray background indicates the distance over time.

9. Click  to show all ROIs at the same time.

Figure 177. All Tools Shown



10. Test a complete range of good and bad samples to make sure that the sensor accepts good parts and rejects bad parts.

Figure 178. Good Part

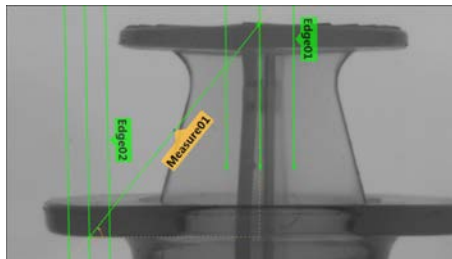
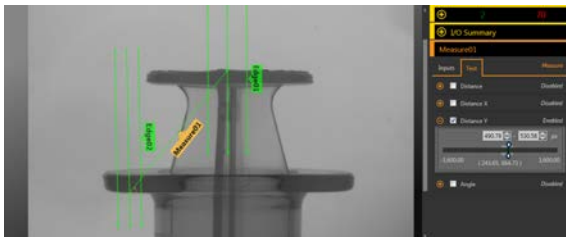
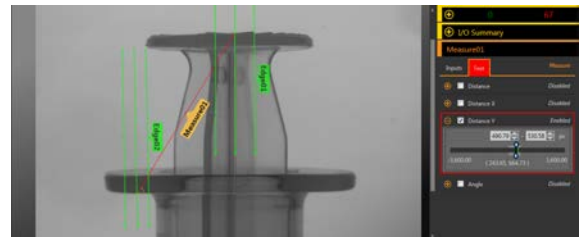

Figure 179. Bad Part—Plunger Too High



8.7 Line Detect Tool

Use the Line Detect tool to find single, straight line segments.

The Line Detect tool finds many edge points along the transitions between bright and dark pixels and then fits a line to some or all of those points. It can measure the length of a straight edge and find damage or flaws along an edge. In conjunction with a Measure tool, it can help measure between a straight line and other points or lines in the image.

Example applications:

- Measure the height and width of a part
- Measure the height of a needle
- Measure the deflection of an automotive gauge
- Detect the edge of a web

- Verify that a bottle cap is on completely
- Find chips, spurs, or other flaws along a straight edge
- Measure the angle between two lines

8.7.1 Line Detect Tool: Input Parameters

Use the **Input** parameters to configure how the tool analyzes an image.

Figure 180. Line Detect Tool—Input Parameters

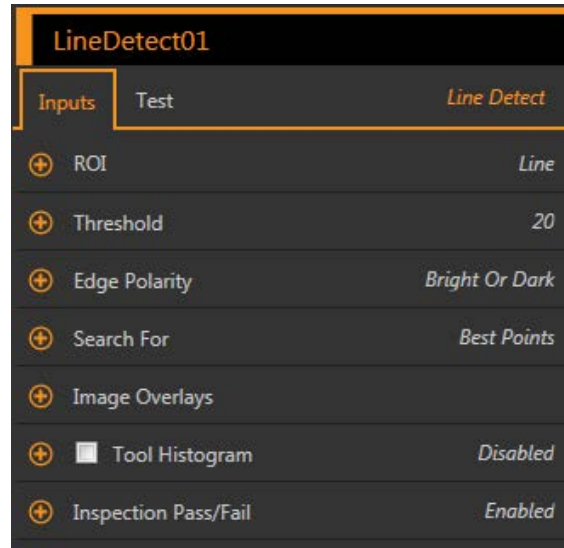

ROI

The Region of Interest (ROI) is the user-defined group of pixels in the image that the sensor analyzes.

Figure 181. Line Detect Tool ROI

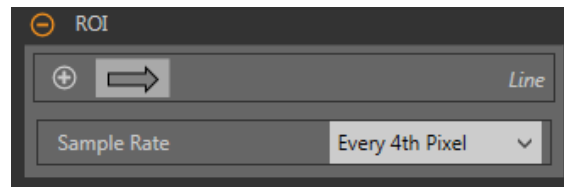

The ROI is a line of pixels that can be shortened, lengthened, or widened as needed for the inspection. Tool analysis follows the direction of the arrow. Set the width and the sample rate for the region of interest. The analysis functions best when the ROI is positioned perpendicular to the feature to be analyzed. The ROI automatically displays on the **Image** pane when a tool is added.

Adjust the placement of the ROI more precisely by using the arrow keys on the computer keyboard.

ROI Width

An ROI can be as large as the entire Field of View (FOV).

An ROI that captures as much of the line feature to be analyzed while minimizing other image content may improve consistency. Note that:

- Narrow ROIs execute faster but could miss the edge
- Wide ROIs are more consistent but don't execute as fast
- A wide ROI provides an average value/location, which results in improved repeatability

Sample Rate

The sample rate sets the spacing between scan lines along the width of the ROI (one sample for every pixel, one sample every second pixel, etc.). When the sample rate includes more pixels, more edges, more precise results, and small flaws are found. The highest sample rate is **Every Pixel**. When the sample rate includes fewer pixels, fewer, more widely spaced edges are found. The lowest sample rate is **Every 64th Pixel**. This creates a trade-off between speed and precision. Lower sample rates execute faster, and higher sample rates find more precise results and are capable of detecting smaller flaws.

Figure 182. Sample Rate Every 4th Pixel

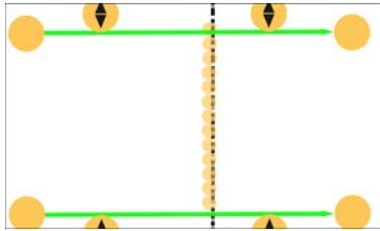
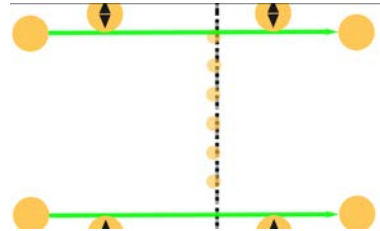

Figure 183. Sample Rate Every 8th Pixel



Threshold

Indicates the rate of change of grayscale values that is needed to detect an edge.

Figure 184. Threshold Parameters

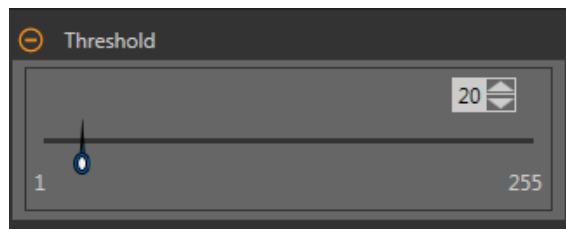

Edges are detected by measuring transitions from bright to dark or dark to bright. Enter a threshold in the range from 1 to 255. The default value is 20. As this value is reduced, the tool finds weak, blurry, or more gradual lines or edges. At lower thresholds, unwanted transitions such as background noise may become edges. Detected edges are combined to find potential line segments.

Edge Polarity

Edge Polarity defines the type of edges that the tool finds.

- Dark to Bright—Finds edges where pixel intensities start below the threshold value and cross above the threshold value
- Bright to Dark—Finds edges where pixel intensities start above the threshold value and cross below the threshold value
- Bright or Dark—Finds any edge

Search For

Set the type of points the Line Detect tool searches for.

Best Points

Automatically figures which edge points make the best line and ignores the rest. Points that are included are shown on the image in orange, while the points that are ignored are yellow. Best Points is tolerant of noise or extra edges in the ROI, but under some circumstances, it may ignore edges that should be included. If the line in the image has gaps in it, Best Points may produce lines that are shorter than desired.

All Points

Finds a line that explains all of the edges as well as possible; all found points are included in the analysis. Found points are shown on the image in orange. All Points is faster than Best Points, but works poorly if there are extra edges or noise within the ROI. All Points is useful if the line being examined is jagged, irregular, or curved.

Image Overlays

Choose whether to display or hide the ROI.

Figure 185. Image Overlays—Default

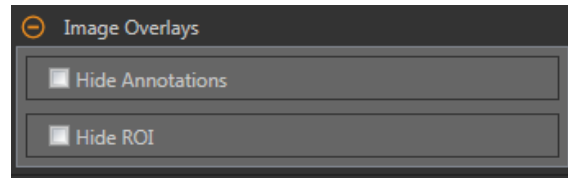

These options override the ROI view buttons  on the Image Pane Parameters when no tool is selected. When a specific tool is selected, the ROI information is shown.

Hide Annotations

Hides the annotations on the live image for the tool, even when the tool is selected.

Hide ROI

Hides the ROI when the tool is **not** selected.

Tool Histogram

The Tool Histogram graphically displays pixel intensity information within the current ROI.

Figure 186. Example Histogram

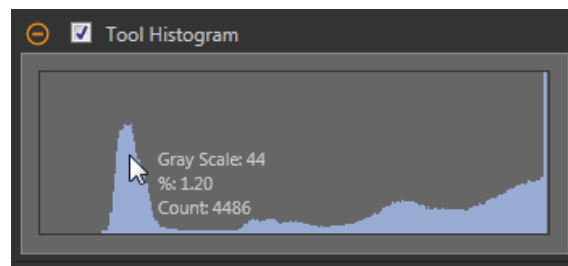

Select the **Tool Histogram** checkbox to enable the histogram. The default is enabled. Expand the **Tool Histogram** parameter to view the histogram.

The histogram is a display of the grayscale values on the x axis and the number of pixels on the y axis. The histogram displays the amount of pixels for each grayscale value. The graph displays information for all grayscale values (0 to 255). Move the pointer anywhere over the histogram to view specific information. The information updates as the position of the pointer changes.

Inspection Pass/Fail

Select the **Contribute to Inspection Pass/Fail** check box (default) if the tool will influence the Pass/Fail status of the inspection.

Figure 187. Inspection Pass/Fail

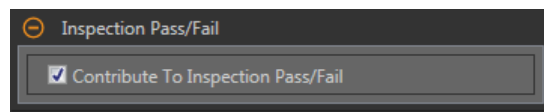

The Pass/Fail contribution influences the following:

- Discrete output Pass
- Discrete output Fail
- Pass/Fail results counter
- Pass (Green) and Fail (red) LEDs on the Sensor

Select this checkbox if the overall Pass/Fail status of the inspection is dependent on the current tool.

8.7.2 Line Detect Tool: Test Parameters

Use the **Test** parameters to configure the pass/fail conditions for the tool.

Select the parameter checkbox to enable it. Where applicable, the vertical green bar shows the current parameter information and the light gray backgrounds show the range over which a value has varied over time.

Where applicable, use the sliders or enter the minimum and maximum for the selected test parameters.

The current data found and the range of historical data found are shown for applicable **Test** parameters. The historical data begins from the last reset.

Figure 188. Line Detect Tool—Test Parameters

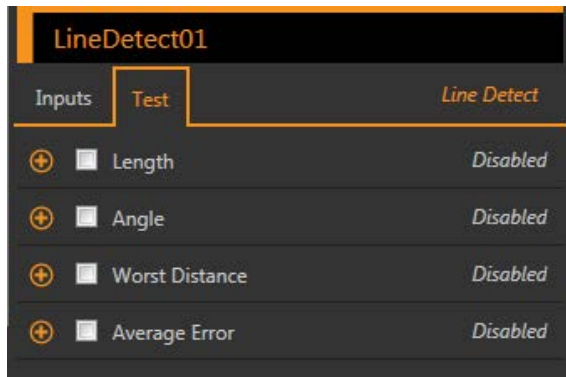

Length

The distance from the start point of the line segment to the end point.

Angle

The angle between the x-axis and the found line. The range is -180° to $+180^\circ$.

Worst Distance

The distance from the line to the farthest included edge point.

Average Error

The average distance between the included edge points and the found line. Use this value to determine whether a line is curved or irregular. This may be most useful when using the Search For All Points option.

8.7.3 Line Detect Tool: Results

Tools & Results and **All Results** list information from the current and previous inspections.

A red box around a tool indicates that the tool failed. **Status** provides information about the specific failure.

All Results displays the Result, Time, Pass Count, and Fail Count information at a glance. Expand the inspection tool to see specific results for that tool.

Midpoint

The x and y coordinates of the middle point of the found line segment.

Start Point

The x and y coordinates of the start point of the found line segment. The start point is on the end of the line segment that is closer to the top of the ROI, when viewed in the direction of the arrows.

End Point

The x and y coordinates of the end point of the found line segment.

Worst Distance Point

The x and y coordinates of the farthest included point for the found line.

Worst Distance

The distance from the line to the farthest included edge point.

Length

The distance from the start point of the line segment to the end point.

Angle

The angle between the x-axis and the found line. The range is -180° to $+180^\circ$.

Average Error

The average distance between the included edge points and the found line.

Execution Time

The execution time, in milliseconds, for the currently selected tool in the current inspection.

Expand **Execution Time** to see the historical minimum and maximum execution times up to this point for the selected tool.

Use the reset button in the Inspection Summary to reset these historical values.

Status

Status and error messages display as appropriate.

Line detect may also show another status: "Edge data may not have given a conclusive line fit." It is not an error and will not directly cause the tool to fail. If this status displays and the desired line is not consistently found, adjust the tool so that fewer edges that are not part of the desired line are found. For example, adjust the ROI to remove any unneeded area, raise the threshold value to find fewer edges, or use a specific edge polarity rather than the generic Bright Or Dark.

8.7.4 Using the Line Detect Tool

Follow these steps for a typical Line Detect inspection.

This example inspection checks whether a syringe needle is straight, bent, deformed, too short, or too long.



Note: This procedure is an example only.

1. Add a Line Detect tool to the inspection.
2. Adjust and rotate the ROI to frame the needle. The analysis functions best when the ROI is positioned perpendicular to the feature to be analyzed.
3. Set the threshold.
 - a) Expand the **Threshold** parameters.
 - b) Move the sliders until the edge of the needle is found with few extra points included.

Figure 189. Good Part

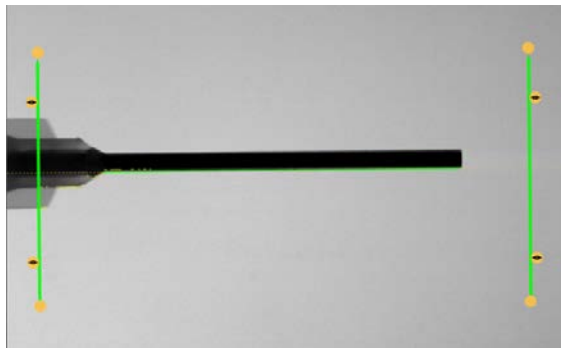

4. Set the edge polarity.
 - a) Expand the **Edge Polarity** parameters.
 - b) Select **Bright to Dark** because the needle is dark against a light background.
5. Set the **Test** parameters to set the pass/fail criteria.
 - a) On the **Test** tab, select the **Length** checkbox to enable the test parameter.
This option sets the minimum and maximum length so that a part passes.
 - b) Expand **Length** and move the sliders to set the acceptable length range.
 - c) Select the **Angle** checkbox to enable the test parameter.
This option sets the minimum and maximum angle of the part.
 - d) Move the slider or enter the angle range to ensure that only straight parts pass.
6. Test a complete range of good and bad samples to make sure that the sensor accepts good parts and rejects bad parts.

Figure 190. Bad Part—Bent Needle

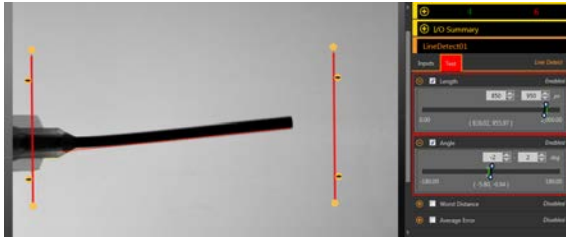
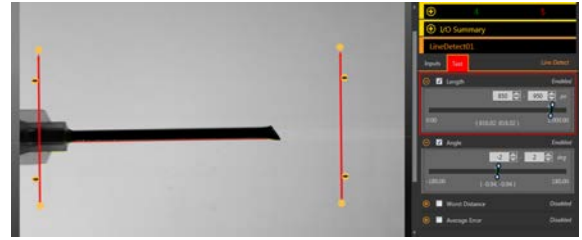

Figure 191. Bad Part—Deformed Needle



8.8 Locate Tool

Use the Locate tool to find the edge of a part and to compensate for translation and rotation (if selected).

This tool finds and marks the position of the first edge along the ROI line and aligns and positions related tools consistently over a feature of interest. When Rotation is enabled, the Locate tool calculates the angle at which the tool intersects the feature's edge and rotates the Regions of Interest (ROIs) of downstream tools accordingly.

When a Locate tool is added to an inspection, the inspection fails and there is a red box around **Use as Reference**. This is because a reference point has not yet been set. Configure the Locate tool as desired, and then set the reference point.

Example application: Adjust inspection tools for a part that moves and/or rotates in the FOV.

8.8.1 Locate Tool: Input Parameters

Use the **Input** parameters to configure how the tool analyzes an image.

Figure 192. Locate Tool—Input Parameters

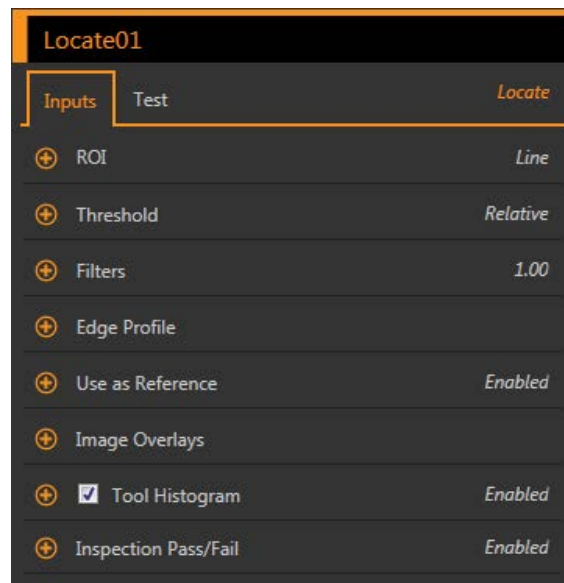

Note that the **Use as Reference** parameter appears as an error until the reference point is set.

ROI

The Region of Interest (ROI) is the user-defined group of pixels in the image that the sensor analyzes.

Figure 193. ROI Parameters

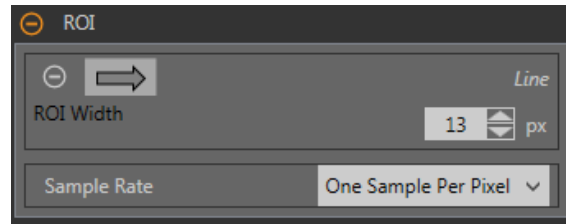

The ROI is a line of pixels that can be shortened, lengthened, or widened as needed for the inspection. Tool analysis follows the direction of the arrow. Set the width and the sample rate for the region of interest. The ROI automatically displays on the **Image** pane when a tool is added.

Adjust the placement of the ROI more precisely by using the arrow keys on the computer keyboard.

ROI Width

An ROI can be as large as the entire Field of View (FOV).

Note that:

- Narrow ROIs execute faster but could miss the edge
- Wide ROIs are more consistent but don't execute as fast
- A wide ROI provides an average value/location, which results in improved repeatability
- The ROI must be 13 pixels or wider to calculate the rotation of a part (Locate tool only)

Sample Rate

The sample rate sets the number of samples per pixels (one sample per pixel, two samples per pixel, etc.). The sample rate determines the sub-pixel resolution, which increases the resolution of the tool, and increases the inspection time.

Figure 194. 1 px Wide ROI

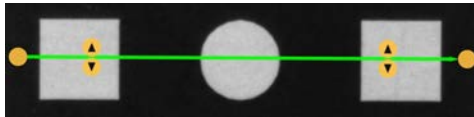
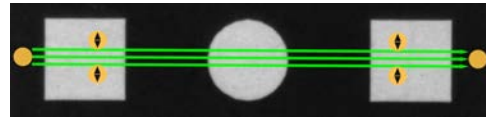

Figure 195. 13 px Wide ROI



Threshold

The Threshold parameter marks the grayscale transition point.

The tool marks the edge where the pixel intensity crosses the threshold level. From the **Threshold Type** list, select one of the following:

- Absolute
- Relative (default)
- Edge Strength

Threshold Type: Relative

Finds an edge at a relative pixel intensity. This is the default threshold setting.

Figure 196. Relative Threshold Parameters

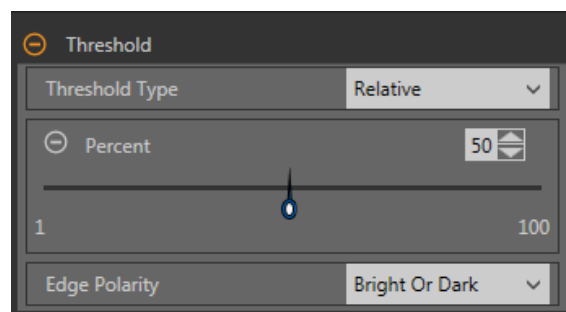

The brightest grayscale level found along the ROI is 100% and the darkest is 0%. While Relative threshold is more tolerant of light fluctuations between inspections than other transition types, it may find false edges.

Relative Threshold: Percent

Choose the percentage value at which the edge should be marked.

Edge Polarity

Edge Polarity defines the type of edges that the tool finds.

- Dark to Bright—Finds edges where pixel intensities start below the threshold value and cross above the threshold value
- Bright to Dark—Finds edges where pixel intensities start above the threshold value and cross below the threshold value
- Bright or Dark—Finds any edge

Relative Threshold: Edge Profile Graph

Figure 197. Relative Threshold—Edge Profile Graph

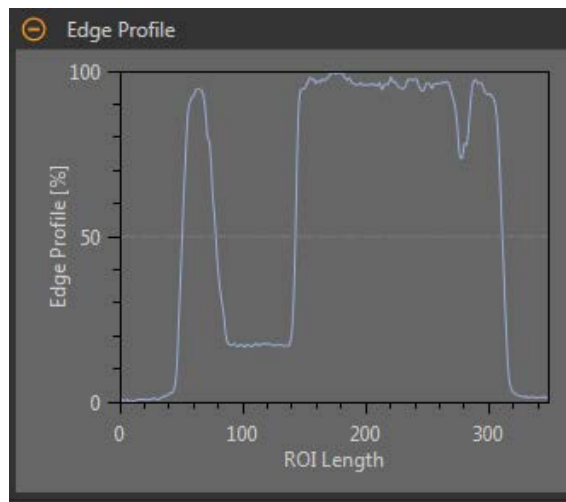

For relative threshold, the x axis is the length of the ROI. The y axis is the pixel intensity along the ROI, with 0% as the darkest pixel in the ROI and 100% as the lightest pixel in the ROI. The light blue line shows the percentage pixel intensity relative to the horizontal gray threshold line. The threshold line moves up or down with the percent value.



Note: Because the pixel intensity is relative to what is seen in the ROI, this does not necessarily mean that 0% = pure black or that 100% = pure white.

Point to a location on the graph—the corresponding location is the yellow line on the tool ROI displayed on the image.

Threshold Type: Absolute

Finds an edge at a specific grayscale level.

Figure 198. Absolute Threshold Parameters

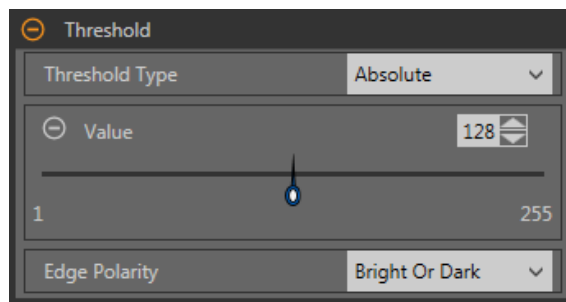

While Absolute threshold is less likely to find a false edge than Relative threshold, it may miss edges if the light level changes between inspections.

Absolute Threshold: Value

Enter a specific grayscale value from 0 to 255.

Edge Polarity

Edge Polarity defines the type of edges that the tool finds.

- Dark to Bright—Finds edges where pixel intensities start below the threshold value and cross above the threshold value
- Bright to Dark—Finds edges where pixel intensities start above the threshold value and cross below the threshold value
- Bright or Dark—Finds any edge

Absolute Threshold: Edge Profile Graph

Figure 199. Absolute Threshold—Edge Profile Graph

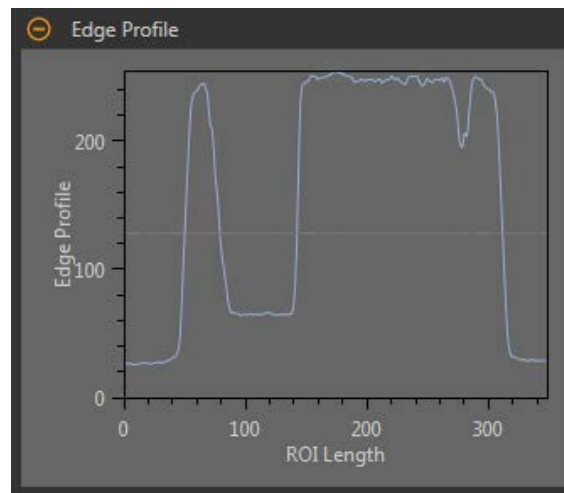

For absolute threshold, the x axis is the length of the ROI. The y axis is the actual grayscale value from 0 to 255. The light blue line shows the absolute pixel intensity. The horizontal gray threshold line moves up or down with the threshold value. Point to a location on the graph—the corresponding location is the yellow line on the tool ROI displayed on the image.

Threshold Type: Edge Strength

Measures the rate of change of grayscale values and needs sharply-defined transitions to find edges.

Figure 200. Edge Strength Threshold Parameters

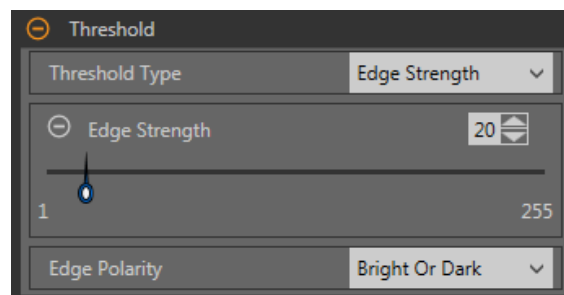

Edge strength ignores gradual changes in light levels across the tool better than other threshold types and it filters out weak or gradual edges.

Edge Strength Threshold: Edge Strength

Enter an edge strength value from 1 to 255.

Edges are selected by the edge strength method, which measures the rate of change from bright to dark or dark to bright. Enter an edge strength threshold in the range from 1 to 255. The default value is 20. As this value is reduced, the tool finds weak, blurry, or more gradual edges.

Edge Polarity

Edge Polarity defines the type of edges that the tool finds.

- Dark to Bright—Finds edges where pixel intensities start below the threshold value and cross above the threshold value
- Bright to Dark—Finds edges where pixel intensities start above the threshold value and cross below the threshold value
- Bright or Dark—Finds any edge

Edge Strength Threshold: Edge Profile Graph

Figure 201. Edge Strength Threshold—Edge Profile Graph

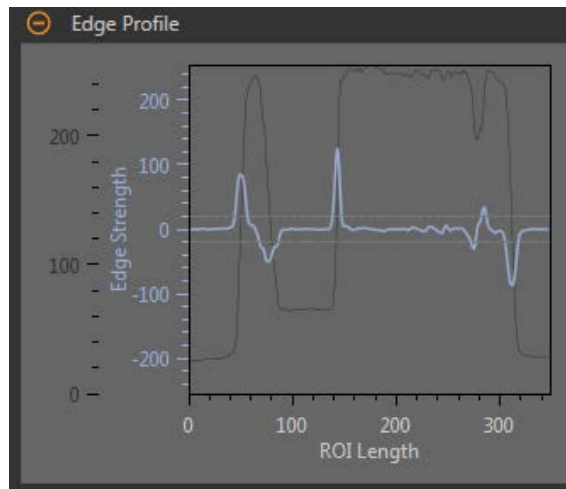

For edge strength threshold, the x axis is the length of the ROI. The y axis has two measurements. The first is the light blue axis. It represents Edge Strength, a measure of the rate of change of pixel grayscale values. The second is the dark gray axis. It represents Edge Profile, which gives the absolute grayscale level across the tool ROI. The blue line is the rate of change of the grayscale value along the ROI. The two horizontal gray lines are the edge strength threshold plus and minus. Point to a location on the graph—the corresponding location is the yellow line on the tool ROI displayed on the image.

Filters

Set filters for tool analysis.

Figure 202. Locate Tool Filters

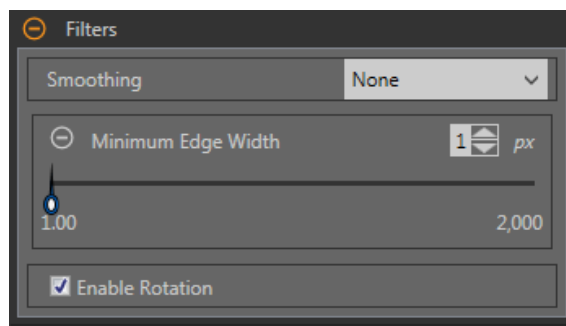

Smoothing

Runs a rolling average along the ROI length. Smoothing filters out sharp changes in the edge profile.



Note: A high filter number may miss the edge of a narrow line.

Minimum Edge Width

Filters out small spike-of-intensity changes, and narrow dark or bright bands. It determines the distance before and after an edge that must be free from additional transitions or the end of the ROI before the edge is recognized as valid.



Note: A high filter number may miss the edge of a narrow line.

Enable Rotation

Runs a rotation compensation calculation when enabled. ROIs that follow rotate according to the difference between the reference image and the current inspection image.

Edge Profile

The Edge Profile graph changes depending on which threshold type is selected. Refer to the Threshold section and the specific threshold types for details on the Edge Profile graph.

Use as Reference

Choose whether to use this tool as a reference for other tools.

Figure 203. Use As Reference—No Reference Point Set

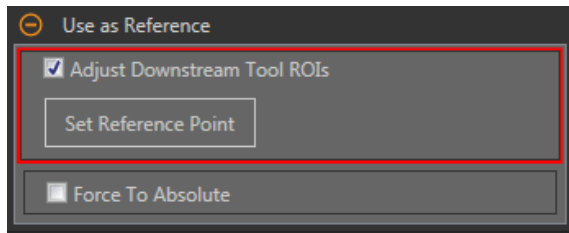
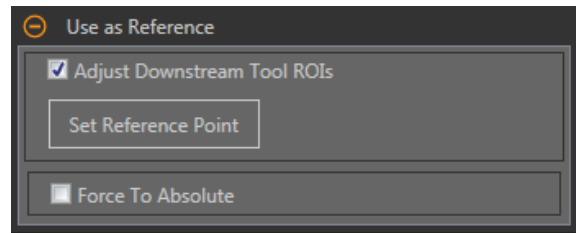

Figure 204. Use As Reference—Reference Point Set



Adjust Downstream Tool ROIs

Select **Adjust Downstream Tool ROIs** to have tools added after this tool use the this tool to set the location of the additional ROIs.

Click **Set Reference Point** button so that the tool affects the related tools, otherwise the tool and all related tools will fail. If changes are made to the tool parameters that affect the reference point, the reference point must be set again.

Force to Absolute

Select **Force to Absolute** to change this tool from relative positioning to absolute positioning.

When disabled, the tool ROI positions itself independent to any other locational tool preceding it in the inspection.

Image Overlays

Choose whether to display or hide the annotations or the ROI when this tool is **not** selected.

Figure 205. Image Overlays—Default

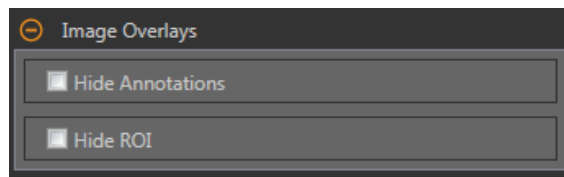

These options override the ROI view buttons  on the Image Pane Parameters when no tool is selected. When a specific tool is selected, the ROI information is shown.

Hide Annotations

Hides the annotations on the live image for the tool, even when the tool is selected.

Figure 206. Show Locate Tool Annotations

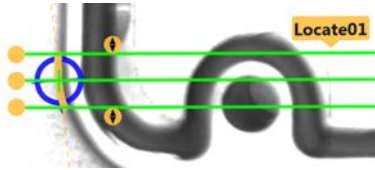
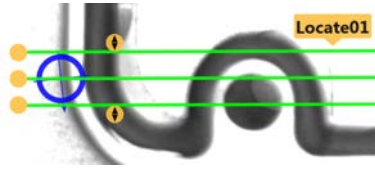

Figure 207. Hide Locate Tool Annotations



Hide ROI

Hides the ROI when the tool is **not** selected.

Tool Histogram

The Tool Histogram graphically displays pixel intensity information within the current ROI.

Figure 208. Example Histogram

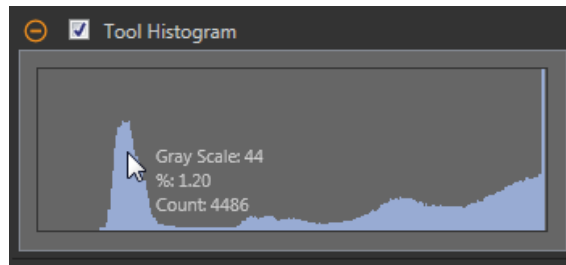

Select the **Tool Histogram** checkbox to enable the histogram. The default is enabled. Expand the **Tool Histogram** parameter to view the histogram.

The histogram is a display of the grayscale values on the x axis and the number of pixels on the y axis. The histogram displays the amount of pixels for each grayscale value. The graph displays information for all grayscale values (0 to 255). Move the pointer anywhere over the histogram to view specific information. The information updates as the position of the pointer changes.

Inspection Pass/Fail

Select the **Contribute to Inspection Pass/Fail** check box (default) if the tool will influence the Pass/Fail status of the inspection.

Figure 209. Inspection Pass/Fail

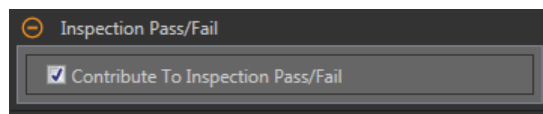

The Pass/Fail contribution influences the following:

- Discrete output Pass
- Discrete output Fail
- Pass/Fail results counter
- Pass (Green) and Fail (red) LEDs on the Sensor

Select this checkbox if the overall Pass/Fail status of the inspection is dependent on the current tool.

8.8.2 Locate Tool: Test Parameters

Use the **Test** parameters to configure the pass/fail conditions for the tool.

Select the parameter checkbox to enable it. Where applicable, the vertical green bar shows the current parameter information and the light gray backgrounds show the range over which a value has varied over time.

Where applicable, use the sliders or enter the minimum and maximum for the selected test parameters.

The current data found and the range of historical data found are shown for applicable **Test** parameters. The historical data begins from the last reset.

Figure 210. Locate Tool—Test Parameters

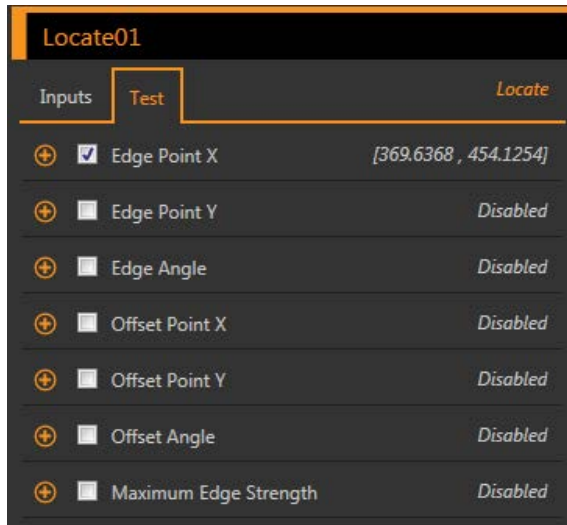
**Edge Point X**

The x coordinate of the Edge Point; the first suitable edge that the Locate tool found.

Edge Point Y

The y coordinate of the Edge Point; the first suitable edge that the Locate tool found.

Edge Angle

The angle with respect to horizontal at which the Locate tool intersects the part.

Offset Point X

The x-dimension offset between the current Edge Point and the reference point.

Available when **Adjust Downstream Tool ROIs** is enabled.

Offset Point Y

The y-dimension offset between the current Edge Point and the reference point.

Available when **Adjust Downstream Tool ROIs** is enabled.

Offset Angle

The angular difference between the current Edge Angle and the angle from the reference point.

Available when **Adjust Downstream Tool ROIs** is enabled.

Maximum Edge Strength

A measure of how much bright/dark contrast is found in the current Edge Point. A high number indicates an edge for which the grayscale value changed rapidly.

Available when the Threshold is set to Edge Strength.

8.8.3 Locate Tool: Results

Tools & Results and **All Results** list information from the current and previous inspections.

A red box around a tool indicates that the tool failed. **Status** provides information about the specific failure.

All Results displays the Result, Time, Pass Count, and Fail Count information at a glance. Expand the inspection tool to see specific results for that tool.

Edge Point

The x and y coordinates of the Edge Point; the first suitable edge the Locate tool found.

Edge Angle

The angle with respect to horizontal at which the Locate tool intersects the part.

Offset

The offset between the Edge Point and the reference point.

Expand **Offset** to see the coordinates of the Reference Point, the Reference Angle, the Offset Point, and the Offset Angle.

Maximum Edge Strength

The greatest rate of change value observed by the tool.

Available when the Threshold Type is set to Edge Strength.

Execution Time

The execution time, in milliseconds, for the currently selected tool in the current inspection.

Expand **Execution Time** to see the historical minimum and maximum execution times up to this point for the selected tool.

Use the reset button in the Inspection Summary to reset these historical values.

Status

Status and error messages display as appropriate.

8.8.4 Using the Locate Tool

Follow these steps for an example Locate inspection to adjust for a target that moves in the field of view, allowing for the precise placement of the vision tools that follow the Locate tool.

This procedure uses a Locate tool to determine the position of the vial. Using the vial position information, three Edge tools and two Measure tools determine the position of the stopper. The Locate tool is used to ensure that the Edge02 and Edge03 tools are placed correctly alongside (but not on top of) the vial, even if the vial targets move from side to side in the field of view from inspection to inspection. See [Using the Edge and Measure Tools](#) on p. 105 for details on how to set up an Edge tool and a Measure tool.



Note: This procedure is an example only.

1. Add a Locate tool to the inspection.
2. Adjust the ROI position, length, and width.
 - a) Position the ROI horizontally across the side of the vial.
 - b) Leave the **ROI Width** at the default (13 px).

Figure 211. Locate ROI

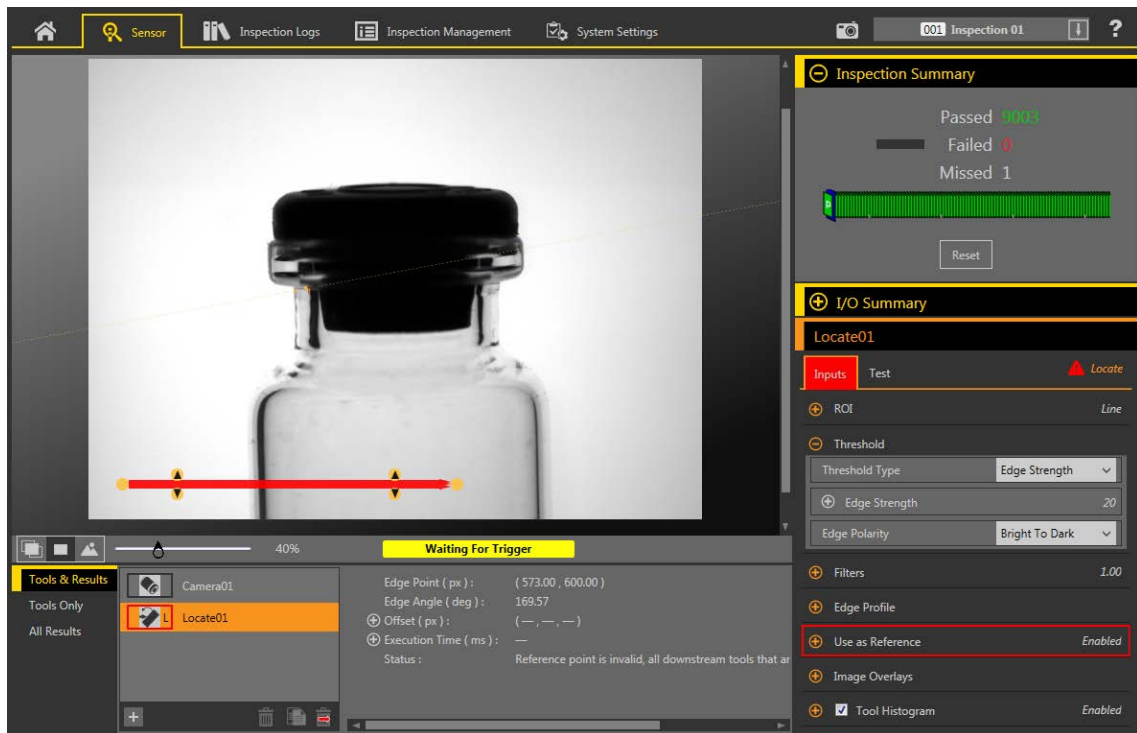

3. Find the edge that you want the tool to locate.
 - a) Expand the **Edge Profile** parameters. Use the graph as a guide for the remaining steps.
To make sure that you find the edge you want, observe how the Edge Profile graph changes as the Inputs change. Point to a location on the graph—the corresponding location is the yellow line on the tool ROI displayed on the image. The horizontal gray line is the Threshold percent.
 - b) Expand the **Threshold** parameters.
 - c) Select **Edge Strength** from the **Threshold Type** list.
 - d) Select **Bright to Dark** from the **Edge Polarity** list.
 - e) Adjust the **Edge Strength** until only the desired edge is found. In this example it is 20.
4. Expand **Filters** and set **Smoothing** to **Smooth3** to filter out sharp changes in the edge profile.
5. Set the reference point.
 - a) Expand the **Use as Reference** parameters.
 - b) Leave **Adjust Downstream Tool ROIs** checked so that it is enabled (default).
 - c) Click **Set Reference Point**.

A blue circle displays on the Image pane at the location of the reference point and all following tools use this point as a reference.

Figure 212. Reference Point

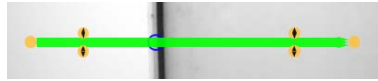

6. If the blue circle does not represent the desired reference point, repeat steps 3 to 5 and adjust the parameters until the desired reference point is found.
7. Add an Edge tool to detect the top of the stopper.

Figure 213. Edge Tool at the Top of the Stopper



8. Add an Edge tool to detect the bottom of the lip on the left side of the vial.

Figure 214. Edge Tool at the Left Side of the vial

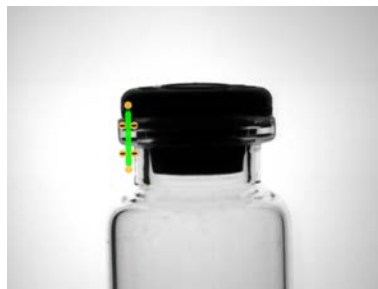

9. Add an Edge tool to detect the bottom of the lip on the right side of the vial.

Figure 215. Edge Tool at the Right Side of the vial



10. Add a Measure tool to measure from Edge02 (the left side of the vial) to Edge03 (the right side of the vial).

Figure 216. Measure Tool from Edge02 to Edge03



11. Add a Measure tool to measure from Edge01 to Measure01 to determine the position of the stopper in the vial.

Figure 217. Measure Tool from Edge01 to Measure01



12. Adjust the Measure02 **Test** parameters to set the pass/fail criteria.
 - a) On the **Test** tab, select the **Distance Y** checkbox to enable the test parameter.
 - b) Move the sliders slightly above and below the green line to allow for very slight variations in the distance.



Note: The green bar indicates the current distance and the light gray background indicates the distance over time.

13. Click  to show all ROIs at the same time.

Figure 218. All Tools Shown



14. Test a complete range of good and bad samples to make sure that the sensor accepts good parts and rejects bad parts.

Figure 219. Bad Part—Stopper Too High

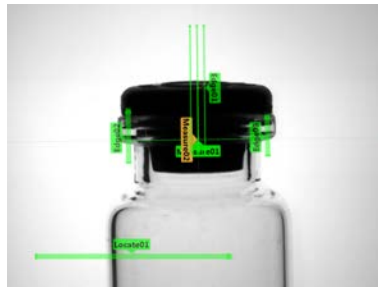

Figure 220. Bad Part—Missing Stopper



8.9 Match Tool

Use the Match tool to verify that a pattern, shape, or part in any orientation matches a reference pattern. The Match tool can also compensate for translation and rotation of downstream tools (if selected).

The reference pattern is taught during setup. A reference pattern might include alphanumeric characters, logos, or any other shapes. During an inspection, the sensor checks that each part or package being inspected matches the reference pattern. The number of expected patterns can also be determined.

When a Match tool is added to an inspection, the inspection fails and there is a red box around **Pattern**. This is because a reference pattern has not yet been taught. Configure the Teach ROI as desired, and then teach the reference pattern.

Example applications:

- Date/Lot code inspections

- Label inspections
- Part etching inspections
- Part orientation inspections
- Part shape inspections

8.9.1 Match Tool: Input Parameters

Use the **Input** parameters to configure how the tool analyzes an image.

Figure 221. Match Tool—Input Parameters

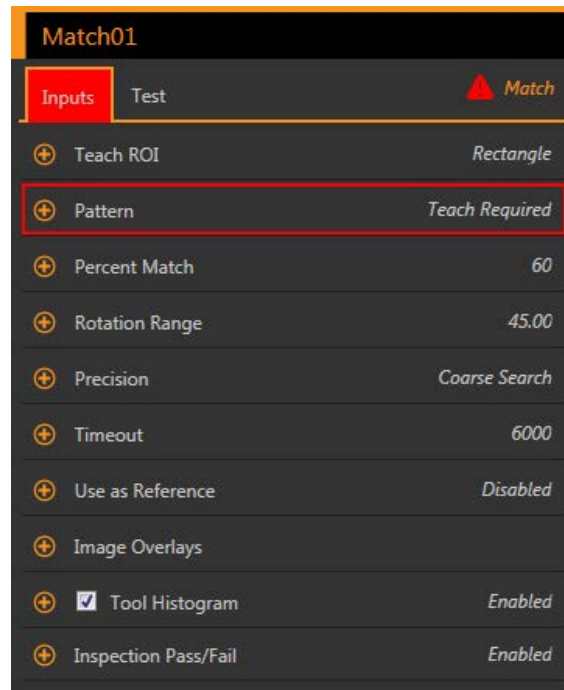

Search ROI

The Search Region of Interest (ROI) is the user-defined group of pixels in the image that the sensor analyzes.

Figure 222. Search ROI

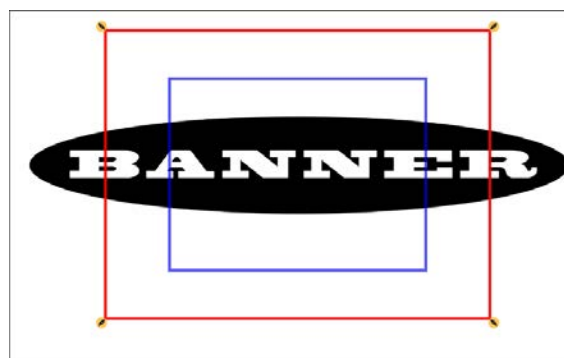

The Search ROI is indicated by a red or green box that is always rectangular. By default the Search ROI is 20% to 30% larger than the Teach ROI, which is blue. The sensor searches for the match only within the Search ROI.

Resize  the Search ROI as needed for the inspection.



Adjust the placement of the ROI more precisely by using the arrow keys on the computer keyboard.

Teach ROI

The Teach Region of Interest (ROI) is the user-defined group of pixels in the image that the sensor uses to teach a reference pattern.

Figure 223. Teach ROI



Resize  and rotate  the ROI around the feature to be used as the reference pattern. Change the shape of the ROI to a square, ellipse, or circle as needed by expanding **Teach ROI** on the **Parameters** pane and selecting the desired shape. The Teach ROI automatically displays on the **Image** pane when a Match tool is added.

Adjust the placement of the ROI more precisely by using the arrow keys on the computer keyboard.

Pattern

Displays the reference pattern that the sensor is looking for. A teach is required for the Match tool. Click **Teach** to set the match tool criteria and display the reference pattern.

Figure 224. Teach Required

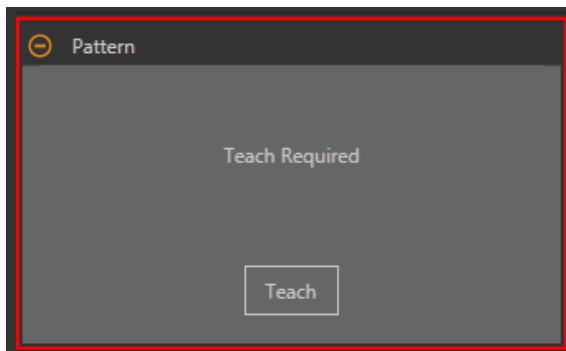
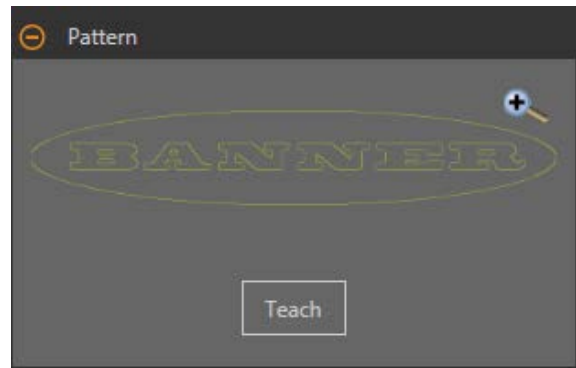

Figure 225. Pattern Taught



A red error displays until the teach is performed and the reference pattern is taught. When new patterns are added, you will need to teach the reference pattern again.

Percent Match

Set the percent match to indicate the quality of the match (10% is a slight match; 100% is a perfect match). The default is 60%.

Figure 226. Percent Match



Rotation Range

Select the range within which the pattern may be rotated and still count as a match to the reference image. The default is 45 degrees.

Figure 227. Rotation Range

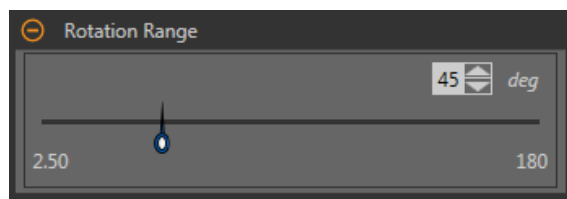

The larger the Rotation Range, the longer the execution time of the tool. In general, this means that the execution time of the inspection increases.

Precision

Select either **Fine Search** or **Coarse Search**. Course Search is the default. Fine Search is slower but provides more accurate results.

Figure 228. Precision

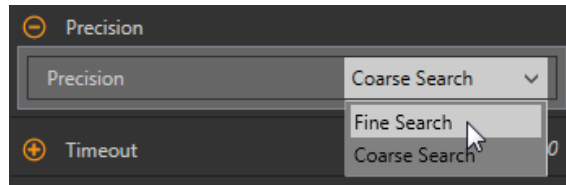

Timeout

Set the amount of time the tool executes before it stops.

Figure 229. Timeout

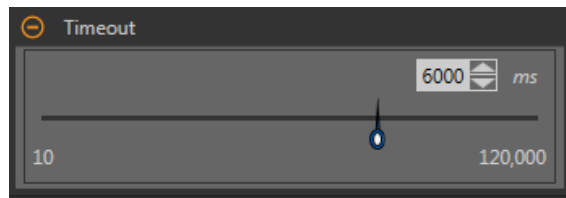

Use as Reference

Choose whether to use this tool as a reference for other tools.

Figure 230. Use As Reference—No Reference Point Set

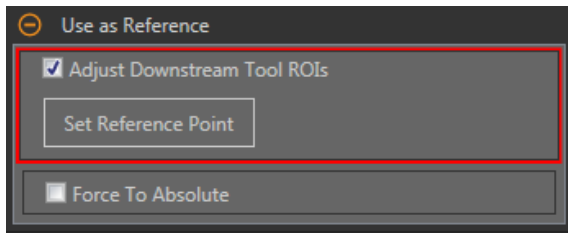
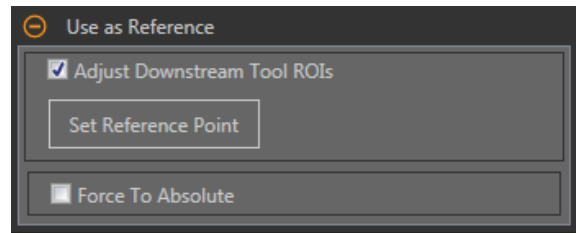

Figure 231. Use As Reference—Reference Point Set



Adjust Downstream Tool ROIs

Select **Adjust Downstream Tool ROIs** to have tools added after this tool use the this tool to set the location of the additional ROIs.

Click **Set Reference Point** button so that the tool affects the related tools, otherwise the tool and all related tools will fail. If changes are made to the tool parameters that affect the reference point, the reference point must be set again.

Force to Absolute

Select **Force to Absolute** to change this tool from relative positioning to absolute positioning.

When disabled, the tool ROI positions itself independent to any other locational tool preceding it in the inspection.

Image Overlays

Choose whether to display or hide the annotations or the ROI when this tool is **not** selected.

Figure 232. Image Overlays—Default

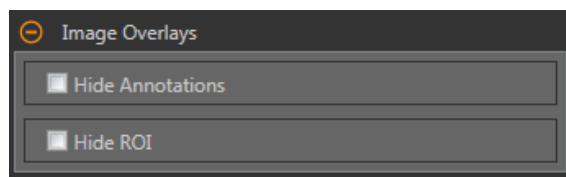

These options override the ROI view buttons  on the Image Pane Parameters when no tool is selected. When a specific tool is selected, the ROI information is shown.

Hide Annotations

Hides the annotations on the live image for the tool, even when the tool is selected.

Figure 233. Show Match Tool Annotations



Figure 234. Hide Match Tool Annotations



Hide ROI

Hides the ROI when the tool is **not** selected.

Tool Histogram

The Tool Histogram graphically displays pixel intensity information within the current ROI.

Figure 235. Example Histogram

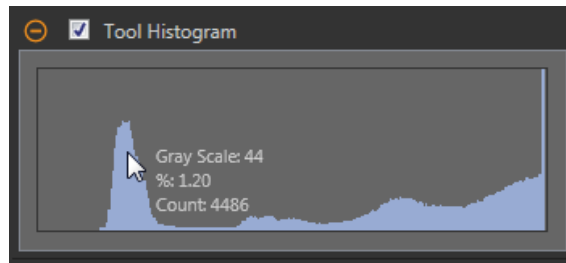

Select the **Tool Histogram** checkbox to enable the histogram. The default is enabled. Expand the **Tool Histogram** parameter to view the histogram.

The histogram is a display of the grayscale values on the x axis and the number of pixels on the y axis. The histogram displays the amount of pixels for each grayscale value. The graph displays information for all grayscale values (0 to 255). Move the pointer anywhere over the histogram to view specific information. The information updates as the position of the pointer changes.

Inspection Pass/Fail

Select the **Contribute to Inspection Pass/Fail** check box (default) if the tool will influence the Pass/Fail status of the inspection.

Figure 236. Inspection Pass/Fail

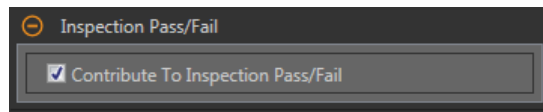

The Pass/Fail contribution influences the following:

- Discrete output Pass
- Discrete output Fail
- Pass/Fail results counter
- Pass (Green) and Fail (red) LEDs on the Sensor

Select this checkbox if the overall Pass/Fail status of the inspection is dependent on the current tool.

8.9.2 Match Tool: Test Parameters

Use the **Test** parameters to configure the pass/fail conditions for the tool.

Select the parameter checkbox to enable it. Where applicable, the vertical green bar shows the current parameter information and the light gray backgrounds show the range over which a value has varied over time.

Where applicable, use the sliders or enter the minimum and maximum for the selected test parameters.

The current data found and the range of historical data found are shown for applicable **Test** parameters. The historical data begins from the last reset.

Figure 237. Match Tool—Test Parameters

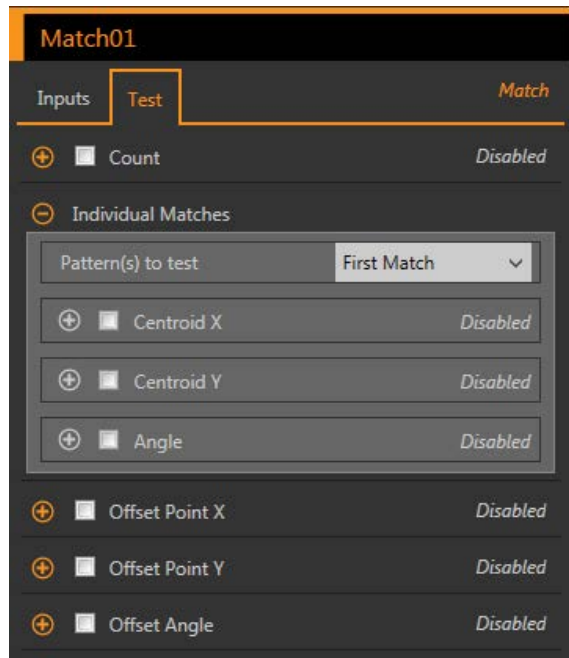

Count

The number of matching patterns.

Individual Matches

Specific Match—Select **First Match** or **Specific Match**.

Centroid X—The location of the point of the center of mass of the selected match on the x axis.

Centroid Y—The location of the point of the center of mass of the selected match on the y axis.

Angle—The rotated angle of the matching object.

Offset Point X

The x-dimension offset between the current match and the reference point.

Available when **Adjust Downstream Tool ROIs** is enabled.

Offset Point Y

The y-dimension offset between the current match and the reference point.

Available when **Adjust Downstream Tool ROIs** is enabled.

Offset Angle

The angular difference between the current angle and the angle from the reference point.

Available when **Adjust Downstream Tool ROIs** is enabled.

8.9.3 Match Tool: Results

Tools & Results and **All Results** list information from the current and previous inspections.

A red box around a tool indicates that the tool failed. **Status** provides information about the specific failure.

All Results displays the Result, Time, Pass Count, and Fail Count information at a glance. Expand the inspection tool to see specific results for that tool.

Count

The number of matching patterns.

Percentage Range

The percentage by which the found objects match the reference object. Expand **Percentage Range** to view the centroid (center point), angle, and percent match for the objects found within the ROI.

Offset

The offset between the match and the reference point.

Available when **Adjust Downstream Tool ROIs** is enabled.

Expand **Offset** to see the coordinates of the Reference Point, the Reference Angle, the Offset Point, and the Offset Angle.

Execution Time

The execution time, in milliseconds, for the currently selected tool in the current inspection.

Expand **Execution Time** to see the historical minimum and maximum execution times up to this point for the selected tool.

Use the reset button in the Inspection Summary to reset these historical values.

Status

Status and error messages display as appropriate.

8.9.4 Using the Match Tool

Follow these steps for an example Match inspection. The Match tool requires a reference pattern that is taught during set up. The Match tool uses two ROIs. The larger, green/red ROI is the Search ROI and defines the area that the sensor searches for the desired feature. This ROI cannot be rotated and it is always a square. The smaller, blue ROI is the Teach ROI. This ROI is used to define the feature that the sensor is looking for.

Before using the Match tool, teach the desired feature (reference pattern). While setting up a Match tool, it can be helpful to slow the trigger rate or to set the trigger to external.



Note: If the trigger is set to internal, there is a lag between when the TEACH occurs and when Vision Manager uses the taught feature to inspect the part(s). The time to teach the sensor is not included in the inspection time on **Tools & Results** or **All Results**.



Note: This procedure is an example only.

1. Add a Match tool to the inspection.

The inspection fails and a warning displays until the reference pattern is taught.

Figure 238. Match Tool Defaults

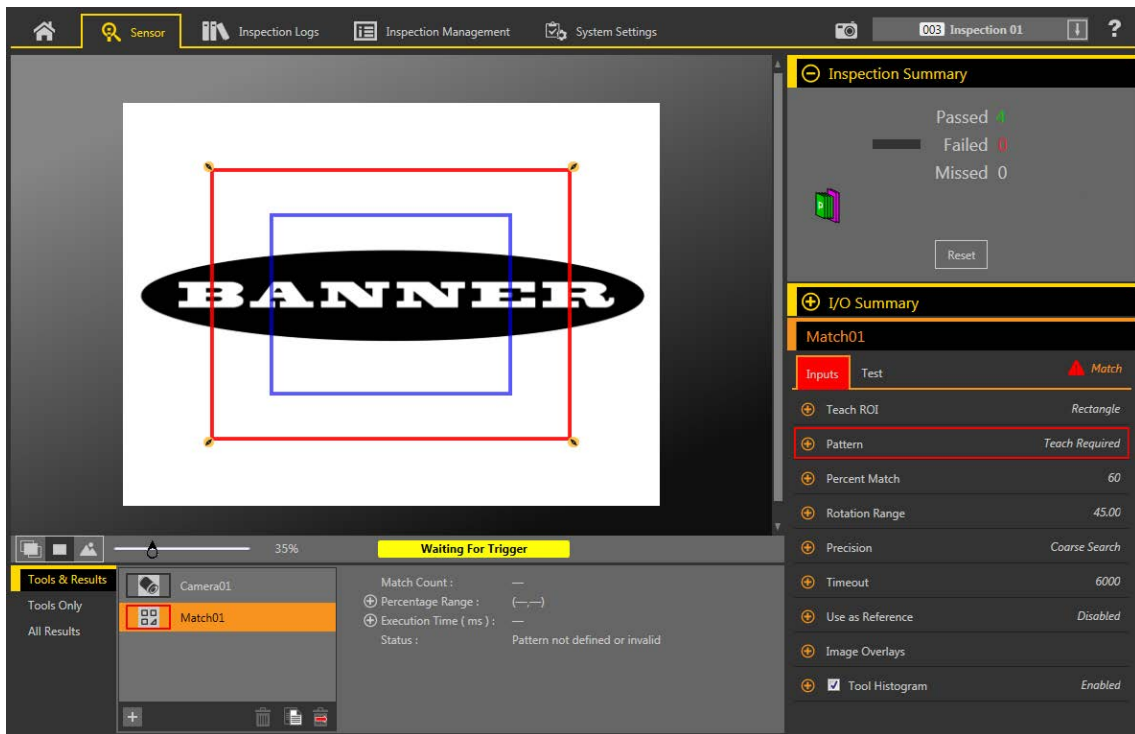

2. Adjust the Teach ROI to frame the feature to be used as the reference pattern. In this example, the feature of interest is the Banner logo.
 - a) Expand **Teach ROI** and select the ellipse.
 - b) Resize and rotate the ROI around the feature.
3. On the **Parameters** pane, expand **Pattern** and click **Teach**.

Figure 239. Teach Required

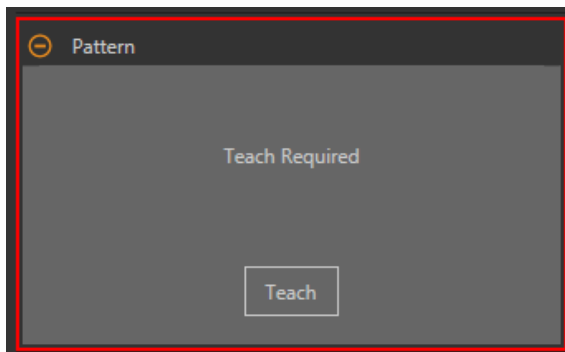
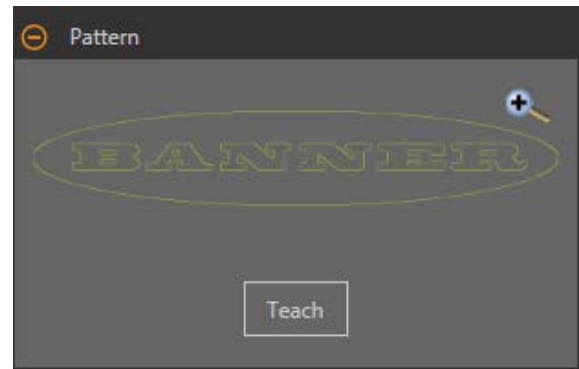

Figure 240. Pattern Taught



Note: If the inspection uses more than one Match tool, teach only one Match tool at a time.

"Applying Changes" displays, then the reference pattern displays in the **Pattern** pane, and **Tools & Results** and **All Results** display one match.

4. If necessary, repeat steps 2 and 3 to teach the feature again.
5. Adjust the Search ROI to fill the FOV.

Figure 241. Teach and Search ROIs Configured



6. Expand **Percent Match** and set it to 99.
The found pattern must closely match the taught reference pattern.
7. Expand **Rotation Range** and set it to 90.
The found pattern can rotate by 90 degrees and still pass.



Note: Rotation Range and Percent Match work together. The higher the Percent Match, the lower the Rotation Range to pass. In this example a 99% match fails a missing letter but passes a match that is rotated 45 degrees.

8. On the **Test** tab, select the **Count** checkbox to enable the **Count** test parameter.
9. Expand **Count** and set it to a minimum of 1 and a maximum of 1.
One and only one matching pattern must be found for the inspection to pass.
10. Test a complete range of good and bad samples to make sure that the sensor accepts good parts and rejects bad parts.

Figure 242. Rotated Good Part

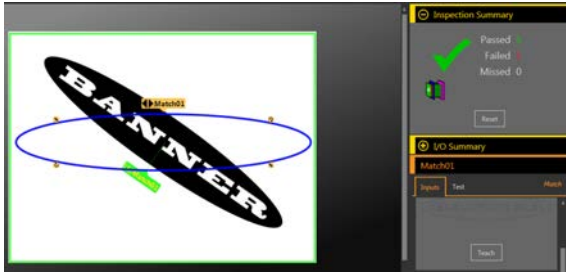

Figure 243. Bad Part—Missing Letter



8.9.5 Using Remote TEACH with the Match Tool

If multiple Match tools are used in the same inspection, remote TEACH teaches all Match tools at the same time using the same trigger.

The time to teach is included in the inspection time on **Tools & Results** and **All Results**.

1. Set up the inspection and Match tool(s) as desired.
2. In Vision Manager, make sure that one of the five user-defined I/O is set to **Remote Teach**.
3. Toggle the Remote Teach input. The next valid trigger input causes the Remote Teach to occur. This is when the new Match patterns are learned.



8.10 Object Tool

Use the Object tool to detect and measure the length of dark and bright segments in an ROI.

The Object tool measures the widths of every dark and light segment along the ROI, calculates the midpoint for every segment, and counts the total number of segments. The midpoint location can be used as an input to the Measure tool. Each segment can have a unique size limit, or all segments may have the same size limit.

Example applications:

- Measure the width of a label
- Locate the center of a box on a conveyor
- Measure the gaps between stamped metal parts

8.10.1 Object Tool: Input Parameters

Use the **Input** parameters to configure how the tool analyzes an image.

Figure 244. Object Tool—Input Parameters



ROI

The Region of Interest (ROI) is the user-defined group of pixels in the image that the sensor analyzes.

Figure 245. ROI Parameters

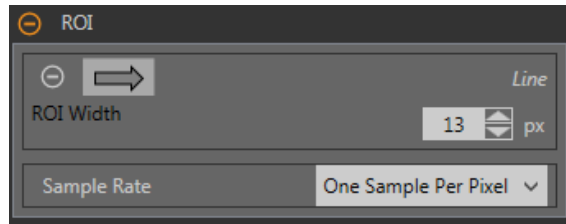

The ROI is a line of pixels that can be shortened, lengthened, or widened as needed for the inspection. Tool analysis follows the direction of the arrow. Set the width and the sample rate for the region of interest. The ROI automatically displays on the **Image** pane when a tool is added.

Adjust the placement of the ROI more precisely by using the arrow keys on the computer keyboard.

ROI Width

An ROI can be as large as the entire Field of View (FOV).

Note that:

- Narrow ROIs execute faster but could miss the edge
- Wide ROIs are more consistent but don't execute as fast
- A wide ROI provides an average value/location, which results in improved repeatability
- The ROI must be 13 pixels or wider to calculate the rotation of a part (Locate tool only)

Sample Rate

The sample rate sets the number of samples per pixels (one sample per pixel, two samples per pixel, etc.). The sample rate determines the sub-pixel resolution, which increases the resolution of the tool, and increases the inspection time.

Figure 246. 1 px Wide ROI

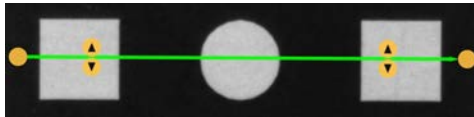
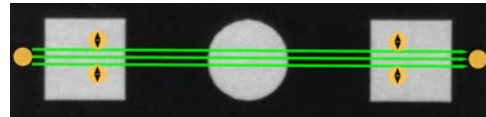

Figure 247. 13 px Wide ROI



Threshold

The Threshold parameter marks the grayscale transition point.

The tool marks the edge where the pixel intensity crosses the threshold level. From the **Threshold Type** list, select one of the following:

- Absolute
- Relative (default)
- Edge Strength

Threshold Type: Relative

Finds an edge at a relative pixel intensity. This is the default threshold setting.

Figure 248. Relative Threshold Parameters

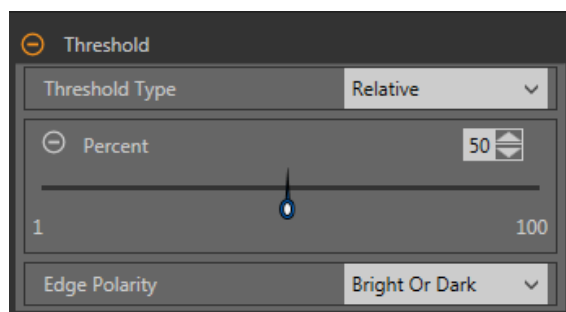

The brightest grayscale level found along the ROI is 100% and the darkest is 0%. While Relative threshold is more tolerant of light fluctuations between inspections than other transition types, it may find false edges.

Relative Threshold: Percent

Choose the percentage value at which the edge should be marked.

Object Type

Select the type of object the inspection is looking for.

- **Bright**—Finds objects brighter than the threshold value
- **Dark**—Finds objects darker than the threshold value
- **Bright or Dark**—Finds any object

Relative Threshold: Edge Profile Graph

Figure 249. Relative Threshold—Edge Profile Graph

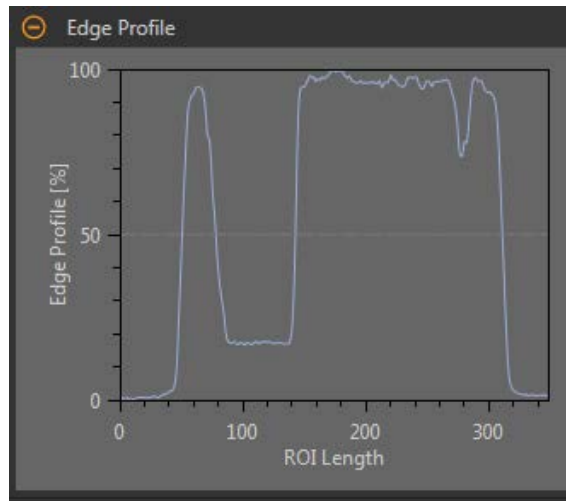

For relative threshold, the x axis is the length of the ROI. The y axis is the pixel intensity along the ROI, with 0% as the darkest pixel in the ROI and 100% as the lightest pixel in the ROI. The light blue line shows the percentage pixel intensity relative to the horizontal gray threshold line. The threshold line moves up or down with the percent value.



Note: Because the pixel intensity is relative to what is seen in the ROI, this does not necessarily mean that 0% = pure black or that 100% = pure white.

Point to a location on the graph—the corresponding location is the yellow line on the tool ROI displayed on the image.

Threshold Type: Absolute

Finds an edge at a specific grayscale level.

Figure 250. Absolute Threshold Parameters

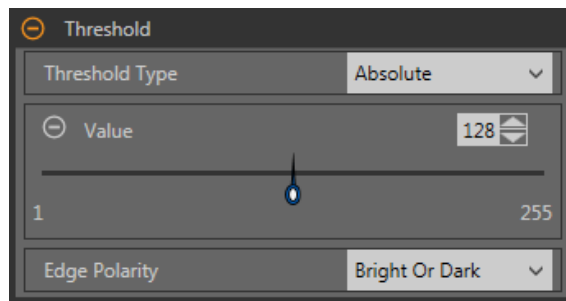

While Absolute threshold is less likely to find a false edge than Relative threshold, it may miss edges if the light level changes between inspections.

Absolute Threshold: Value

Enter a specific grayscale value from 0 to 255.

Object Type

Select the type of object the inspection is looking for.

- **Bright**—Finds objects brighter than the threshold value
- **Dark**—Finds objects darker than the threshold value
- **Bright or Dark**—Finds any object

Absolute Threshold: Edge Profile Graph

Figure 251. Absolute Threshold—Edge Profile Graph

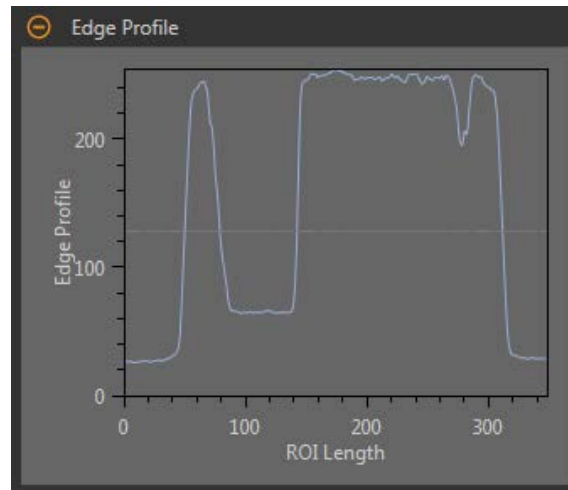

For absolute threshold, the x axis is the length of the ROI. The y axis is the actual grayscale value from 0 to 255. The light blue line shows the absolute pixel intensity. The horizontal gray threshold line moves up or down with the threshold value. Point to a location on the graph—the corresponding location is the yellow line on the tool ROI displayed on the image.

Threshold Type: Edge Strength

Measures the rate of change of grayscale values and needs sharply-defined transitions to find edges.

Figure 252. Edge Strength Threshold Parameters

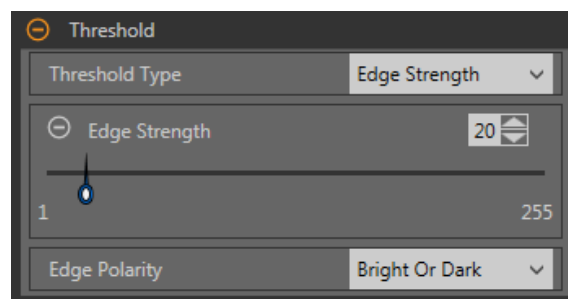

Edge strength ignores gradual changes in light levels across the tool better than other threshold types and it filters out weak or gradual edges.

Edge Strength Threshold: Edge Strength

Enter an edge strength value from 1 to 255.

Edges are selected by the edge strength method, which measures the rate of change from bright to dark or dark to bright. Enter an edge strength threshold in the range from 1 to 255. The default value is 20. As this value is reduced, the tool finds weak, blurry, or more gradual edges.

Object Type

Select the type of object the inspection is looking for.

- **Bright**—Finds objects brighter than the threshold value
- **Dark**—Finds objects darker than the threshold value
- **Bright or Dark**—Finds any object

Edge Strength Threshold: Edge Profile Graph

Figure 253. Edge Strength Threshold—Edge Profile Graph

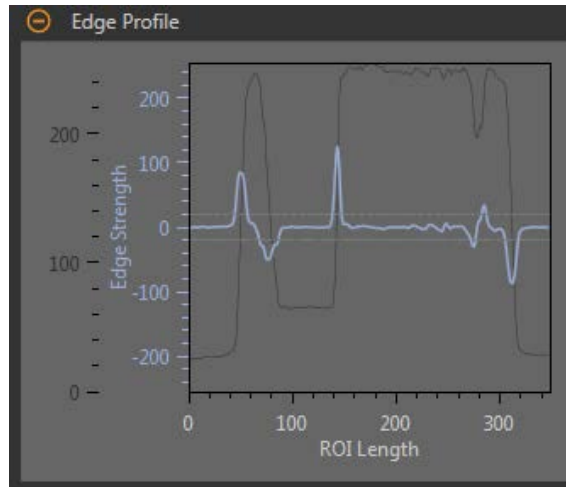

For edge strength threshold, the x axis is the length of the ROI. The y axis has two measurements. The first is the light blue axis. It represents Edge Strength, a measure of the rate of change of pixel grayscale values. The second is the dark gray axis. It represents Edge Profile, which gives the absolute grayscale level across the tool ROI. The blue line is the rate of change of the grayscale value along the ROI. The two horizontal gray lines are the edge strength threshold plus and minus. Point to a location on the graph—the corresponding location is the yellow line on the tool ROI displayed on the image.

Filters

Set filters for tool analysis.

Figure 254. Object Tool Filters

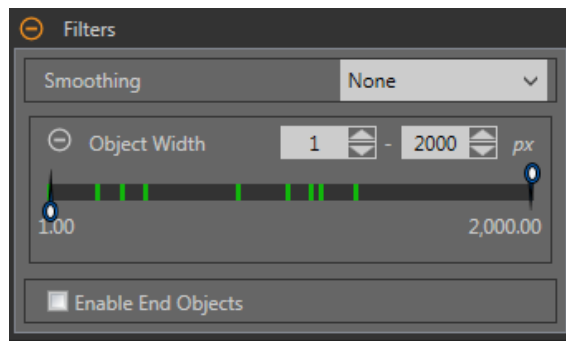

Smoothing

Runs a rolling average along the ROI length. Smoothing filters out sharp changes in the edge profile.

Object Width

Filters out objects and spaces that are smaller than the minimum and larger than the maximum values specified.

Enable End Objects

When enabled, pixels that touch the ends of the ROI are ignored. This may ignore one or more objects.

Edge Profile

The Edge Profile graph changes depending on which threshold type is selected. Refer to the Threshold section and the specific threshold types for details on the Edge Profile graph.

Image Overlays

Choose whether to display or hide the annotations or the ROI when this tool is **not** selected.

Figure 255. Image Overlays—Default

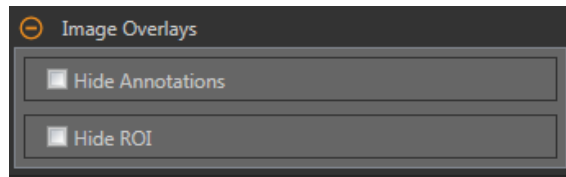

These options override the ROI view buttons  on the Image Pane Parameters when no tool is selected. When a specific tool is selected, the ROI information is shown.

Hide Annotations

Hides the annotations on the live image for the tool, even when the tool is selected.

Figure 256. Show Object Tool Annotations



Figure 257. Hide Object Tool Annotations

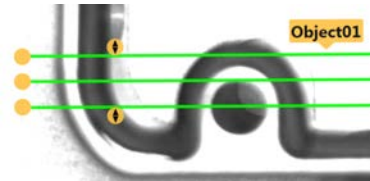

Hide ROI

Hides the ROI when the tool is **not** selected.

Tool Histogram

The Tool Histogram graphically displays pixel intensity information within the current ROI.

Figure 258. Example Histogram

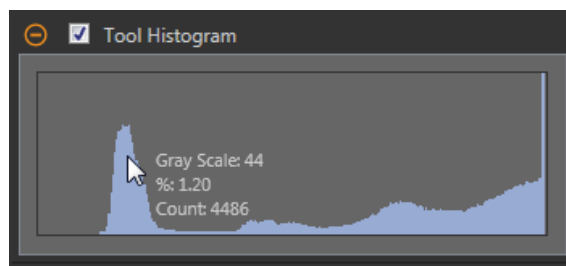

Select the **Tool Histogram** checkbox to enable the histogram. The default is enabled. Expand the **Tool Histogram** parameter to view the histogram.

The histogram is a display of the grayscale values on the x axis and the number of pixels on the y axis. The histogram displays the amount of pixels for each grayscale value. The graph displays information for all grayscale values (0 to 255). Move the pointer anywhere over the histogram to view specific information. The information updates as the position of the pointer changes.

Inspection Pass/Fail

Select the **Contribute to Inspection Pass/Fail** check box (default) if the tool will influence the Pass/Fail status of the inspection.

Figure 259. Inspection Pass/Fail

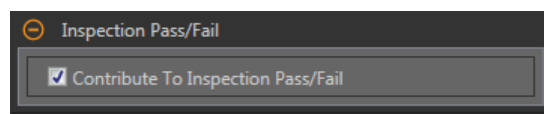

The Pass/Fail contribution influences the following:

- Discrete output Pass
- Discrete output Fail
- Pass/Fail results counter
- Pass (Green) and Fail (red) LEDs on the Sensor

Select this checkbox if the overall Pass/Fail status of the inspection is dependent on the current tool.

8.10.2 Object Tool: Test Parameters

Use the **Test** parameters to configure the pass/fail conditions for the tool.

Select the parameter checkbox to enable it. Where applicable, the vertical green bar shows the current parameter information and the light gray backgrounds show the range over which a value has varied over time.

Where applicable, use the sliders or enter the minimum and maximum for the selected test parameters.

The current data found and the range of historical data found are shown for applicable **Test** parameters. The historical data begins from the last reset.

Figure 260. Object Tool—Test Parameters

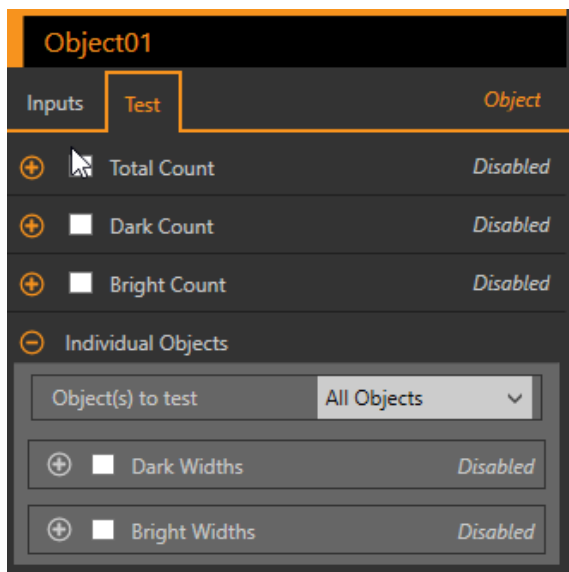

Total Count

The total number of bright, dark, or all objects, depending on the bright/dark option in effect.

Dark Count

The number of dark objects.

Bright Count

The number of bright objects.

Maximum Edge Strength

The greatest rate of change value observed by the tool.

Available when the Threshold Type is set to Edge Strength.

Individual Objects

Object(s) to test—Select All Objects, First Object, or Specific Object.

Dark Widths—Select the range of dark widths to count.

Bright Widths—Select the range of bright widths to count.

8.10.3 Object Tool: Results

Tools & Results and **All Results** list information from the current and previous inspections.

A red box around a tool indicates that the tool failed. **Status** provides information about the specific failure.

All Results displays the Result, Time, Pass Count, and Fail Count information at a glance. Expand the inspection tool to see specific results for that tool.

Total Count

The total number of bright, dark, or all objects, depending on the bright/dark option in effect.

Dark Count

The number of dark objects.

Bright Count

The number of bright objects.

Widths

Expand **Widths** to view the widths and location of the objects found, sorted by order of occurrence along the **Object** tool path

Click a number/width/location to highlight that width on the **Image** pane.

Maximum Edge Strength

The greatest rate of change value observed by the tool.
Available when the Threshold Type is set to Edge Strength.

Execution Time

The execution time, in milliseconds, for the currently selected tool in the current inspection.
Expand **Execution Time** to see the historical minimum and maximum execution times up to this point for the selected tool.

Use the reset button in the Inspection Summary to reset these historical values.

Status

Status and error messages display as appropriate.

8.10.4 Using the Object Tool

Follow these steps for an example Object inspection.

This example verifies the number and position of pins on a connector by analyzing the size of the two gaps between the pins.



Note: This procedure is an example only.

1. Add an Object tool to the inspection.
2. Adjust the position, length, and width of the ROI.
 - a) Move the ROI so that it crosses all of the pins.
 - b) Leave the default ROI width (13 px).

Figure 261. Object Tool

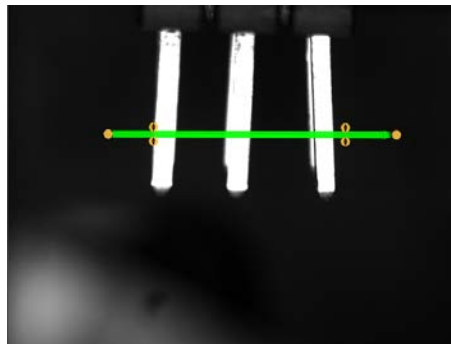

3. Set the threshold.
 - a) Expand the **Threshold** parameters.
 - b) Leave the **Threshold Type** as the default (Relative).
 - c) Leave the **Percent** as the default (50).
 - d) Select **Dark** from the **Object Type** list.
4. Set the **Test** parameters to set the pass/fail criteria.
 - a) Expand **Individual Objects**.
 - b) Select the **All Dark Width Range** checkbox to enable the parameter.
 - c) Move the sliders or enter the minimum as 141.48 and the maximum as 252.96.
5. Test a complete range of good and bad samples to make sure that the sensor accepts good parts and rejects bad parts.

Figure 262. Good Part

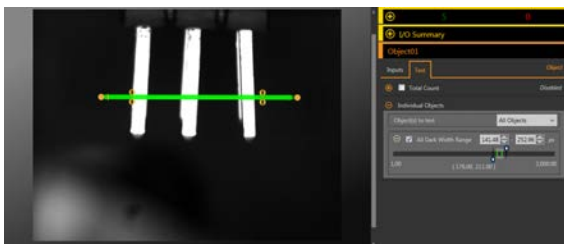

Figure 263. Bad Part—Bent Pin



9 Using the Inspection Tools: ID Tools

ID Tools identify encoded data in an image, such as a barcode. ID Tools are only available on VE ID or VE Vision + ID models.

Click a tool on **Tools & Results** or on **Tools Only** to access the **Parameters** pane for that tool. The **Parameters** pane contains both an **Inputs** tab and a **Test** tab. Define parameters for the tool itself on the **Inputs** tab. Define pass or fail criteria for the tool on the **Test** tab. When a tool is selected, the tool is highlighted orange in **Tools & Results** and in **Tools Only**, the tool ROI is selected in the **Image** pane, and the tool results are highlighted in **All Results**.

For many of the parameters, move the slider to set the desired number, or move both sliders to set minimum and maximum limits, where applicable. Numbers and limits can also be entered manually.



9.1 Barcode Tool

Use the Barcode tool to find and read Data Matrix, QR, PDF-417, Linear, and Postal barcode types in user-selectable decoder modes, color schemes, and viewer schemes.

9.1.1 ROI

The Region of Interest (ROI) is the user-defined group of pixels in the image that the sensor analyzes.











The ROI is added when a tool is added. The Barcode ROI is always rectangular, and can be reduced in size to reduce execution time. The default Barcode ROI covers the entire field of view (FOV). Any barcode must be entirely contained within the ROI in order to be read. Resize  the ROI to include the entire area in which to search for barcodes. An ROI can be as large as the entire Field of View (FOV). The ROI automatically displays on the **Image** pane when a tool is added.

Adjust the placement of the ROI more precisely by using the arrow keys on the computer keyboard.

9.1.2 Barcode Tool: Input Parameters

Use the **Input** parameters to configure how the tool analyzes an image.

Figure 264. Barcode Tool—Input Parameters

Barcode01	
Inputs	Test
 Auto Learn	
 Max Barcode Count	1
 1D Barcodes	Multiple
 2D Barcodes	Multiple
 Postal Barcodes	None
 Quality Grading	Disabled
 Timeout	4000
 Image Overlays	
 <input type="checkbox"/> Tool Histogram	Disabled
 Inspection Pass/Fail	Enabled

Auto Learn

Use **Auto Learn** to find barcodes in the image.

Figure 265. Auto Learn

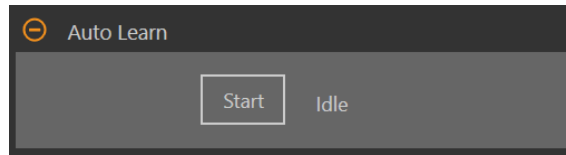

A search runs to find up to 10 barcodes in the image. Then the Max Barcode Count is set to the number of found barcodes. Any barcodes found are listed in the **Auto Learn** results window. Any barcode symbologies that are not found are disabled. All other Input parameter selections are reset, except for the size and placement of the ROI.

Figure 266. Barcodes Found

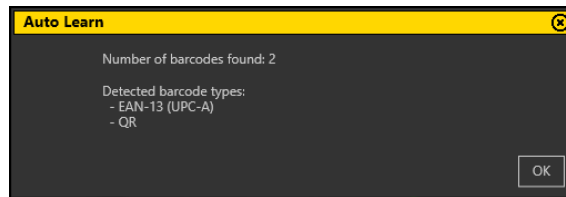

Note: Auto Learn does not read Data Matrix: Dot Peen Mode or Pharmacode barcodes.

Max Barcode Count

Set the maximum number of barcodes to be read by the Barcode tool.

Decrease this value to reduce the execution time by ending the search for barcodes when the maximum number has been met.

Figure 267. Max Barcode Count

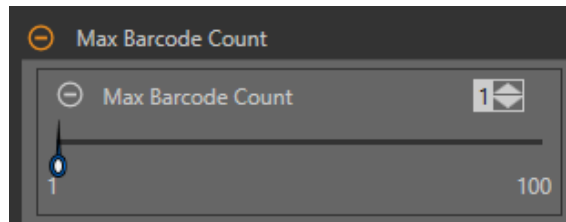

1D Barcodes

The first time the barcode tool is added, Data Matrix, QR Code, and many 1D barcode types are selected. Select the desired barcode types to be read. As a best practice, select only the applicable barcode type(s) for your particular application to optimize performance.

Figure 268. 1D Barcodes

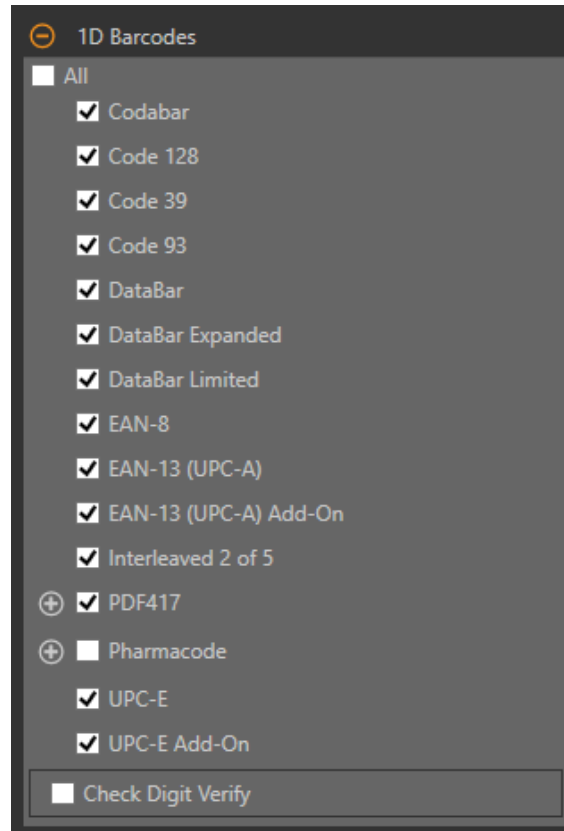
**All**

Select to enable the tool to search for all types of 1D barcodes.

Codabar

Select so that the tool reads the Codabar barcode type.

Code 128

Select so that the tool reads the Code 128 barcode type.

Code 39

Select so that the tool reads the Code 39 barcode type.

Code 93

Select so that the tool reads the Code 93 barcode type.

DataBar

Select so that the tool reads the DataBar barcode type.

DataBar Expanded

Select so that the tool reads the DataBar Expanded barcode type.

DataBar Limited

Select so that the tool reads the DataBar Limited barcode type.

EAN-8

Select so that the tool reads the EAN-8 barcode type.

EAN-13 (UPC-A)

Select so that the tool reads the EAN-13 (UPC-A) barcode type.

EAN-13 (UPC-A) Add-On

Select so that the tool reads the EAN-13 (UPC-A) Add-On barcode type.

Interleaved 2 of 5

Select so that the tool reads the Interleaved 2 of 5 barcode type.

PDF417

Decoder Mode determines which decode algorithm to use and how imperfections in barcode images are handled.

- **Robust**—The tool uses an algorithm that performs routines to correct for imperfections of the barcode image.
- **Fast**—The tool uses an algorithm that is tailored for speed. The algorithm does NOT correct for barcode image imperfections. The Fast setting has the best results on high-contrast images that contain high-quality barcodes.

Scan Direction sets the direction for Line Scanning:

- **Horizontal**
- **Vertical**
- **Omnidirectional**

The **Omnidirectional** setting should read more barcodes, however it takes longer to do so.

Image Filter adjusts the bar widths with respect to spaces. These settings promote print gain correction.

- **None**—No bar width adjustments are made
- **Under Print Correction**—Enlarges the bar widths with respect to spaces
- **Over Print Correction**—Reduces the bar widths with respect to spaces

Pharmacode

Scan Direction sets the direction for Line Scanning:

- **Left to Right**
- **Top to Bottom**
- **Right to Left**
- **Bottom to Top**
- **Omnidirectional**

Use **Omnidirectional** scanning if barcodes can appear inverted on the part being inspected. If the **Data Compare** test is enabled, the tool attempts to compare that string to read data in both scan directions. The inspection is marked as Pass if at least one string matches. The data that successfully matched the string displays on the screen and exports through communication channels as requested.

If **Omnidirectional** scan is selected, but the **Data Compare** test is disabled, the data read from left-to-right scan is reported.



Note: Pharmacode is not available in **Auto Learn**.

UPC-E

Select so that the tool reads the UPC-E barcode type.

UPC-E Add-On

Select so that the tool reads the UPC-E Add-On barcode type.

Check Digit Verify

When **Check Digit Verify** is enabled, the tool verifies the integrity of the barcode being read.



Note: Most linear barcode types always contain check digit verification. This setting only applies to Code 39 and Interleaved 2 of 5 because the check digit verification is optional in these types.

2D Barcodes

The first time the barcode tool is added, Data Matrix, QR Code, and many 1D barcode types are selected. Select the desired barcode types to be read. As a best practice, select only the applicable barcode type(s) for your particular application to optimize performance.

Figure 269. 2D Barcodes

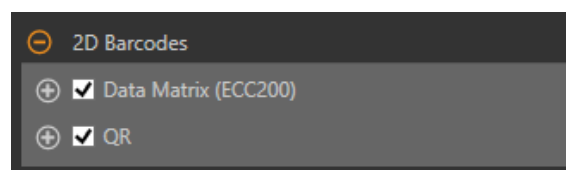

Data Matrix (ECC200)

Decoder Mode

Determines which decode algorithm to use and how imperfections in barcode images are handled.

- **Accurate**—The tool methodically runs multiple image improvement strategies in an attempt to read poorer quality barcodes. The **Accurate** setting is the slowest setting.
- **Robust**—The tool uses an algorithm that performs routines to correct for imperfections of the barcode image.
- **Equalized**—The tool tries to improve the contrast within the symbol to improve readability.
- **Fast**—The tool uses an algorithm that is tailored for speed. The algorithm does not correct for barcode image imperfections. The **Fast** setting has the best results on high-contrast images that contain high-quality barcodes.

Symbol Color

Sets the appropriate symbol color for the application:

- **Black on White**—Select if the barcode symbol color is darker than the background
- **White on Black**—Select if the barcode symbol color is lighter than the background
- **Any**—Select to read both color schemes, however, this setting may result in longer reading time and reduced accuracy

Dot Peen

When **Dot Peen** is enabled, the decoder runs in a method that is optimized for Dot Peen Data Matrix barcodes.



Note: Data Matrix: Dot Peen Mode is not available in **Auto Learn**.

Mirror Image

When **Mirror Image** is enabled (selected), both normal and mirrored images are read. When it is disabled, only normal images are read.

Small Quiet Zone

When **Small Quiet Zone** is enabled, the decoder runs in a method that is optimized for barcodes with less than the ideal amount of open space around the barcode borders. For 2D codes the ideal amount of space is at least one cell width.

Filters

Improve read rates in conditions in which the barcodes are blurred or have nonuniform module sizes.

- **None**—Forces the tool to first try to read barcodes without applying any filters.
- **Non Uniform**—Improves the read rate of barcodes with non-uniformly sized data modules. The time required to read the barcode data may increase with the number of selected filters. The tool runs the most successful filter (since boot-up) first before trying other filters.
- **Out of Focus/Blur**—Improves the read rate of out-of-focus barcodes. Select one or more filters.
 - **Sharpen Level 1**
 - **Sharpen Level 2**
 - **Sharpen Level 3**
 - **Sharpen Level 4**

QR

QR Type

Determines whether the device should read a QR Code, Micro QR code, or both.

- **Both**
- **Standard**
- **Micro**

Symbol Color

Sets the appropriate symbol color for the application:

- **Black on White**—Select if the barcode symbol color is darker than the background
- **White on Black**—Select if the barcode symbol color is lighter than the background
- **Any**—Select to read both color schemes, however, this setting may result in longer reading time and reduced accuracy

Small Quiet Zone

When **Small Quiet Zone** is enabled, the decoder runs in a method that is optimized for barcodes with less than the ideal amount of open space around the barcode borders. For 2D codes the ideal amount of space is at least one cell width.

Mirror Image

When **Mirror Image** is enabled (selected), both normal and mirrored images are read. When it is disabled, only normal images are read.

Postal Barcodes

The first time the barcode tool is added, Data Matrix, QR Code, and many 1D barcode types are selected. Select the desired barcode types to be read. As a best practice, select only the applicable barcode type(s) for your particular application to optimize performance.

Figure 270. Postal Barcodes

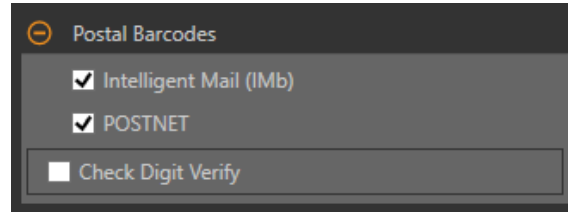

Intelligent Mail (IMb)

Select so that the tool reads the Intelligent Mail (IMb) barcode type.

POSTNET

Select so that the tool reads the POSTNET barcode type.

Check Digit Verify

When **Check Digit Verify** is enabled, the tool verifies the integrity of the barcode being read.

Quality Grading

Use **Quality Grading** to evaluate the quality of a barcode within a specific application based only on the Scan Grade parameters defined in certain International Standards.

Quality Grading does not take into consideration the external environmental lighting parameters such as aperture, wavelength, and illumination angle. All of these can affect the scan grade. These grades are meant to test whether the physical barcode symbol was printed correctly.

Figure 271. Quality Grading

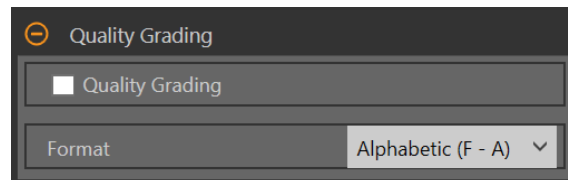

1D and 2D barcodes are graded according to different ISO standards. For 1D barcodes, see ISO 15416. For 2D barcodes, see ISO 15415.

Overall Symbol Grade

Enable to generate one overall grade value for each barcode read.

Format

Select whether the grade is reported in **Alphabetic (F–A)** format or **Numeric (0.0–4.0)** format. In Alphabetic format grades range from A to F, with A being the best. In Numeric format grades range from 0.0 to 4.0, with 4.0 being the best.

Timeout

Set the amount of time the tool executes before it stops.

Figure 272. Timeout

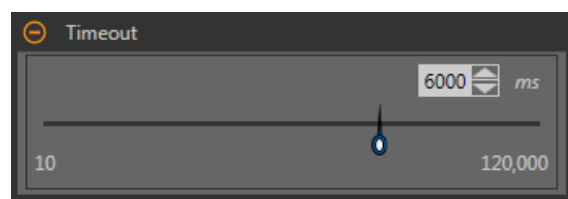
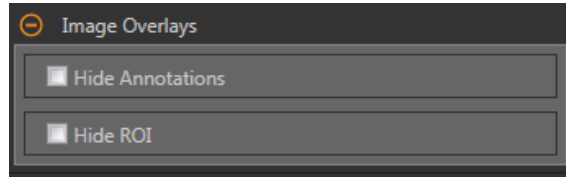



Image Overlays

Choose whether to display or hide the ROI.

Figure 273. Image Overlays—Default



These options override the ROI view buttons  on the Image Pane Parameters when no tool is selected. When a specific tool is selected, the ROI information is shown.

Hide Annotations

Hides the annotations on the live image for the tool, even when the tool is selected.

Hide ROI

Hides the ROI when the tool is **not** selected.

Tool Histogram

The Tool Histogram graphically displays pixel intensity information within the current ROI.

Figure 274. Example Histogram

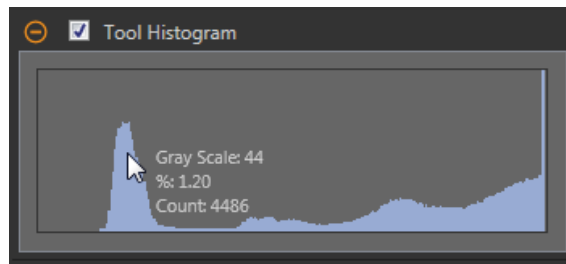

Select the **Tool Histogram** checkbox to enable the histogram. The default is enabled. Expand the **Tool Histogram** parameter to view the histogram.

The histogram is a display of the grayscale values on the x axis and the number of pixels on the y axis. The histogram displays the amount of pixels for each grayscale value. The graph displays information for all grayscale values (0 to 255). Move the pointer anywhere over the histogram to view specific information. The information updates as the position of the pointer changes.

Inspection Pass/Fail

Select the **Contribute to Inspection Pass/Fail** check box (default) if the tool will influence the Pass/Fail status of the inspection.

Figure 275. Inspection Pass/Fail

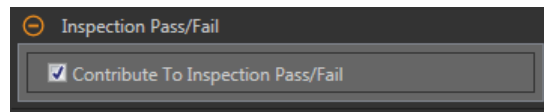

The Pass/Fail contribution influences the following:

- Discrete output Pass
- Discrete output Fail
- Pass/Fail results counter
- Pass (Green) and Fail (red) LEDs on the Sensor

Select this checkbox if the overall Pass/Fail status of the inspection is dependent on the current tool.

9.1.3 Barcode Tool: Test Parameters

Use the **Test** parameters to configure the pass/fail conditions for the tool.

Select the parameter checkbox to enable it. Where applicable, the vertical green bar shows the current parameter information and the light gray backgrounds show the range over which a value has varied over time.

Where applicable, use the sliders or enter the minimum and maximum for the selected test parameters.

The current data found and the range of historical data found are shown for applicable **Test** parameters. The historical data begins from the last reset.

Figure 276. Test Parameters

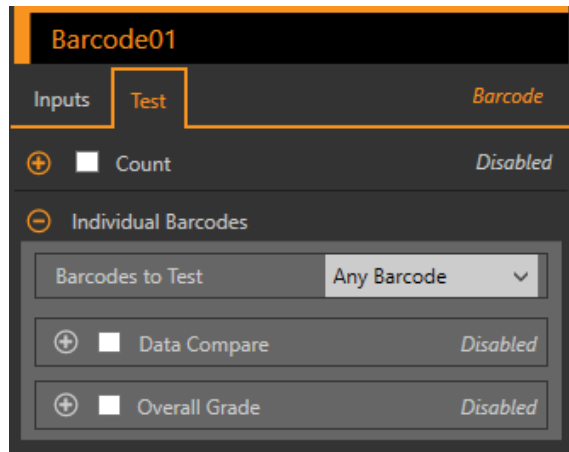

Count

The number of read barcodes.

Individual Barcodes

Barcodes to Test—Select which barcode result will be subject to the test condition.

- **First Barcode**—The first barcode in the results list must pass
- **Any Barcode**—Any one barcode in the results list must pass
- **All Barcodes**—All barcodes in the results list must pass
- **Specific Barcode**—Select a specific Barcode Index number, that barcode number in the results list that must pass

Data Compare—Check to see if read barcodes match the data string entered or taught. This data can be changed from a remote teach input, or over Industrial Ethernet.

Overall Grade—Set the required overall grade value for the read barcodes. This test is available when **Quality Grading** is enabled on the **Inputs** tab.



Note: The following occurs when **Data Compare** and **Overall Symbol Grade** are used simultaneously in the same Barcode tool and the criteria is set to **Any Barcode**: As soon as a barcode is found that matches the Data Compare string, that single barcode is evaluated to pass the Overall Symbol Grade test. All other barcodes are ignored by the Overall Symbol Grade test. If no barcodes pass the Data Compare test, then the Overall Symbol Grade test will fail.

Using Remote TEACH with the Barcode Tool Data Compare Test

If multiple Data Compare tests are used in the same inspection, remote TEACH teaches all Data Compare tests at the same time using the same trigger.

The time to teach is included in the inspection time on **Tools & Results** and **All Results**.

1. Set up the inspection and Barcode tool(s) as desired.
2. In Vision Manager, make sure that one of the five user-defined I/O is set to **Remote Teach**.
3. Toggle the Remote Teach input. The next valid trigger input causes the Remote Teach to occur. This is when the new Data Compare string is learned, by taking the first barcode in the results list.

Setting the Data Compare String with Industrial Protocol Input Strings

The Industrial Protocol Input String data can be inserted as the Data Compare string to compare future barcodes against.

The maximum number of characters is 52. See the section on your protocol for information on how to set the Barcode Data Compare Input String.

To assign the Data Compare string:

1. Make sure that the **Barcode Data Compare Input String** bit on the Input Bits Register is set to 0.
2. If there is more than one Barcode tool in the inspection, set the **Industrial Protocol Tool Index** to be the tool position of the Barcode tool being edited.

Find the index value by counting the Camera tool as tool number one, and counting up one for each tool in the inspection until you reach the Barcode tool.

3. Write the desired string length into the **Industrial Protocol Input String Length** area.
4. Write the desired string content into the **Industrial Protocol Input String** area.
5. Set the **Barcode Data Compare Input String** bit to 1 to apply the custom string.
After the input string is saved in the system, the **Barcode Data Compare Input String Ack** bit will be set to 1.



Note: The specific industrial protocol must be enabled on the **Industrial Protocols** tab.

For register information and input bits, see the following sections:

- [EtherNet/IP](#) on p. 178
- [Modbus/TCP](#) on p. 198
- [PLC5, SLC500, and MicroLogix \(PCCC\)](#) on p. 207
- [PROFINET](#) on p. 217

9.1.4 Barcode Tool: Results

Tools & Results and **All Results** list information from the current and previous inspections.

A red box around a tool indicates that the tool failed. **Status** provides information about the specific failure.

All Results displays the Result, Time, Pass Count, and Fail Count information at a glance. Expand the inspection tool to see specific results for that tool.

Barcode Count

The total number of barcodes read within the ROI.

Expand **Barcode Count** to see a list of all barcodes read by this tool, sorted in order of position, from top to bottom. This results table lists each barcode symbology, length, data, and Code Quality Grade, when grading is enabled.

Execution Time

The execution time, in milliseconds, for the currently selected tool in the current inspection.

Expand **Execution Time** to see the historical minimum and maximum execution times up to this point for the selected tool.

Use the reset button in the Inspection Summary to reset these historical values.

Status

Status and error messages display as appropriate.

9.1.5 Using the Barcode Tool

Follow these steps to configure a Barcode tool sample application. The Barcode tool reads most types of barcodes right away, but reads faster with optimization.

The Barcode tool uses one ROI which defines the area that the tool searches for barcodes. This ROI cannot be rotated and it is always a rectangle. The default ROI covers the entire image for maximum readability.



Note: This procedure is an example only.

1. Add a **Barcode** tool to the inspection.
A barcode visible in the ROI should be read right away unless an advanced feature such as Mirror Image or Image Filter is needed. When a barcode is read, the barcode is shown with a box around it in the image.

Figure 277. Read Barcode

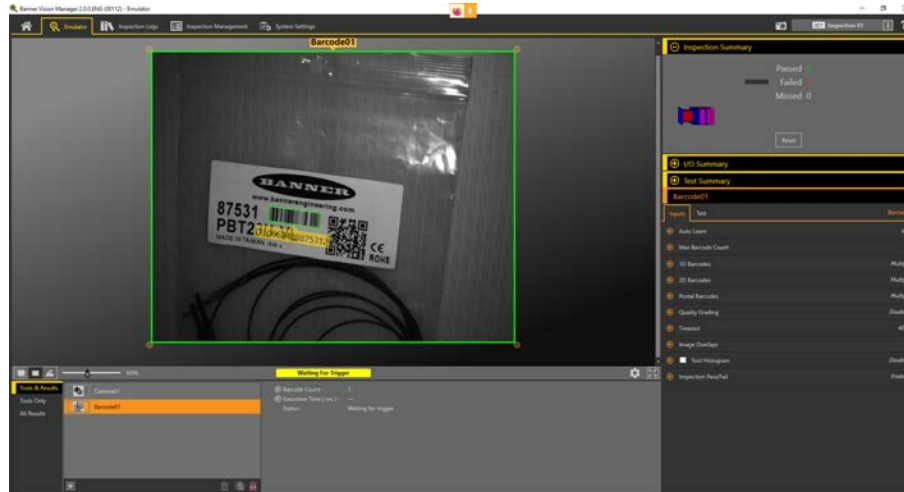

2. If at least one desired barcode is read right away, go to step 3. If no barcode is read right away, consider the following ways to improve image readability to increase chances of success in the next step:
 - Adjust the focus and brightness until you have a clear, high-contrast image
 - If the smallest modules of the barcode appear to be less than 3 pixels wide, try moving closer to increase resolution
3. On the **Parameters** pane, expand **Auto Learn** and click **Start**.

Figure 278. Auto Learn

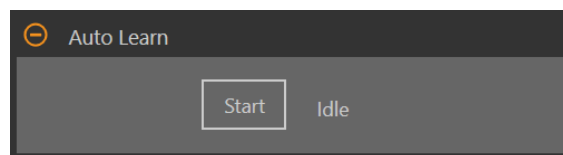

A search runs to find up to 10 barcodes in the image. Then the Max Barcode Count is set to the number of found barcodes. Any barcodes found are listed in the **Auto Learn** results window. Any barcode symbologies that are not found are disabled. All other Input parameter selections are reset, except for the size and placement of the ROI.

Figure 279. Barcodes Found

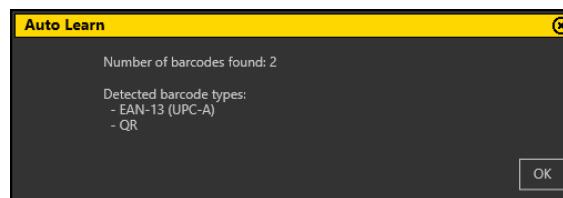
**Note:**

Auto Learn does not read Pharmacode barcodes. To read a Pharmacode, skip step 3 and manually enable Pharmacode in the 1D code settings. Disable all other 1D, 2D and Postal symbologies for best performance.

Auto Learn does not enable Data Matrix: Dot Peen mode. If you have a Dot Peen Data Matrix, manually enable the Dot Peen setting. Disable all other 1D, 2D and Postal symbologies for best performance.

4. Click **OK**.
5. On the **Test** tab, select **Count** to enable the **Count** test parameter.
6. Expand **Count** and set the minimum and maximum to the number of barcodes desired in your application. In this example, the minimum and maximum are set to two. The test will only pass when all of the desired barcodes are read.
7. Test a complete range of good and bad samples to make sure that the sensor accepts good parts and rejects bad parts.

Figure 280. Good Part—Two Barcodes Read

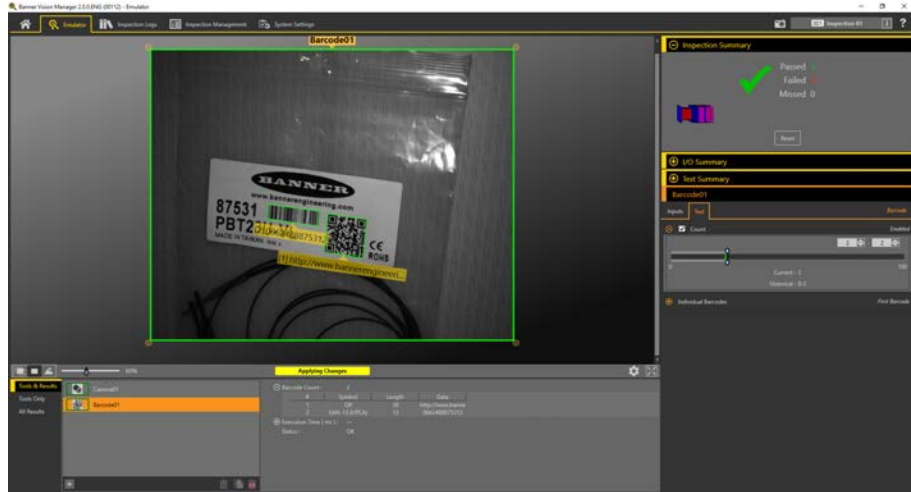
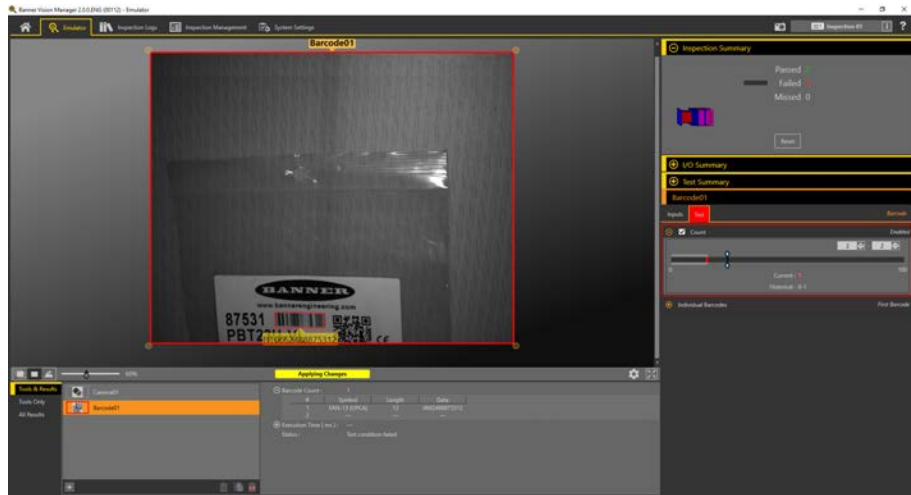

Figure 281. Bad Part—Only One Barcode is Readable



10 Using the Inspection Tools: Analysis Tools

Analysis tools include Math, Measure, and Logic.

Click a tool on **Tools & Results** or **Tools Only** to access the **Parameters** pane for that tool.

10.1 Math Tool

Use the Math tool to perform basic arithmetic and inequality expressions, and to calculate statistical information for inspections.

The Math tool takes one or more pieces of information from the tool data or from user-supplied constants and makes mathematical expressions out of them. The results of the Math tool's analysis are displayed in **Tools & Results** and **All Results**.

The inputs to the Math tool are called operands. The operation is the mathematical expression used on the operands.

In general, a user-defined constant can be selected as one of the operands for the Math tool. This allows for a number of things, including scaling the output of a vision tool in real units (by dividing that output by a known conversion factor).

Dynamic scaling of outputs is also possible by dividing one operand by another and then multiplying by a constant conversion factor. In this case, two Math tools would be used: one set for division, the other for multiplication. The output of the first Math tool would be an operand for the second Math tool.

Example application: Add advanced logic to an inspection using arithmetic or inequality expressions.

10.1.1 Math Tool: Input Parameters

Use the **Input** parameters to configure how the tool analyzes an image.

Figure 282. Math Tool—Input Parameters



Operator

Select the type of mathematical expression used for the inspection operator.

Figure 283. Operator

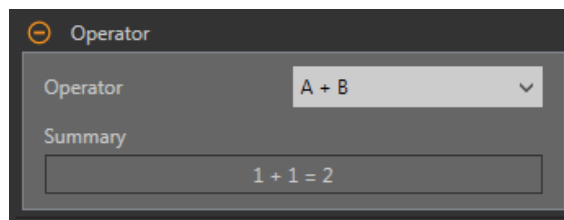

Table 2: Single Operand Operations

Single operand operations require one input.

Operator	Summary	Description
ABS {A}	ABS(1) = 1	The absolute value of an operand is its unsigned magnitude. For example, ABS(-1.5) and ABS(1.5) both return 1.5
SQRT {A}	SQRT(1) = 1	The square root of the operand

Table 3: Dual Operand Operations

Dual operand operations require two inputs (operand A and operand B). For each operand, specify the tool (or a constant) and the specific attribute of interest for that tool.

Operator	Summary	Description
A + B	1 + 1 = 2	Add
A - B	1 - 1 = 0	Subtract
A * B	1 × 1 = 1	Multiply
A / B	1 ÷ 1 = 1	Divide
MOD {A, B}	1 % 1 = 0	Modulus; the modulus, or remainder, operator divides operand A by operand B and returns the remainder
Div {A, B}	1 ÷ 1 = 1	Integer division; returns the integer part of division, and the remainder is discarded
ABS (A - B)	1 - 1 = 0	Returns the absolute value of operand A – B
A > B	1 > 1 = false	Greater than; returns True, else False
A ≥ B	1 ≥ 1 = true	Greater than or equal to; returns True, else False
A = B	1 = 1 = true	Equal to; returns True, else False
A < B	1 < 1 = false	Less than; returns True, else False
A ≤ B	1 ≤ 1 = true	Less than or equal to; returns True, else False

If the output of a relational operation is used as an input for another Math Tool, True is interpreted as 1 and False is interpreted as 0.

Table 4: Array Operand Operations

Array Operations allow the user to make a long list of input data. All of these pieces of information are inputs to the selected operator. For example, select MIN{A} as the operator, and select an input tool.

Operator	Description
MIN{A}	Minimum—Returns the operand with the lowest value
MAX{A}	Maximum—Returns the operand with the highest value
MEAN{A}	Returns the mean value of the operands
MEDIAN{A}	The statistical median is the middle number of a group of numbers that have been arranged in order by size. If there is an even number of terms, the median is the mean of the two middle numbers.
COUNT{A}	Returns the count of the operands
SUM{A}	Returns the arithmetic sum of the operands
VAR{A}	Variance—A measure of how spread out the operands values are
STDDEV{A}	Standard Deviation—A measure of how spread out the operands values are

Operand A

Choose the first variable from the vision tools in the inspection, or select a user-defined constant value.

Figure 284. Operand A

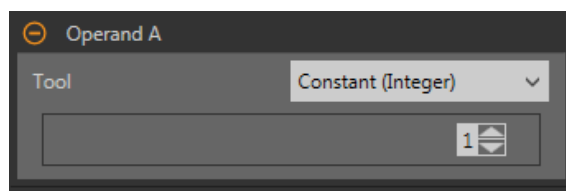

Operand B

Choose the second variable from the vision tools in the inspection, or select a user-defined constant value.

Figure 285. Operand B

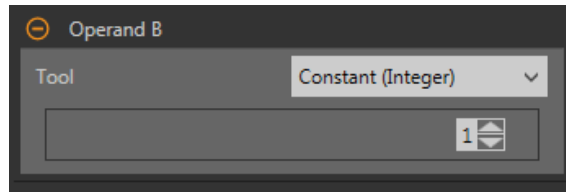

Inspection Pass/Fail

Select the **Contribute to Inspection Pass/Fail** check box (default) if the tool will influence the Pass/Fail status of the inspection.

Figure 286. Inspection Pass/Fail

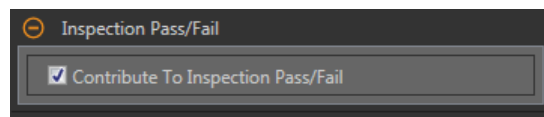

The Pass/Fail contribution influences the following:

- Discrete output Pass
- Discrete output Fail
- Pass/Fail results counter
- Pass (Green) and Fail (red) LEDs on the Sensor

Select this checkbox if the overall Pass/Fail status of the inspection is dependent on the current tool.

10.1.2 Math Tool: Test Parameters

Use the **Test** parameters to configure the pass/fail conditions for the tool. Select the parameter checkbox to enable it.

Figure 287. Math Tool—Test Parameters

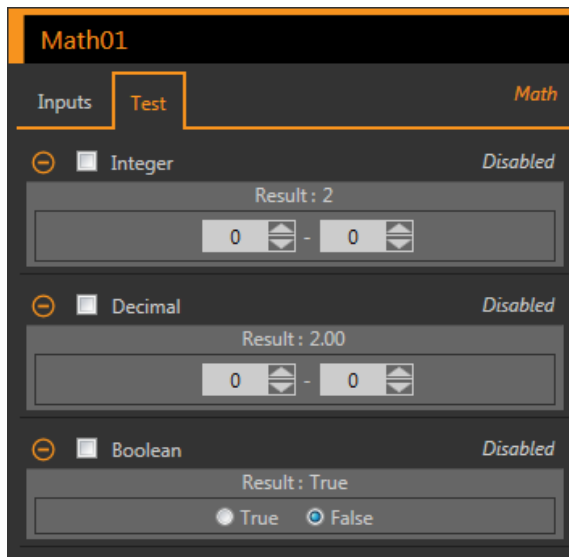

Integer

The integer value range of the Math tool operation.

Decimal

The decimal value range of the Math tool operation.

Boolean

The Boolean result for the Math tool operation.

10.1.3 Math Tool: Results

Tools & Results and **All Results** list information from the current and previous inspections.

A red box around a tool indicates that the tool failed. **Status** provides information about the specific failure.

All Results displays the Result, Time, Pass Count, and Fail Count information at a glance. Expand the inspection tool to see specific results for that tool.

Integer Result

The integer value result of the Math tool operation.

Decimal Result

The decimal result of the Math tool operation.

Boolean

The Boolean result for the Math tool operation.

Execution Time

The execution time, in milliseconds, for the currently selected tool in the current inspection.

Expand **Execution Time** to see the historical minimum and maximum execution times up to this point for the selected tool.

Use the reset button in the Inspection Summary to reset these historical values.

Status

Status and error messages display as appropriate.

10.1.4 Using the Math Tool

Follow these steps for an example Math inspection.

This example uses two Edge tools and a Math tool to determine whether the number of edges found by Edge01 is greater than the number of edges found by Edge02. See [Using the Edge and Measure Tools](#) on p. 105 for more information on using the Edge tool.



Note: This procedure is an example only.

1. Add an Edge tool to the inspection.
2. Move the Edge01 ROI over the shapes in the image.

Figure 288. Edge01 ROI

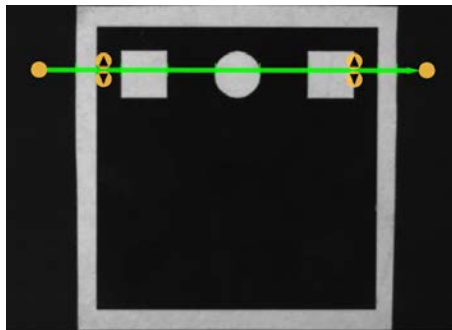

3. Add a second Edge tool to the inspection.
4. Move the Edge02 ROI over the black area of the image.

Figure 289. Edge02 ROI

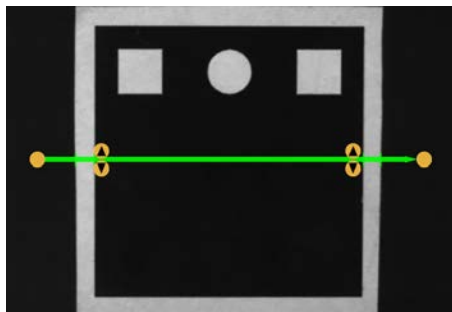

5. Add a Math tool to the inspection.
6. Expand **Operator** and choose a mathematical function to perform. For this example, select **A > B**.
7. Expand **Operand A** and select **Edge01**. This is the first variable or constant for the mathematical expression.

8. Expand **Operand B** and select **Edge02**. This is the second variable or constant for the mathematical expression.
9. Set the Test parameters to set the pass/fail criteria.
 - a) On the **Test** tab, select the **Boolean** checkbox.
This option sets whether the mathematical expression is true or false so that the part passes.
 - b) Select **True**.
Edge01 must find more edges than Edge02 for a part to pass.
10. Test a complete range of good and bad samples to make sure that the sensor accepts good parts and rejects bad parts.

Figure 290. Edge02 ROI

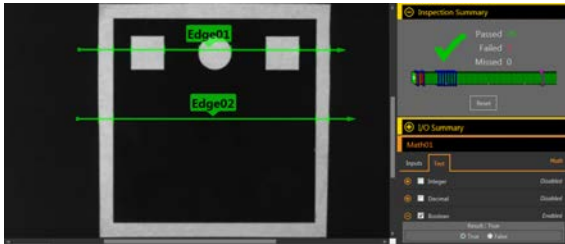
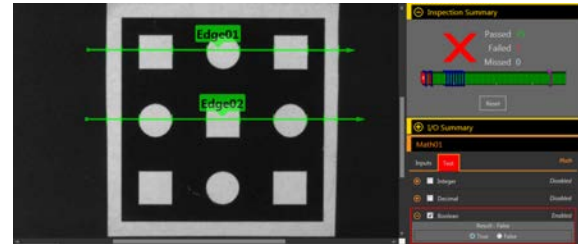

Figure 291. Edge02 ROI



10.2 Measure Tool

Use the Measure tool to determine distances, calculate angles, and create points and lines for use as inputs to other Measure tools.

The Measure tool operations are:

- Measure from a point to a point
- Determine the intersection between two lines
- Measure from a line to a point

The points used in these operations are generated by a variety of vision tools and the lines are created by other Measure tools.

Example applications:

- Determine the distance between blobs
- Measure the width of a label
- Determine if two edges are parallel to each other

10.2.1 Measure Tool: Operations

Measure from a Point to a Point

In this operation, the distance between two points is calculated. In addition, the x and y components of that distance calculation are returned.

Along with distance, the following results are generated in this operation:

- A line from point 1 to point 2
- The angle of that line (relative to the x-axis)
- The midpoint location halfway between point 1 and point 2

How the Tool Measures Two Points

The inputs to the Measure tool for measuring two points are any two points that vision tools generate.

The results include the total distance between the points and the x and y component distances. In addition to finding these distance values, the Measure tool also calculates the line between the two endpoints. The angle between this line and the camera's horizontal plane, as well as the coordinates for the line's midpoint, are also provided.

For example, a Measure01 measurement between the two points Edge01 and Edge02 appears as a dashed line. The actual measured distance between the points is a solid green line labeled Measure01 and an arrowhead indicates the direction of the measurement operation (from Edge01 to Edge02, in this case). A blue circle is the midpoint. Two shorter dashed lines represent the x and y components. The angle between Measure01 and the horizontal plane is a curved arrow. The results show the angle in degrees.

See [Using the Edge and Measure Tools](#) on p. 105 for a Measure tool example.

Intersect Two Lines

In this operation, the results of the intersection of two lines is generated. These results are:

- The angle of intersection between the two lines, measure from line 1 to line 2
- The intersection point, even if this point is not in the image

How the Tool Measures Two Lines

This mode finds the angle between two lines. Both inputs are the line outputs from existing Measure tools. The order in which these tools are input matters.

The intersection point can be off of the screen. This angle provides the ability to measure two lines for parallelism.

For example, if you have two inputs that are both existing Measure tools, Measure01 and Measure02, the output, called Measure03, is the angle between the lines of each of the inputs. Measure03 is a curved arrow from the first input, Measure01, towards the arrowhead of the second input, Measure02. The results show this angle in degrees. The intersection point of the two best fit lines is also provided in the results and is shown by the blue circle in the image pane.

See [Using the Edge and Measure Tools](#) on p. 105 for a Measure tool example.

Measure from a Line to a Point

In this operation, the software calculates the distance between a line and a point. This is the shortest distance from the line to the point, and is generated by creating a line perpendicular to the original line that intersects the point. In addition, it returns the distance calculations for the X and Y component.

Additionally, the following results are generated in this operation:

- The perpendicular line, which goes from the line to the point
- The angle of that line (relative to the x-axis)
- The intersection point between the original line and the perpendicular line

How the Tool Measures a Line and a Point

This mode finds the shortest distance between a point and a line.

The two inputs to the Measure tool are:

- Any point a vision tool generates
- Any line another measure tool generates

The shortest distance between a line and a point may lie along another line. This new line may be perpendicular to the original line.

For example, the center point of a blob, Blob01, and the nearest point in the input line Measure01 define a dashed line. The actual measured distance between Blob01 and Measure01 is labeled Measure02. A blue circle shows where Measure01 and Measure02 intersect. The results show the distance between the intersection point and the blob midpoint in pixels. Two shorter dashed lines represent the x and y components. The angle between Measure02 and the horizontal plane is a curved arrow. The results show this angle in degrees.

See [Using the Edge and Measure Tools](#) on p. 105 for a Measure tool example.

10.2.2 Measure Tool: Input Parameters

Use the **Input** parameters to configure how the tool analyzes an image.

Figure 292. Measure Tool—Input Parameters

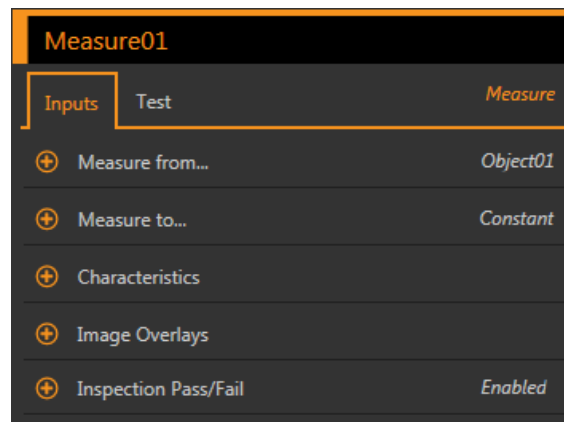

Measure from...

Select either a constant or another tool where the Measure tool will start measuring from.

Figure 293. Measure From...—Specific Tool Selected

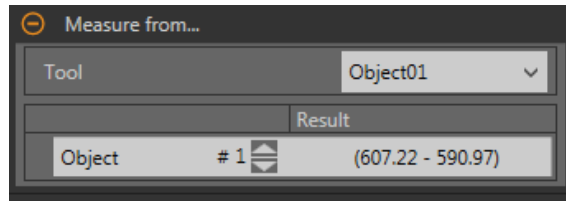

If selecting a constant, enter the x and y coordinates to begin the measurement from. The coordinates are entered in pixels, however if Units is enabled, the value entered in pixels is converted to units for the calculation.

If selecting a specific tool, select the specific characteristic in the tool to measure from.

Measure to...

Select either a constant or another tool where the Measure tool will stop measuring.

Figure 294. Measure To...—Constant Selected

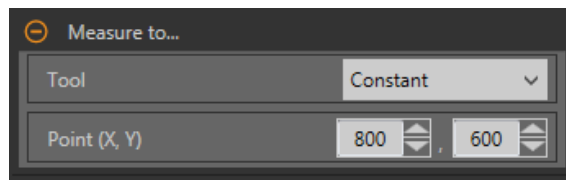

If selecting a constant, enter in the x and y coordinates to end the measurement at. The coordinates are entered in pixels, however if Units is enabled, the value entered in pixels is converted to units for the calculation.

If selecting a specific tool, select the specific characteristic in the tool to measure to.

Characteristics

Set additional parameters for the inspection.

Figure 295. Characteristics

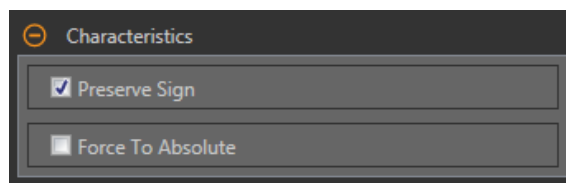

Preserve Sign

When **Preserve Sign** is selected, the x and y distances are computed as distance offsets. These distance offsets are represented by signed numbers. Negative numbers indicate that the distance offset is toward the origin (0,0). Positive numbers indicate that the distance offset is away from the origin.

Force to Absolute

Select **Force to Absolute** to change the tool from calculating the x and y components of the measurement from relative positioning to absolute positioning. When disabled, the tool ROI positions itself independent to any other reference tool preceding it in the inspection.

Image Overlays

Choose whether to display or hide the annotations when this tool is **not** selected.

Figure 296. Image Overlays

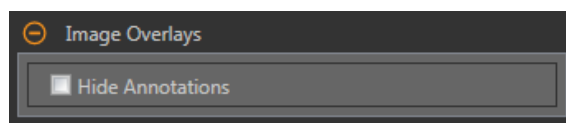

This option overrides the ROI view buttons  on the Image Pane Parameters when no tool is selected. When a specific tool is selected, the ROI information is shown.

Figure 297. Show Measure Tool Annotations

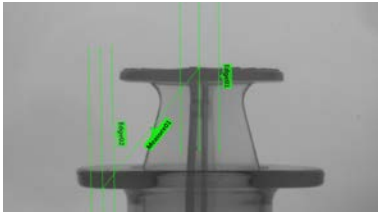
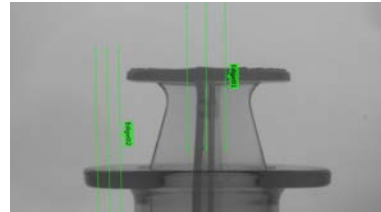

Figure 298. Hide Measure Tool Annotations



Inspection Pass/Fail

Select the **Contribute to Inspection Pass/Fail** check box (default) if the tool will influence the Pass/Fail status of the inspection.

Figure 299. Inspection Pass/Fail

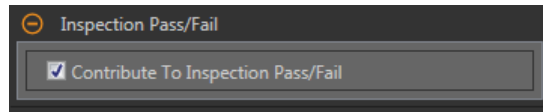

The Pass/Fail contribution influences the following:

- Discrete output Pass
- Discrete output Fail
- Pass/Fail results counter
- Pass (Green) and Fail (red) LEDs on the Sensor

Select this checkbox if the overall Pass/Fail status of the inspection is dependent on the current tool.

10.2.3 Measure Tool: Test Parameters

Use the **Test** parameters to configure the pass/fail conditions for the tool.

Select the parameter checkbox to enable it. Where applicable, the vertical green bar shows the current parameter information and the light gray backgrounds show the range over which a value has varied over time.

Where applicable, use the sliders or enter the minimum and maximum for the selected test parameters.

The current data found and the range of historical data found are shown for applicable **Test** parameters. The historical data begins from the last reset.

Figure 300. Measure Tool—Test Parameters

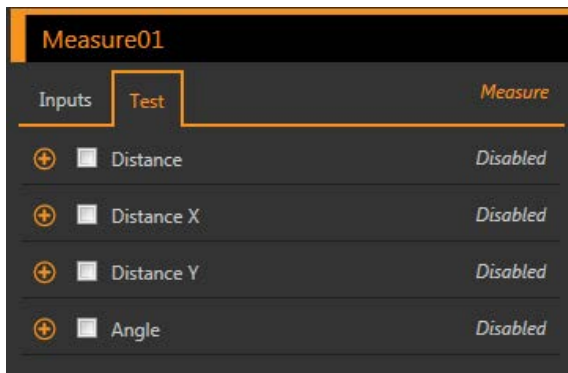

Distance

The straight-line distance between two constants or tools.

Distance X

The x dimension vector component of the straight line distance.

Distance Y

The y dimension vector component of the straight line distance.

Angle

The angle with respect to the x axis, along which the straight line measurement vector lies. If the tool is measuring from one Line tool to another Line tool, the Angle is the measurement of the angle formed by the two lines. If the Force to Absolute parameter is selected, the angle is calculated relative to the reference tool that precedes the Measure tool.

10.2.4 Measure Tool: Results

Tools & Results and **All Results** list information from the current and previous inspections.

A red box around a tool indicates that the tool failed. **Status** provides information about the specific failure.

All Results displays the Result, Time, Pass Count, and Fail Count information at a glance. Expand the inspection tool to see specific results for that tool.

Distance

The straight-line distance between two constants or tools.

Distance X

The x dimension vector component of the straight line distance.

Distance Y

The y dimension vector component of the straight line distance.

Angle

The angle with respect to the x axis, along which the straight line measurement vector lies. If the tool is measuring from one Line tool to another Line tool, the Angle is the measurement of the angle formed by the two lines. If the Force to Absolute parameter is selected, the angle is calculated relative to the reference tool that precedes the Measure tool.

Mid Point

The x and y coordinates of the middle point between the two selected points.
Mid Point is calculated for point to point measurements only.

Projection Point

The x and y coordinates of the intersection point between the input line and a virtual line passing through the input point. The virtual line is orthogonal (perpendicular) to the input line. The intersection point is on the input line because the other line does not exist (virtual).

Projection Point is calculated for line to point measurements only.

Intersection Point

The x and y coordinates of the intersection point of two non-coincident input lines.
Intersection Point is calculated for line to line measurements only.

Execution Time

The execution time, in milliseconds, for the currently selected tool in the current inspection.

Expand **Execution Time** to see the historical minimum and maximum execution times up to this point for the selected tool.

Use the reset button in the Inspection Summary to reset these historical values.

Status

Status and error messages display as appropriate.

10.2.5 Using the Edge and Measure Tools

Follow these steps for an example Edge inspection to check the position of a plunger in a syringe.

This procedure uses two Edge tools and a Measure tool to determine the position of the plunger in the barrel.



Note: This procedure is an example only.

1. Add an Edge tool to the inspection.
2. Adjust the ROI position, length, and width.
 - a) Position the ROI vertically over the top of the plunger.
 - b) Expand **ROI**, then expand **ROI Width**.
 - c) Set the ROI width to 161 px.

Figure 301. ROI Over the Top of the Plunger

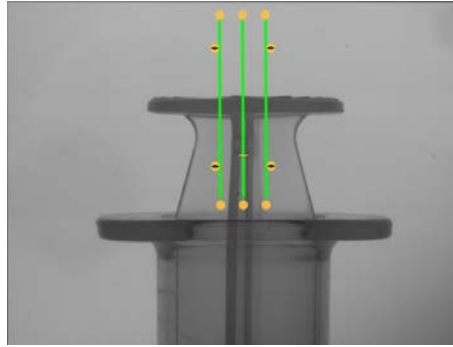

3. Set the threshold.
 - a) Expand the **Threshold** parameters.
 - b) Set the **Threshold Type** to **Edge Strength**.
 - c) Leave **Edge Strength** at the default (20).
 - d) Select **Bright to Dark** from the **Edge Polarity** list.

The tool finds the top of the plunger.
4. Add a second Edge tool.
5. Adjust the ROI position, length, and width.
 - a) Position the ROI vertically over the top of the barrel.
 - b) Expand **ROI**, then expand **ROI Width**.
 - c) Set the ROI width to 97 px.

Figure 302. ROI Over the Top of the Barrel

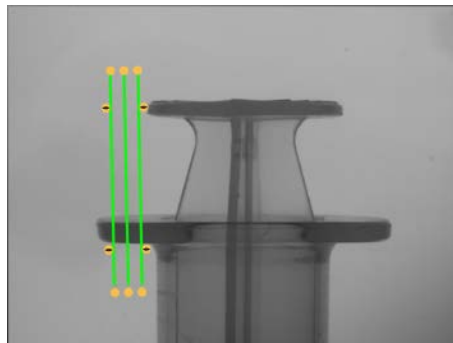

6. Set the threshold.
 - a) Expand the **Threshold** parameters.
 - b) Set the **Threshold Type** to **Edge Strength**.
 - c) Expand **Edge Strength** and set it to 21.
 - d) Select **Dark to Bright** from the **Edge Polarity** list.

The tool finds the lower edge of the barrel.
7. Add a Measure tool.
 - a) Expand **Measure From...** and select **Edge02** from the **Tool** list.
 - b) Expand **Measure To...** and select **Edge01** from the **Tool** list.

Figure 303. Measure Tool

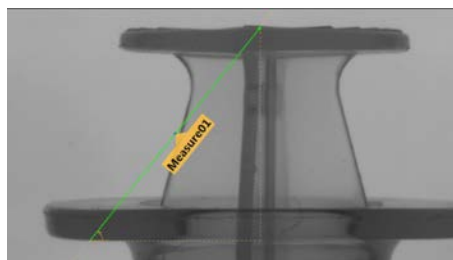

8. Set the **Test** parameters to set the pass/fail criteria.

- a) On the **Test** tab, select the **Distance Y** checkbox to enable the test parameter.
- b) Move the sliders slightly above and below the green line to allow for very slight variations in the distance.



Note: The green bar indicates the current distance and the light gray background indicates the distance over time.

9. Click  to show all ROIs at the same time.

Figure 304. All Tools Shown



10. Test a complete range of good and bad samples to make sure that the sensor accepts good parts and rejects bad parts.

Figure 305. Good Part

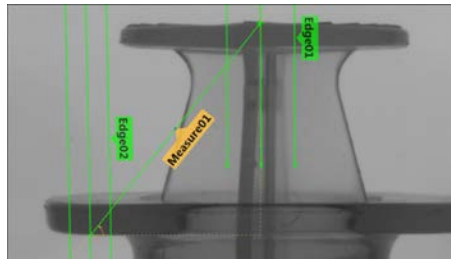
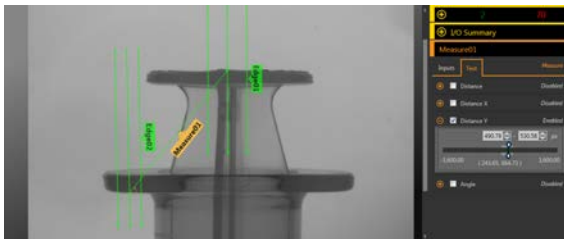
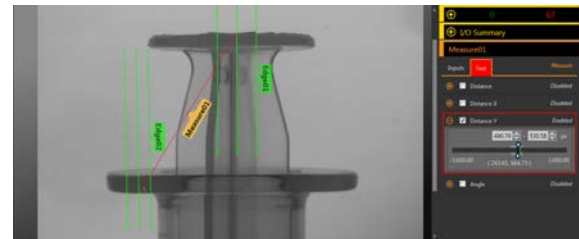

Figure 306. Bad Part—Plunger Too High



10.3 Logic Tool

Use the Logic tool to combine or convert tool results, or to drive discrete outputs from tool results.

The Logic tool uses Boolean logic to combine or convert tool results. The logic output can be used to pass or fail the inspection or to drive a discrete output. The results of the Logic tool's analysis are displayed in **Tools & Results** and **All Results**.

The inputs to the Logic tool are called operands. The camera tool, vision tools, or analysis tools can be operands if they are added to the current inspection. The operation is the logical expression used on the operands. AND, OR, and XOR logic are available.

AND

A true output results if all inputs are true.

OR

A true output results if one or more of the inputs are true.

XOR

A true output results if one, and only one, of the inputs is true.

Example uses:

- Gather results from the camera tool, vision tools, or analysis tools
- Establish parameters for desired inspection results
- Tie multiple results together with logic options
- Include results in the overall Pass/Fail criteria
- Activate a discrete output based on the inspection results
- Part sorting applications

10.3.1 Logic Tool: Input Parameters

Use the **Input** parameters to configure how the tool analyzes an image.

Figure 307. Logic Tool—Input Parameters

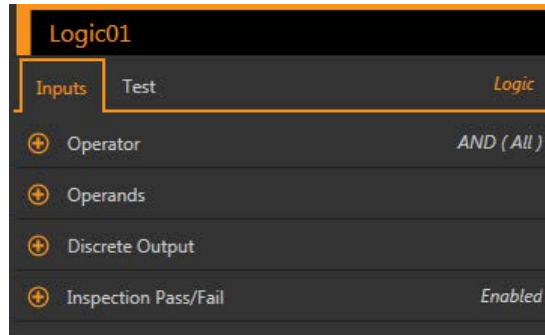

Operator

Select the type of logical expression used for the Logic tool operator.

Figure 308. Operator

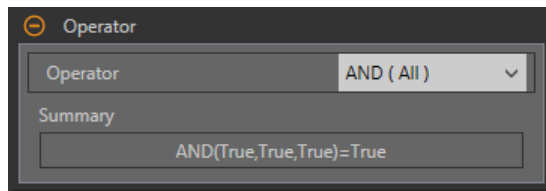

Operator	Summary/Examples	Description
AND (All)	AND(True, True, True)=True AND(True, False, True)=False	A true output results if all inputs are true.
OR (Any)	OR(True, True, True)=True OR(True, False, True)=True	A true output results if one or more of the inputs are true.
XOR (Only one)	XOR(True, True, True)=False XOR(True, False, True)=False	A true output results if one, and only one, of the inputs is true.

Operands

Choose the variables from the tools found in the inspection. The current tool result displays in the Result column.

Figure 309. Operands

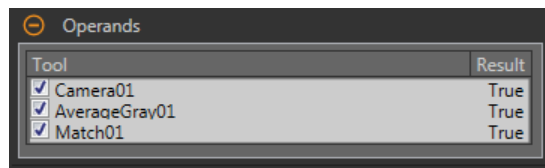

The desired operands must be listed before the Logic tool in the **Tools and Results** pane so that they can be used by the Logic tool. Each operand must have its test criteria enabled for the Logic tool to use it.

Discrete Output

Select whether the Logic tool activates one of the five programmable I/O and what the active condition is.

Figure 310. Discrete Output—Output Active

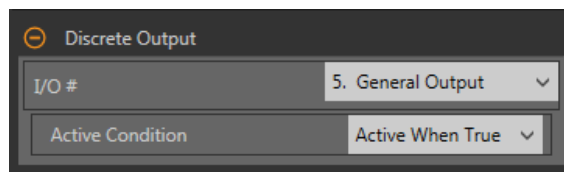

I/O #

Select the desired **General Output** I/O number.

To select and use I/O 1-5 in the Logic tool Discrete Output parameter, at least one I/O must be configured as General Output in the system settings. Click **System Settings > Discrete I/O** and select **General Output** from the **Function** list for the desired I/O.

Active Condition

Select when the output is active—either when the result is True or when the result is False.

Available when an **I/O #** is selected.

Inspection Pass/Fail

Select the **Contribute to Inspection Pass/Fail** check box (default) if the tool will influence the Pass/Fail status of the inspection.

Figure 311. Inspection Pass/Fail

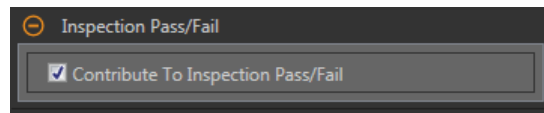

The Pass/Fail contribution influences the following:

- Discrete output Pass
- Discrete output Fail
- Pass/Fail results counter
- Pass (Green) and Fail (red) LEDs on the Sensor

Select this checkbox if the overall Pass/Fail status of the inspection is dependent on the current tool.

10.3.2 Logic Tool: Test Parameters

Use the **Test** parameters to configure the pass/fail conditions for the tool. Select the parameter checkbox to enable it.

Figure 312. Logic Tool—Test Parameters

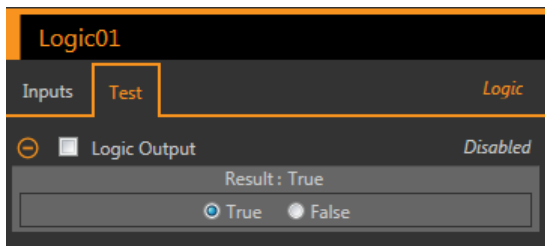
**Logic Output**

The Boolean result for the Logic tool operation.

10.3.3 Logic Tool: Results

Tools & Results and **All Results** list information from the current and previous inspections.

A red box around a tool indicates that the tool failed. **Status** provides information about the specific failure.

All Results displays the Result, Time, Pass Count, and Fail Count information at a glance. Expand the inspection tool to see specific results for that tool.

Logic Output

The Boolean result for the Logic tool operation.

Execution Time

The execution time, in milliseconds, for the currently selected tool in the current inspection.

Expand **Execution Time** to see the historical minimum and maximum execution times up to this point for the selected tool.

Use the reset button in the Inspection Summary to reset these historical values.

Status

Status and error messages display as appropriate.

10.3.4 Using the Logic Tool

Follow these steps for an example inspection that uses the Logic tool.

This example uses two Match tools and two Logic tools. The Match tools are taught independently. Each Match tool determines the presence or absence of a different logo on different size boxes. The first Logic tool passes the inspection if either Match tool finds its respective logo. The second Logic tool turns on an output if a specific logo is found. This output could be used to turn on a light or to send the box to a different line. See [Using the Match Tool](#) on p. 128 for more information on using the Match tool.



Note: This procedure is an example only.

1. Add a Match tool to the inspection.
 - a) Configure Match01 to recognize the logo on the small box.
 - b) Expand **Inspection Pass/Fail** and remove the checkmark to disable the parameter.
 - c) On the **Test** tab, select the **Count** checkbox to enable the **Count** test parameter.
 - d) Expand **Count** and set it to a minimum of 1 and a maximum of 1.

Figure 313. Match01

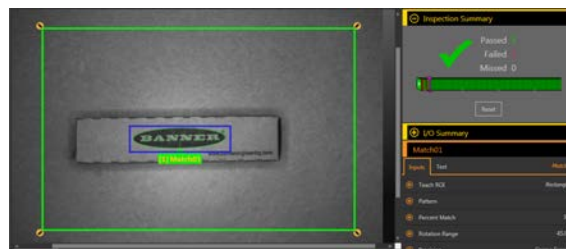

2. Add a second Match tool.
 - a) Configure Match02 to recognize the logo on the large box.
 - b) Expand **Inspection Pass/Fail** and remove the checkmark to disable the parameter.
 - c) On the **Test** tab, select the **Count** checkbox to enable the **Count** test parameter.
 - d) Expand **Count** and set it to a minimum of 1 and a maximum of 1.

Figure 314. Match02

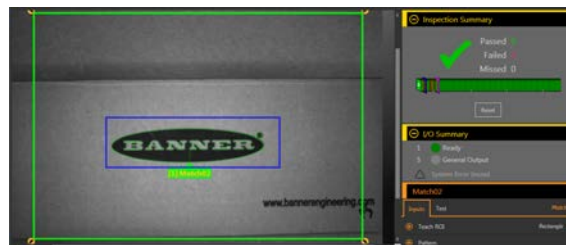

3. Add a Logic tool.
4. Expand **Operator** and choose the logical expression to perform. For this example, choose **OR (Any)**.
5. Expand **Operands** and select the tools to include in the analysis.
 - a) Remove the checkmark from Camera01 to exclude it.
 - b) Select the Match01 and Match02 checkboxes to include them.
6. Leave **Inspection Pass/Fail** selected (default).
7. Set the Test parameters to set the pass/fail criteria.
 - a) On the **Test** tab, select the **Logic Output** checkbox.
This option sets whether the Boolean logic is true or false so that the part passes.
 - b) Select **True**.
If any box has a logo, the Logic tool and inspection pass.
8. Add a second Logic tool to the inspection.
9. Expand **Operator** and choose the logical expression to perform. For this example, choose **AND (Any)**.
10. Expand **Operands** and select the tools to include in the analysis.
 - a) Remove the checkmark from Camera01 to exclude it.
 - b) Select the Match01 checkbox to include it.
11. Set the Discrete I/O.
 - a) Click **System Settings > Discrete I/O**.

- b) Select **General Output** as the Function for one I/O. This example uses I/O 5.
12. Set the Discrete Output parameter for the Logic tool.
 - a) Expand **Discrete Output**.
 - b) Select the desired I/O from the I/O # list. In this example, select **5. General Output**.
 - c) Leave the **Active Condition** as **Active when True** (default).
13. Expand **Inspection Pass/Fail** and remove the checkmark to disable the parameter.
14. Set the Test parameters to set the pass/fail criteria.
 - a) On the **Test** tab, select the **Logic Output** checkbox. This option sets whether the Boolean logic is true or false so that the part passes.
 - b) Select **True**. The small box must have the logo to create the general output.
15. Expand the I/O Summary so that you can see the results.

Figure 315. I/O Summary—Small Box Passes with Output

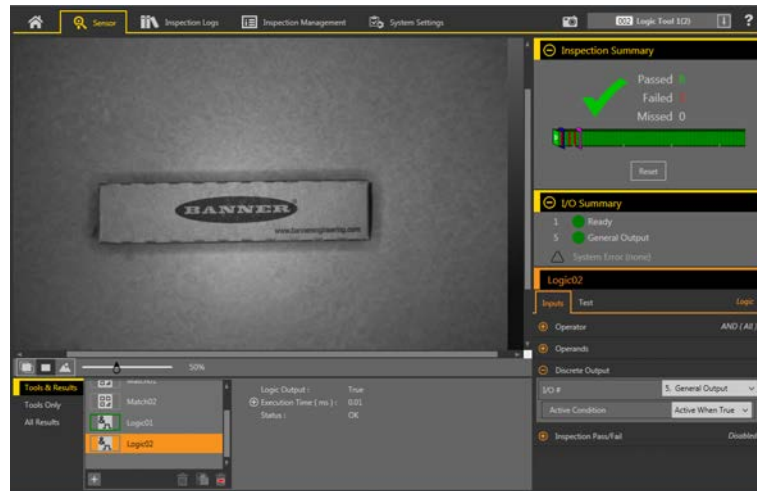

Figure 316. I/O Summary—Large Box Passes with no Output



16. Test a complete range of good and bad samples to make sure that the sensor accepts good parts and rejects bad parts.

11 Emulators





Use **Emulators** on the  **Home** screen to connect to the emulator.

Figure 317. Emulators

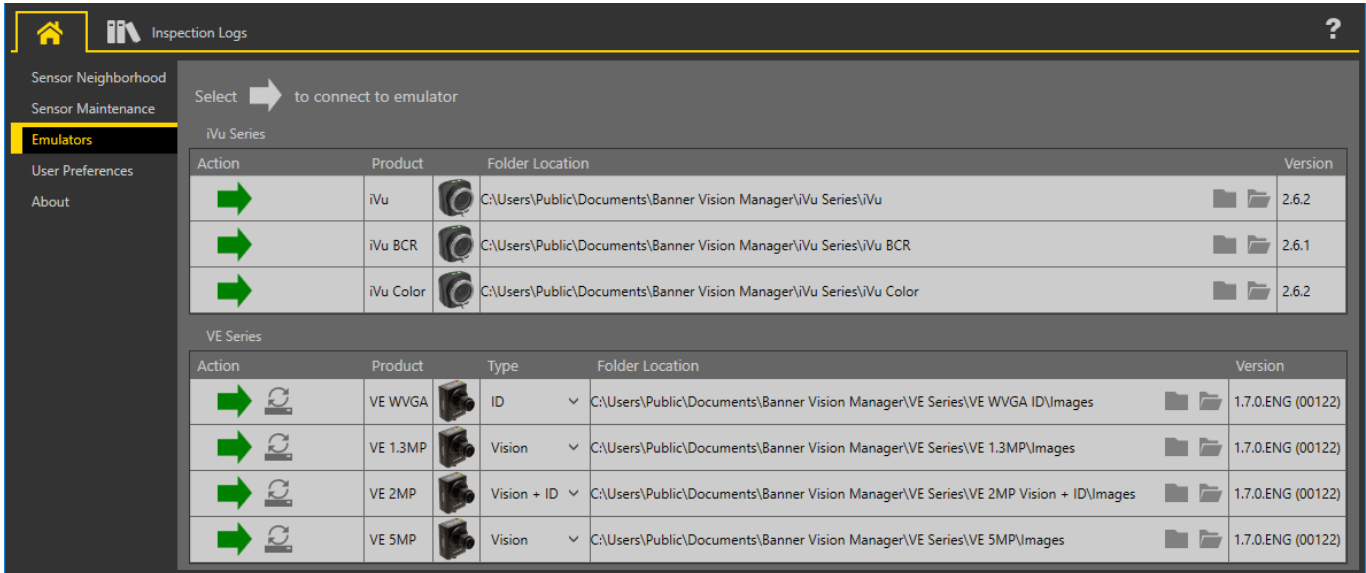

Click  to connect to the desired emulator. This tab also displays the Image location on the computer, as well as the emulator version information.

To access the emulator for different types of the VE models, select the desired type from the **Type** list before clicking . The **Vision** option enables the vision and analysis tools. The **ID** option enables the identification and analysis tools. The **Vision + ID** option enables all tools.



Click  under Folder Location to change the directory for the reference images. The default directory for images is C : \Users\Public\Documents\Banner Vision Manager\VE Series\VE xMP\Images. Both 8-bit monochrome bitmap (BMP) images and inspection logs are supported. Bitmap images should be the same resolution as the VE camera. If inspection logs are placed in the Images directory, the emulator automatically extracts the image out of the inspection log and uses it to run the currently loaded inspection. Click  to open the directory.

The **Emulators** tab includes all available features and all tools function the same as they do when running on a sensor. On the emulator, execution time is not calculated.

11.1 Backup or Restore the Emulator

Emulator settings and inspections can be backed up and restored.

Save the backup file to the location of your choice.

1. From the  **Home** screen, click **Emulators**.
2. Make sure that no sensors or emulators are connected to the Vision Manager software.
3. Click , then click **Backup**.
4. Follow the prompts to save a backup file.
A message displays saying that the backup was successful.
5. To restore the sensor data, click , then click **Restore**.
6. Follow the prompts to restore the sensor data. A sensor backup file can be used to restore the emulator.



Note: This process can take several minutes.

A message displays saying that the restore was successful.

12 Sensor Display

The LCD display on the top of the sensor provides access to view or change several settings without using Vision Manager. The display provides limited programming options:

- **ETHER**—Ethernet settings
- **PCHANGE**—Product change
- **IO**—Input/Output settings
- **IMAGE**—Image settings
- **INFO**—Sensor information
- **SYSERROR**—System errors, if present
- **DISPLAY**—Display settings
- **REBOOT**—Reboot

Access the sensor menu by pressing **Enter**  from the Home Screen on the sensor display.

Note that when User Profiles are enabled, the sensor display is available as read-only. No editing can be done directly from the sensor until User Profiles are disabled for that sensor.

12.1 Sensor Display Interface

Use the sensor buttons to configure several sensor settings and to access sensor information.



Down and Up Buttons

Press **Down** and **Up** to:

- Navigate the menu systems
- Change programming settings

When navigating the menu systems, the menu items loop.



Enter Button

Press **Enter** to:

- Access the Sensor Menu
- Access the submenus
- Save changes

In the Sensor Menu, a check mark  in the lower right corner of the display indicates that pressing **Enter** accesses a submenu.



Escape Button

Press **Escape** to:

- Leave the current menu and return to the parent menu
- Leave the current menu and return to the Home Screen from any menu



Important: Pressing **Escape** discards any unsaved changes.



In the Sensor Menu, a return arrow  in the upper left corner of the display indicates that pressing **Escape** returns to the parent menu.

Press and hold **Escape** for 2 seconds to return to the Home Screen from any menu.

12.2 Locking and Unlocking the Sensor

Use the lock and unlock feature to prevent unauthorized or accidental programming changes.

A lock symbol  displays in the upper left corner of the display to indicate when the sensor is locked. When locked, the menus are available to view settings, but the values cannot be changed.

To lock or unlock the sensor using the buttons, press and hold **Down**  and **Escape**  simultaneously until the lock symbol displays.

12.3 Sensor Menu

Figure 318. Menu Map

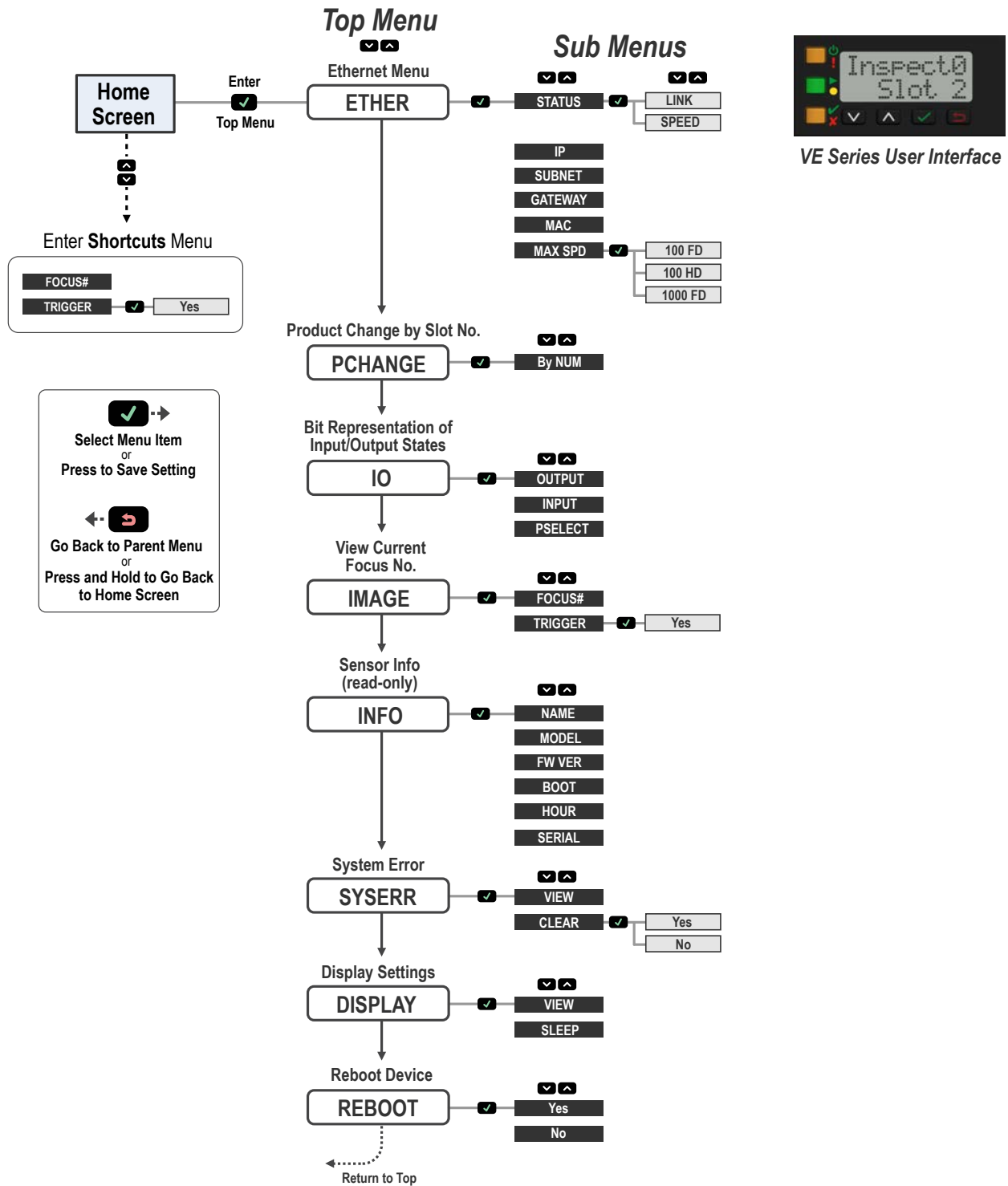

12.4 Ethernet Menu (ETHER)

Use this menu to view or change network connection information.

STATUS

LINK—View the connection status (UP or NONE). UP indicates that an Ethernet link has been established. NONE indicates that a link has not been established.

SPEED—View the speed (100HD/100FD/1000FD).

IP

View or change the IP address of the sensor.

SUBNET

View or change the subnet address of the sensor.

GATEWAY

View or change the gateway address of the sensor.

MAC

View the MAC address of the sensor.

MAX SPEED

Set the speed to 100HD, 100FD, or 1000FD. The default speed is 100 full duplex.



Note: To use 1000 full duplex, all supporting network hardware must fully support 1000 Mb Ethernet or poor communication throughput could occur.

12.5 Product Change Menu (PCHANGE)

Use this menu to view or change the inspection by slot number.

12.6 Input/Output Menu (IO)

Use this menu to view I/O information.

OUTPUT

A Bit representation of the output states.

INPUT

A Bit representation of the input states.

PSELECT

The slot number represented by selected bits and a Bit representation of the Product Select input pins.

12.7 Image Menu (IMAGE)

Use this menu to view focus and trigger information.

FOCUS#

View the current focus number.

TRIGGER

Select **Yes** to trigger the sensor.

12.8 Information Menu (INFO)

Use this menu to view sensor information.

NAME

View the device name.

MODEL

View the model number.

FW VER

View the firmware version.

BOOT

View the boot number.

HOUR

View the hour count.

SERIAL

View the sensor serial number.

12.9 System Error Menu (SYSERR)

Use this menu to view or clear system errors, when present.

VIEW

View the latest system error, when present.

CLEAR

Select **Yes** to clear a system error state. Select **No** to return to the previous menu without clearing the error. Clearing the system error state does not remove the system error from the system log.

12.10 Display Menu (DISPLAY)

Use this menu to change the display orientation and sleep mode settings.

VIEW

View or change the display orientation of the sensor. Invert the display for applications where the device is mounted upside down.

- **Normal**—The display is in the normal orientation
- **Invert**—The display is rotated 180°. The down and up buttons do not change when the display is inverted.

SLEEP

View or change when the display is put to sleep.

- **Disabled**
- **1min**—1 minute
- **5min**—5 minutes (default)
- **15min**—15 minutes
- **60min**—60 minutes

12.11 Reboot Menu (REBOOT)

Use this menu to reboot the sensor. The sensor retains the current settings after the reboot.

Select **Yes** to reboot the sensor. Select **No** to return to the Reboot option without rebooting the sensor.

13 Communications Guide

13.1 Communication Summary

The VE Series camera communicates with other devices via Ethernet.

To establish an Ethernet connection to the sensor, the external device must be configured with the correct IP address and support a communication protocol supported by the sensor.

13.1.1 Communication Channels

The VE Series camera supports up to three communications channels.

To access the channels, go to **System Settings > Communications**.

- Industrial Ethernet—A bi-directional communication channel that allows the user to control the sensor and access sensor results using Ethernet/IP, Modbus/TCP, PROFINET®, or PCCC protocol
- Data Export—Used to export inspection data to a remote device
- Image Export—Used to export inspection images to a remote device

13.1.2 Industrial Ethernet

The VE Series camera can be controlled or monitored over Industrial Ethernet using Ethernet/IP, Modbus/TCP, PROFINET®, or PCCC protocols.

Use this document to set up the VE Series camera in the desired configuration and to provide information needed to connect to the master device (PLC, HMI, etc.).

Navigate: **System Settings > Communications > Industrial Protocols**.

13.1.3 Data Export

Data export is a way to publish inspection data over Ethernet or Serial channels.

Navigate: **System Settings > Communications > Data Export**.

On the **Data Export** tab, set the data export parameters:

Export

Set which results to export:

- Disabled (default)
- All
- Pass only
- Fail only

Channel

Select which channel to use:

- Ethernet (default)
- Serial

Port Number

Set the port number to use for the export. The default is 32100.

Note that the port number cannot be the same as any other port in use.

Hold Ready

During the data export operation the sensor's output channels might become full. This can occur if the sensor is exporting data faster than the data can be exported from the device (due to bandwidth limitations) or faster than the client is reading the channel export data.

The **Hold READY** setting affects how the sensor behaves in this situation.

- Select the **Hold READY** checkbox to prevent new triggers from being accepted until the current results have been exported. This ensures that all results are exported. In this case, the READY signal will remain inactive (sensor is busy) until all the results have been added to the channel for export. Triggers might be missed during this time.
- Clear the **Hold READY** checkbox to accept new triggers while the current results are exported. This causes the sensor to discard the new results if the channel is full and activate the READY signal immediately after the current inspection is complete. In this case, the discarded results will not be exported.



Important: When the checkbox is cleared, not all results will be exported. When the checkbox is selected, the sensor will be busy (not ready) until the result has been written to the network; inspection times will increase based on network throughput.

Use the data export map to select the results to publish. These include:



- Slot
- Tool Type
- Tool Name—The Tool Name must match the tool name included in the inspection for the results to export
- Result—Choose the desired result based on the tool selected







Note: A Slot of ANY means that if an inspection includes a tool with the exact name (for example, *AverageGray01*), the results are output. If an inspection does not have a tool with the exact name (for example *AverageGrayAssemblyLine01*), no results are output for that tool and that inspection.

The Data Type is dependent on the tool selected. Options include the following:

- Boolean (0 or 1)
- Float
- Integer
- String
- HEX

Click  above the map to return the map to the default settings. All user-defined output data is deleted. Click  in the Actions column to delete an individual entry.

Use the data export map to select the results to publish. Use  to add additional entries at the end of the list. Click  or  to add additional entries above or below the currently selected entry. Use  and  to move an entry to either up or down in the map.

Shown below the map is the data that is currently available to be exported.

The Frame Format settings are located to the right of the map:

Delimiter

- , <Comma> (default)
- : <Colon>
- ; <Semicolon>
- \r\n <\x0A\x0D>
- \n\r <\x0D\x0A>
- \r <\x0A>
- \n <\x0D>
- <None>

Start String

Enter the desired start string. The default is none. If desired, enter ASCII hex values for the start string in the format of \xXX. For example, \x0D. Three special characters are available: \r, \n, and \t.

End String

Enter the desired end string. The default is \r\n.



Note: If Data Export is enabled, the receiver application is running under Microsoft Windows, and the sensor is observed experiencing occasional extended not ready states, examine the value of the TCPAckFrequency parameter in the Windows Registry. An incorrect setting of this Windows Registry parameter can cause the sensor to slow down when exporting data to Windows systems. Consult your local IT support personnel with specific questions.

The Missing Data Format settings are also located to the right of the map:

Publish

- None
- Delimiter only (default)
- Fill String

Fill String

Enter the desired content (fill string) to replace the missing data . The default is 0.

Banner Data Export Sample Program

The VE Series camera has a Data Export sample application that provides a way to save exported results. In a production environment, you will need to write your own application to process exported results, for example to display them on an HMI or to save them to disk.

The Banner Data Export Sample Program installs automatically when the Vision Manager software is installed. The source code to write your own application is located at C:\Users\Public\Documents\Banner Vision Manager\Sample Programs\Source\Data Export.

Figure 319. Data Export Sample Application

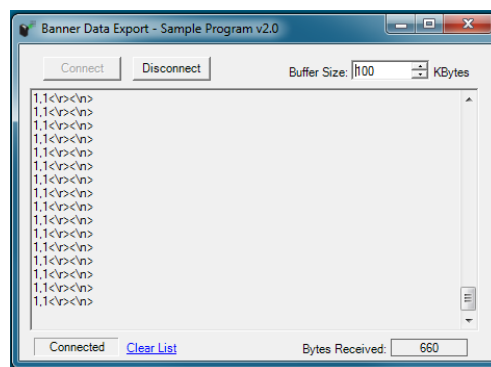

13.1.4 Image Export: TCP/IP

Image export **TCP/IP** is a proprietary TCP/IP protocol that is supported only on Ethernet ports.

Navigate: **System Settings > Communications > Image Export**, select which images to export, and select **TCP/IP** from the **Ethernet Protocol** list.

Image Type

Select the image type to export: BMP or JPEG.

Port Number

Set the port number to use for the export. The default is 32200.

Note that the port number cannot be the same as any other port in use.

Hold READY

During the image export operation the sensor's output channels might become full. This can occur if the sensor is producing export data (images) faster than the data can be exported from the device (due to bandwidth limitations) or faster than the client is reading the channel export data.

The **Hold READY** setting affects how the sensor behaves in this situation.

- Select the **Hold READY** checkbox prevent new triggers from being accepted until the current image has been exported. This ensures that all images are exported. In this case, the READY signal will remain inactive (sensor is busy) until the new image has been added to the channel for export. Triggers might be missed during this time.
- Clear the **Hold READY** checkbox to accept new triggers while the current image is exported. This causes the sensor to discard the new image if the channel is full and activate the READY signal immediately after the current inspection is complete. In this case, the discarded images will not be exported.



Important: When the checkbox is cleared, not all images will be exported. When the checkbox is selected, the sensor will be busy (not ready) until the image has been written to the network; inspection times will increase based on network throughput.

Inspection images match the resolution of the camera and are 8-bits per pixel grayscale images in Windows BMP format that represent all of the data in a full Field of View (FOV).

Each exported image is composed of a header (64 bytes) followed by the image data; see the following tables. All 16- and 32- bit numeric entries are little endian.

Table 5: Header Information

Byte Offset	Field	Size in Bytes	Data Type	Description
0-15	Header Prefix	16	char	"VE IMAGE"
16-19	Header Version	4	UInt32	2
20-23	Image Size	4	UInt32	Number of bytes; see the table below
24-27	Image Frame Number	4	UInt32	Most recently snapped image frame number
28-29	Image Width	2	UInt16	Based on camera resolution
30-31	Image Height	2	UInt16	Based on camera resolution
32-33	Image Format	2	UInt16	0: Bitmap 1: JPEG
34-63	Reserved	30	byte	Reserved for future use

Field of View (FOV)	Image Size (bytes) ⁸
2592 x 2048	5,309,494
1600 x 1200	1,921,078
1280 x 1024	1,311,798
752 x 480	362,038



Note: If Image Export is enabled, the receiver application is running under Microsoft Windows, and the sensor is observed experiencing occasional extended not ready states, examine the value of the TCPAckFrequency parameter in the Windows Registry. An incorrect setting of this Windows Registry parameter can cause the sensor to slow down when exporting images to Windows systems. Consult your local IT support personnel with specific questions.

Banner Image Export Sample Program

The VE Series camera includes an Image Export sample application that provides a way to save exported images. In a production environment, you will need to write your own application to process exported images, for example to display them on an HMI or to save them to disk.

⁸ Windows BMP image. Image size is not fixed for JPEG images (if supported).

The Banner Image Export Sample Program installs automatically when the Vision Manager software is installed. The source code to write your own application is located at C:\Users\Public\Documents\Banner Vision Manager\Sample Programs\Source\Image Export.

Figure 320. Image Export Sample Application



13.1.5 Image Export: FTP

Image Export **FTP** supports exporting images over an FTP connection.

Navigate: **System Settings > Communications > Image Export**, select which images to export, and select **FTP** from the **Ethernet Protocol** list.

Image Type

Select the image type to export: BMP or JPEG.

File Name Format

Set which elements to include in the file names of images that are exported using FTP. Result shows a sample file name. If nothing is selected, the frame number is used as the file name.

- Inspection Pass/Fail—Adds P or F to the file name.
- Device Name—Adds the name of the device to the file name. For example, VE202G21.
- Inspection Slot Number—Adds S# to the file name. For example, S1.
- Inspection Name—Adds the name of the inspection to the file name. For example, Inspection 01.
- Frame Number—Adds N##### to the file name. For example, N1234.
- Custom String—Select and enter the desired text to include in each file name. The maximum number of characters is 100.
- Industrial Protocol String—Adds custom text to the file name from the industrial protocol. The maximum number of characters is 52. See the section on your protocol for information on how to set the custom string (FTP Input String). The string, if available, displays. The string is not saved and cycling the power will delete the string.

To assign the Industrial Protocol string:

1. Make sure that the **FTP Input String** bit on the Input Bits Register is set to 0.
2. Write the desired string length into the **Industrial Protocol Input String Length** area.
3. Write the desired string content into the **Industrial Protocol Input String** area.
4. Set the **FTP Input String** bit to 1 to apply the custom string. After the input string is saved in the system, the **FTP Input String Ack** bit will be set to 1.



Note: The specific industrial protocol must be enabled on the **Industrial Protocols** tab.

For register information and input bits, see the following sections:

- [EtherNet/IP](#) on p. 178
- [Modbus/TCP](#) on p. 198
- [PLC5, SLC500, and MicroLogix \(PCCC\)](#) on p. 207
- [PROFINET](#) on p. 217

This is an example file name that uses most of the **File Name Format** options: PVE202G21S1Inspection 01N1234.bmp. This example does not include any custom strings or industrial protocol strings.

Hold READY

During the image export operation the sensor's output channels might become full. This can occur if the sensor is producing export data (images) faster than the data can be exported from the device (due to bandwidth limitations) or faster than the client is reading the channel export data.

The **Hold READY** setting affects how the sensor behaves in this situation.

- Select the **Hold READY** checkbox prevent new triggers from being accepted until the current image has been exported. This ensures that all images are exported. In this case, the READY signal will remain inactive (sensor is busy) until the new image has been added to the channel for export. Triggers might be missed during this time.
- Clear the **Hold READY** checkbox to accept new triggers while the current image is exported. This causes the sensor to discard the new image if the channel is full and activate the READY signal immediately after the current inspection is complete. In this case, the discarded images will not be exported.



Important: When the checkbox is cleared, not all images will be exported. When the checkbox is selected, the sensor will be busy (not ready) until the image has been written to the network; inspection times will increase based on network throughput.

Result

Displays the image export result as well as the name of the file being exported.

Inspection images match the resolution of the camera and are 8-bits per pixel grayscale images in Windows BMP format that represent all of the data in a full Field of View (FOV).

Field of View (FOV)	Image Size (bytes) ¹⁰
2592 x 2048	5,309,494
1600 x 1200	1,921,078
1280 x 1024	1,311,798
752 x 480	362,038

The **FTP Server Settings** are empty by default. The settings must be set before you run an Image Export using FTP server.

IP Address

The IP address of the user's FTP server.

Port Number

The port number required to access the FTP server.

User Name

The user name required to access the FTP server.

Password

The user's password used to access the FTP server.

Folder Name

Enter a folder name to save the exported images to a specific user-created folder on the FTP server. If the **Folder Name** field is:

- blank—images are saved to the root folder
- *foldername1*—images are saved in [*foldername1*] under the root folder
- *foldername1/foldername2*—images are saved in [*foldername2*] under the [*foldername1*] folder

Passive Mode

A connection mode defined by the official FTP protocol in which the client establishes the command channel and the data channel. The server tells the client which port should be used for the data channel.

Connection Mode

Just in time—Select to connect to the FTP server each time an image is sent. This option limits network bandwidth.

Always connected—Select to keep the connection to the FTP server active at all times.

Status

Displays status messages regarding the FTP connection.

¹⁰ Windows BMP image. Image size is not fixed for JPEG images (if supported).

13.1.6 Input String: TCP/IP

Input String is a way for the sensor to receive data from a TCP/IP Client.

The data received as an Input String is then an available result data item that can be added to the Data Export map. This can be used to annotate result data with an identifier, to signify what inspection or part the results are from.

Navigate:  **System Settings > Communications > Input String.**

On the **Input String** tab, set the parameters:

Input String

Enable the **Input String** so that the sensor can receive data over the defined Ethernet port.

Port Number

Set the port number to use for communication. The default is 32300.

Note that the port number cannot be the same as any other port in use.

String Header

The character array that defines the beginning of a valid string. Maximum size is 25 characters.

The header is optional.

To use non-printable ASCII characters, use the format `\xYY` where “YY” is the hexadecimal representation of any ASCII character.

The default value for the Header is `\x02`.

String Footer

The character array that defines the end of a valid string. Maximum size is 25 characters.

The footer is required.

To use non-printable ASCII characters, use the format `\xYY` where “YY” is the hexadecimal representation of any ASCII character.

The default value for the Header is `\x03`.

Use as a trigger source

Select the **Use as a trigger source** checkbox to use a valid input string to trigger the sensor.



Note: If **Use as a trigger source** is checked, valid input strings are ignored if the READY signal is inactive.

The maximum size, including the header, content, and footer, is 50 bytes.

Examples

Example 1:

Header : none

Footer: End\x03

User supplied data: Banner EngineeringEnd\x03

Extracted String: Banner Engineering

Example 2:

Header : \x02Start

Footer: End\x03

User supplied data: \x02StartBanner EngineeringEnd\x03

Extracted String: Banner Engineering

Example 3:

Header : \x02

Footer: \x03

User supplied data: \x02Test\x02Banner Engineering\x03Test\x03

Extracted String: Banner Engineering

13.2 Enabling Communications

13.2.1 Setting Up Ethernet Communications

Configure the PC to communicate with the sensor using the following instructions.

13.2.2 Windows 7

1. On the Windows 7 ¹¹ PC, click the **Start** button, then on the **Start** menu, click **Control Panel**.
2. In **Control Panel**, click **Network and Internet**, then click **Network and Sharing Center**, and then click **Change adapter settings**.
3. Right-click on the connection that you want to change, then click **Properties**.
If you are prompted for an administrator password or confirmation, enter the password or provide confirmation.
4. In the connection properties, click **Internet Protocol Version 4 (TCP/IPv4)**, and then click **Properties**.

Figure 321. Local Area Connection Properties Screen

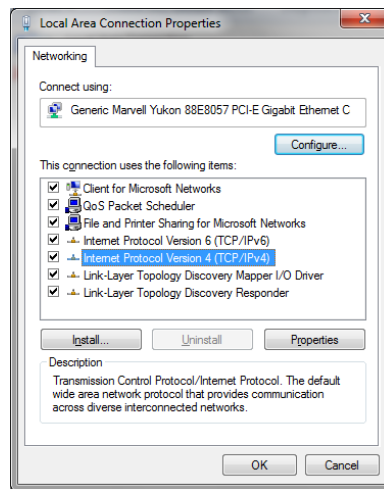

5. In **Internet Protocol (TCP/IPv4) Properties**, select **Use the following IP address**.
6. Make sure that the IP address is 192.168.0.2, and the subnet mask is 255.255.255.0.

Figure 322. Internet Protocol (TCP/IPv4) Properties Screen

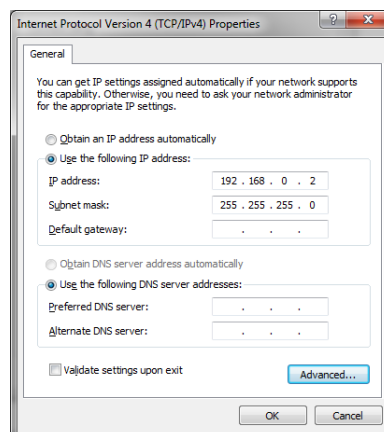

13.2.3 Communications Channel Ports

The default Ethernet port setting for the communication channels is: Image Export—32200 and Data Export—32100.

¹¹ Microsoft and Windows are registered trademarks of Microsoft Corporation in the United States and/or other countries.

14 Industrial Ethernet Overview

14.1 Industrial Ethernet Setup

14.1.1 Set the Industrial Ethernet Protocol (EtherNet/IP™, PROFINET®, Modbus/TCP, PCCC)

The Industrial Ethernet communication channel is disabled by default.

To enable this channel, use the following instructions:

1. From the  **System Settings** screen, click **Communications**, then click **Industrial Protocols**.
2. Select the desired protocol from the list.
 - Disabled (default)
 - EtherNet/IP
 - PROFINET
 - Modbus/TCP
 - PCCC

Only one type of connection can be established at a time.

3. Select the desired **32 Bit Format** from the list.

32 bit Format determines how 32 bit integers and floating point values are stored in sequential 16 bit registers (words) —least significant word first (LSW-MSW) or most significant word first (MSW-LSW).

Word	Value
0	LSW
1	MSW

OR

Word	Value
0	MSW
1	LSW



Note: To configure the tool-specific results, see:

- [Tool-Specific Results: EtherNet/IP](#) on p. 184
- [Tool-Specific Results: Modbus/TCP](#) on p. 205
- [Tool-Specific Results: PCCC](#) on p. 216
- [Tool-Specific Results: PROFINET](#) on p. 224

14.1.2 Set the Trigger Mode

Trigger the sensor using either the hardware trigger or through the Industrial Ethernet.

To only accept triggers generated through the Industrial Ethernet communication channel, set the trigger to Industrial Ethernet.



Note: An Industrial Protocol must be enabled from **System Settings > Communications > Industrial Protocols** before setting the trigger to Industrial Ethernet.

1. On the  **Sensor** screen, click the **Camera** tool.
The **Inputs** tab displays.
2. On the Inputs tab, expand **Trigger**.
3. Select **Industrial Ethernet** from the **Trigger Mode** list.

14.2 Supported Functions

The VE Series camera is controlled over an Industrial Ethernet connection using the input and output data it makes available over the protocol.

The following are examples of sensor functions that can be performed using input and output values:

- Product change
- Remote teach (Match and Barcode tools)
- Sensor trigger
- Read output indicators (pass/fail/ready/error)
- Read counters (pass, fail, error code, missed trigger, frame count, inspection time)
- FTP filename string
- Barcode Data Compare String



Note: If an input or an output register or a bit is marked as Reserved, its value at any time is indeterminate.

14.2.1 Sensor Input Values

The VE Series camera operation can be controlled through input bits.

Table 6: Input Bits

The following commands can be executed only using bits.

Input Coil Bit	Command	Description
0	Product Change	Execute a product change (the inspection number specified in the "Product Change Number" 32-bit integer register)
1	Teach Latch	Latch a teach bit; the Teach is executed on the next trigger
2	Trigger	Causes the system to trigger an inspection if ready

14.2.2 Sensor Output Values

The following information can be obtained using output values:

- ACK bits (acknowledgement bits) for input commands, including error codes
- System indicators (Ready, Pass/Fail, Output signals, Execution Error, etc.)
- Inspection History (Iteration Count, Pass Count, Fail Count, etc.)
- Sensor Pass/Fail Bits (Indications of whether each tool in the inspection passed or failed, individually)

See the section on protocols for more information.

ACK Bits

For each of the input bits there is a corresponding ACK bit. The vision sensor sets the ACK bit when the corresponding action is complete. Input bits cause actions to occur on the low-to-high transition of that bit.



Important: You must clear the input bit after the corresponding ACK bit has been observed to be high.

As an example, to use the Trigger ACK bit, the programming steps for triggering an inspection are:

1. Wait for ready.
2. Set Trigger input bit to 1.
3. Wait for Trigger ACK to go to 1.
4. Set Trigger input bit to 0.

14.3 EtherNet/IP™

In this context, references to EtherNet/IP™¹³ refer specifically to EtherNet/IP transport class 1. Sometimes referred to as cyclic EtherNet/IP IO data transfer or implicit messaging, this connection is meant to approximate a real-time data transfer to and from the PLC and the target device.

Allen-Bradley's CompactLogix and ControlLogix family of PLCs uses this communication protocol. The programming software used by these PLCs is RSLogix5000 or Studio 5000 Logix Designer.

The VE Series camera is controlled via EtherNet/IP using assembly objects. From the point of view of a PLC, there are three input assemblies and two output assemblies.

The Originator of the EtherNet/IP connection is the PLC. The Target of the EtherNet/IP connection is the VE Series camera. The direction of communication can be described as T > O or O > T (sometimes also shown as T2O or O2T).

¹³ EtherNet/IP™ is a trademark of ODVA, Inc.

The following rules apply for the use of input bit commands:

- Only one VE Series camera input bit can be set at a time
- Corresponding ACK bits are set high only on completion of the command (if the VE input bit is still high)
- Corresponding ACK bits are cleared when the VE input bit is cleared
- When multiple VE input bits are set simultaneously, the Execution Error input bit is set and an Error Code value is reported in the Error Code register
- The Execution Error VE output bit is cleared when all ACK bits are cleared, or a new valid command is received

Figure 323. Trigger—Modbus/TCP, EtherNet/IP, PCCC

Figure 324. Trigger Timing Diagram

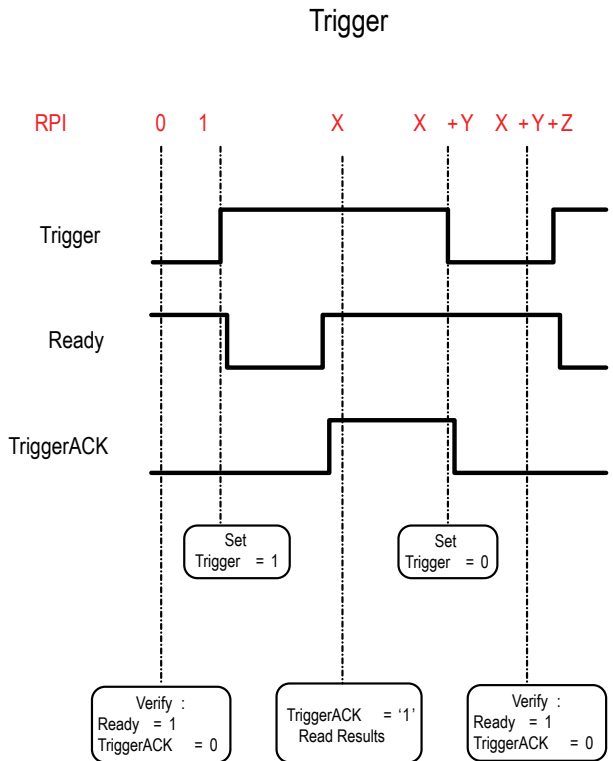
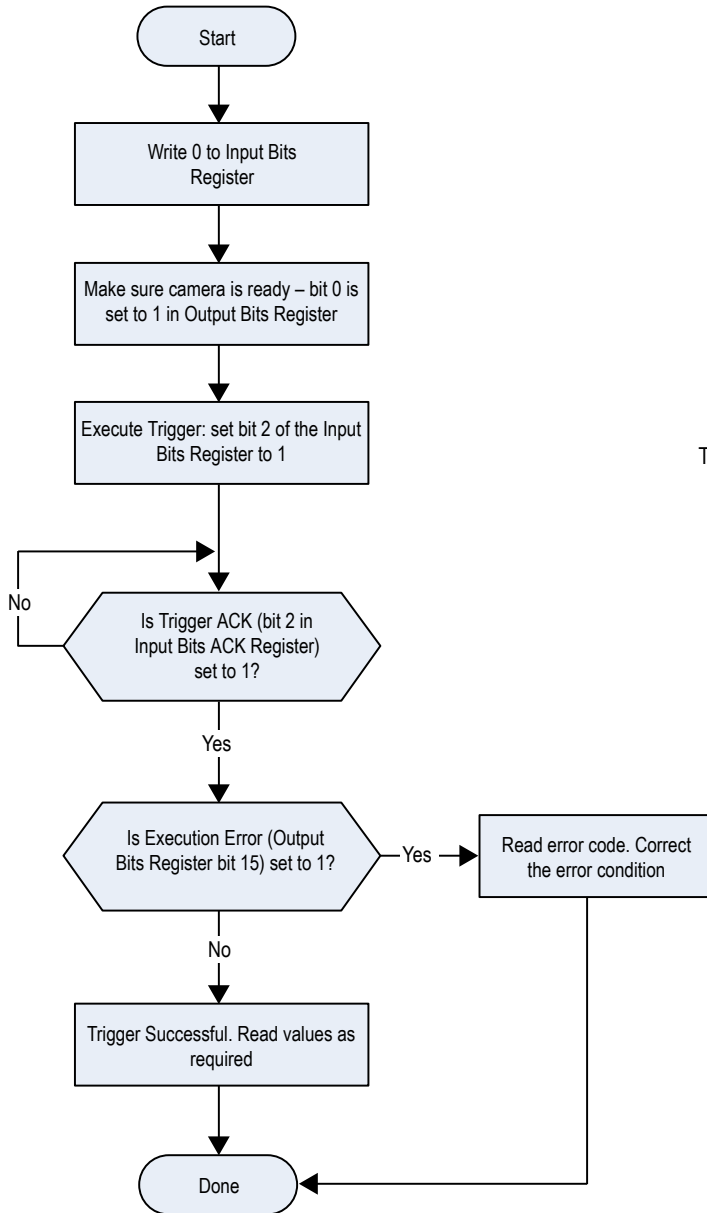

X, Y, Z: Represent snapshots in time

Figure 325. TEACH—Modbus/TCP, EtherNet/IP, PCCC

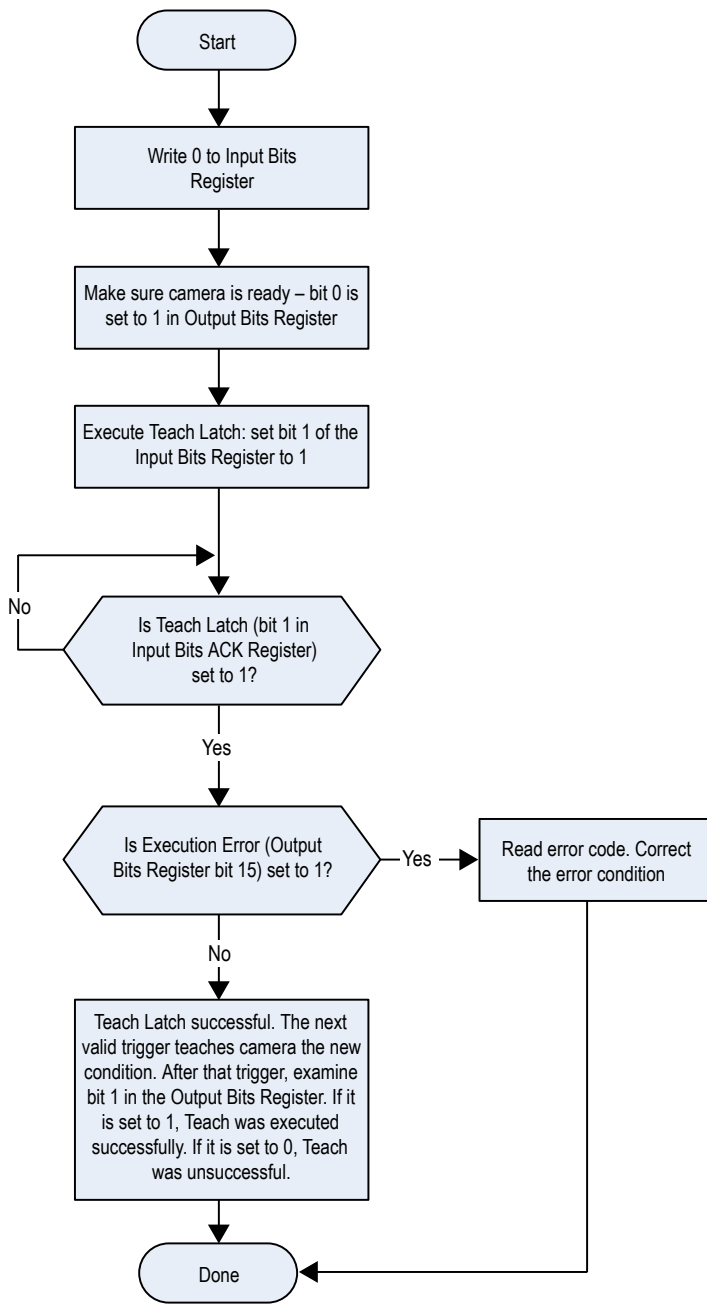

Figure 326. Teach Latch Timing Diagram

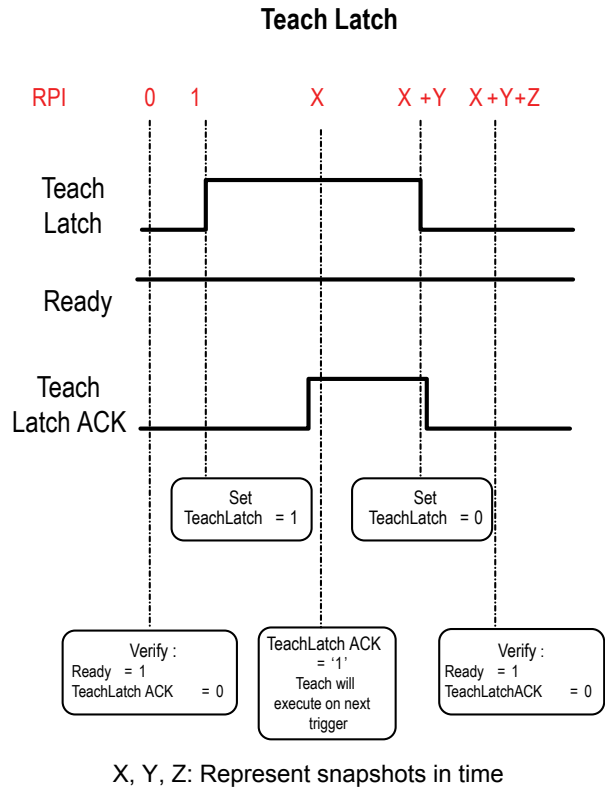

Figure 327. Product Change—Modbus/TCP, EtherNet/IP, PCCC

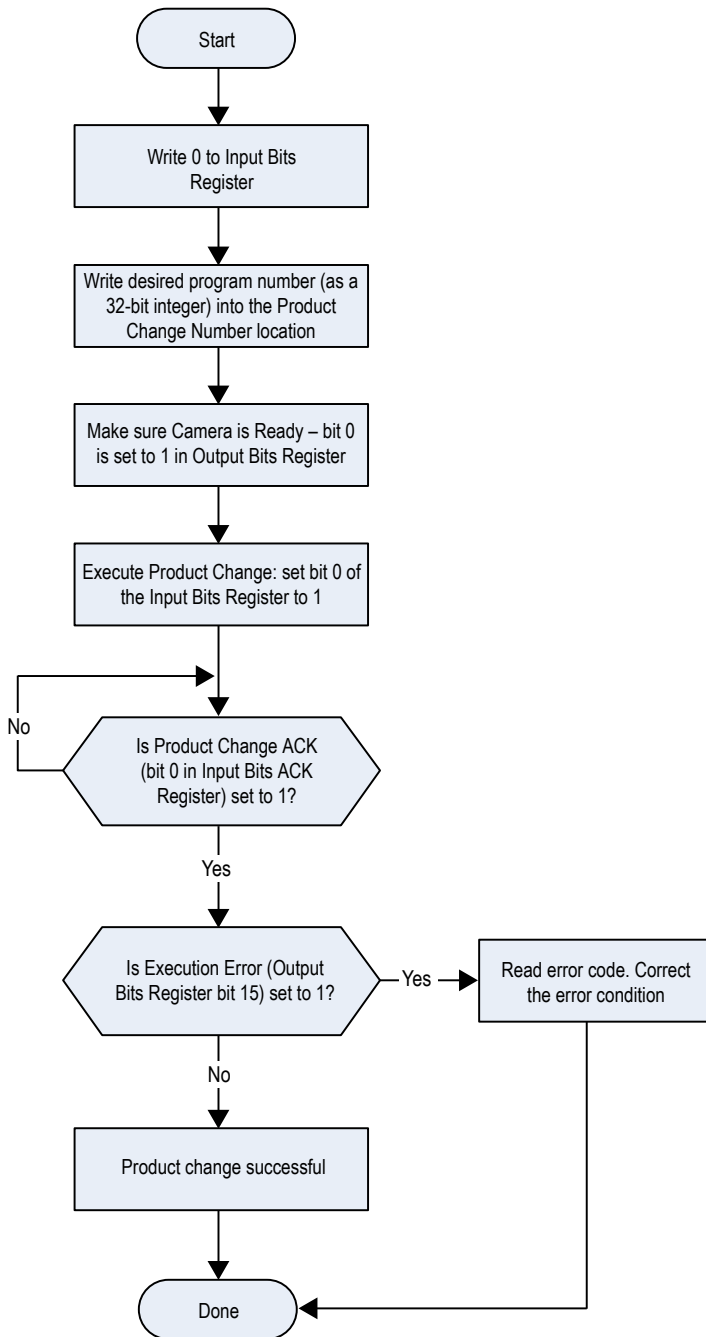
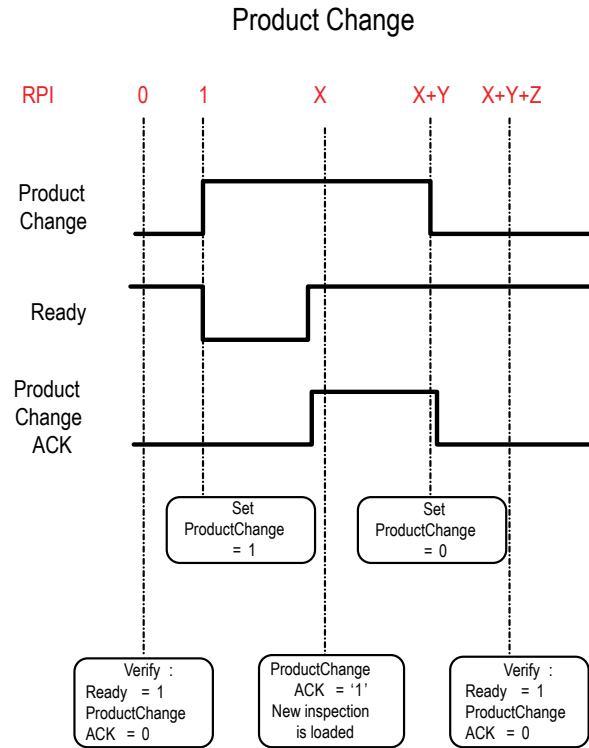

Figure 328. Product Change Timing Diagram



X, Y, Z: Represent snapshots in time

14.3.1 Inputs to the Sensor (Outputs from the PLC)

PLC Assembly Instance 112 (0x70) - 6 Registers (Sensor Inputs/PLC Outputs)

O > T

Data transfer direction: Originator (PLC) to Target (VE). Assembly Instance 112 (0x70) is a small group of registers used for basic control of the VE Series camera.

WORD #	WORD NAME	DATA TYPE
0	Input Bits Register (see Input and Output Bits on p. 183)	16-bit integer
1-2	Product Change Number	32-bit integer
3-5	<i>reserved</i>	16-bit integer

PLC Assembly Instance 117 (0x75) - 34 Registers (Sensor Inputs/PLC Outputs) O > T

Data transfer direction: Originator (PLC) to Target (VE). Assembly Instance 117 (0x75) is a group of registers used for sending input strings to the VE.

To use this Assembly Instance for FTP Filename control, the **Industrial Protocol String** checkbox must be selected. See [Image Export: FTP](#) on p. 173.

To use this Assembly Instance for setting the Barcode Data Compare String, the **Data Compare** checkbox on the **Test** tab must be selected. See [Barcode Tool: Test Parameters](#) on p. 145.

WORD #	WORD NAME	DATA TYPE
0	Input Bits Register (see Input and Output Bits on p. 183)	16-bit integer
1-2	Product Change Number	32-bit integer
3-4	<i>reserved</i>	16-bit integer
5	Input String Tool Index	16-bit integer
6-7	Input String Length	32-bit integer
8-33	Input String	String (52 characters)

14.3.2 Outputs from the Sensor (Inputs to the PLC)

PLC Assembly Instance 100 (0x64) - 30 Registers (Sensor Outputs/PLC Inputs) T > O

Data transfer direction: Target (VE) to Originator (PLC). Assembly Instance 100 (0x64) is a small block of registers providing basic inspection results and 13 user-configurable registers for tool-specific results from the VE Series camera.

WORD #	RESULT	DATA TYPE
0	Input Bits ACK Register (see Input and Output Bits on p. 183)	16-bit integer
1	Output Bits Register (see Input and Output Bits on p. 183)	16-bit integer
2-3	Error Code	32-bit integer
4-5	Inspection Number	32-bit integer
6-7	Frame Count	32-bit integer
8-9	Pass Count	32-bit integer
10-11	Fail Count	32-bit integer
12-13	Missed Triggers	32-bit integer
14-15	Current Inspection Time	32-bit float
16	Sensor Pass/Fail Bits (see Sensor Pass/Fail Bits on p. 184)	16-bit integer
17-29	User-defined (see Tool-Specific Results: Ethernet/IP on p. 184)	Selection dependent

PLC Assembly Instance 101 (0x65) - 240 Registers (Sensor Outputs/PLC Inputs) T > O

Data transfer direction: Target (VE) to Originator (PLC). Assembly Instance 101 (0x65) is a large block of registers that provides both basic inspection results and 223 user-configurable registers for tool-specific results.

WORD #	WORD NAME	DATA TYPE
0	Input Bits ACK Register (see Input and Output Bits on p. 183)	16-bit integer
1	Output Bits Register (see Input and Output Bits on p. 183)	16-bit integer
2-3	Error Code	32-bit integer
4-5	Inspection Number	32-bit integer
6-7	Frame Count	32-bit integer
8-9	Pass Count	32-bit integer
10-11	Fail Count	32-bit integer
12-13	Missed Triggers	32-bit integer
14-15	Current Inspection Time	32-bit float
16	Sensor Pass/Fail Bits (see Sensor Pass/Fail Bits on p. 184)	16-bit integer
17-239	User-defined (see Tool-Specific Results: EtherNet/IP on p. 184)	Selection dependent

PLC Assembly Instance 102 (0x66) - 60 Registers (Sensor Outputs/PLC Inputs) T > O

Data transfer direction: Target (VE) to Originator (PLC). Assembly Instance 102 (0x66) is a large block of registers that provides both basic inspection results and 43 user-configurable registers for tool-specific results.

WORD #	WORD NAME	DATA TYPE
0	Input Bits ACK Register (see Input and Output Bits on p. 183)	16-bit integer
1	Output Bits Register (see Input and Output Bits on p. 183)	16-bit integer
2-3	Error Code	32-bit integer
4-5	Inspection Number	32-bit integer
6-7	Frame Count	32-bit integer
8-9	Pass Count	32-bit integer
10-11	Fail Count	32-bit integer
12-13	Missed Triggers	32-bit integer
14-15	Current Inspection Time	32-bit float
16	Sensor Pass/Fail Bits (see Sensor Pass/Fail Bits on p. 184)	16-bit integer
17-59	User-defined (see Tool-Specific Results: EtherNet/IP on p. 184)	Selection dependent

14.3.3 Input and Output Bits

Table 7: Input Bits Register (Command Bits)

Bit Position															
15	14	13	12	11	10	9	8	7	6	5	4	3	2	1	0
reserved	reserved	reserved	reserved	reserved	reserved	reserved	reserved	FTP Input String	Barcode Data Compare Input String	reserved	reserved	reserved	Trigger	Teach Latch	Product Change

Table 8: Input Bits ACK Register (ACK Bits)

Bit Position															
15	14	13	12	11	10	9	8	7	6	5	4	3	2	1	0
reserved	reserved	reserved	reserved	reserved	reserved	reserved	reserved	FTP Input String ACK	Barcode Data Compare Input String ACK	reserved	reserved	reserved	Trigger ACK	Teach Latch ACK	Product Change ACK

Table 9: Output Bits Register (Sensor Status Bits)

Bit Position															
15	14	13	12	11	10	9	8	7	6	5	4	3	2	1	0
Execution Error	System Error	Teach Error	Missed Trigger	reserved	reserved	Output 5	Output 4	Output 3	Output 2	Output 1	reserved	Ready Latch	reserved	Pass/Fail	Ready

14.3.4 Sensor Pass/Fail Bits

For the sensor pass/fail bits, pass = 1 and fail = 0.

Table 10: Sensor Pass/Fail Bits

Bit Position															
15	14	13	12	11	10	9	8	7	6	5	4	3	2	1	0
Vision Tool 15 Pass/Fail	Vision Tool 14 Pass/Fail	Vision Tool 13 Pass/Fail	Vision Tool 12 Pass/Fail	Vision Tool 11 Pass/Fail	Vision Tool 10 Pass/Fail	Vision Tool 9 Pass/Fail	Vision Tool 8 Pass/Fail	Vision Tool 7 Pass/Fail	Vision Tool 6 Pass/Fail	Vision Tool 5 Pass/Fail	Vision Tool 4 Pass/Fail	Vision Tool 3 Pass/Fail	Vision Tool 2 Pass/Fail	Vision Tool 1 Pass/Fail	Camera Tool Pass/Fail

14.3.5 Tool-Specific Results: EtherNet/IP

Configure the VE to output user-defined, tool-specific results to the PLC using a custom map.

Each assembly instance includes system-defined and user-defined results in the map. To set the user-defined, tool-specific results in the custom map, navigate: **System Settings > Communications > Industrial Protocols**.

Figure 329. Industrial Protocols Tab—EtherNet/IP

Protocol: EtherNet/IP
32 Bit Format: LSW-MSW

Create a custom map by adding tool specific results in the table below.
NOTE: Items marked with are fixed and filled with the most current data.

WORD #	Inspection #	Tool Type	Tool Name	Result	Data Type	Actions
0	ANY	—	System Values	Input Bits ACK Register	16-bit integer	
1	ANY	—	System Values	Output Bits Register	16-bit integer	
2 - 3	ANY	—	System Values	Error Code	32-bit integer	
4 - 5	ANY	—	Inspection Values	Slot Number	32-bit integer	
6 - 7	ANY	—	Inspection Values	Frame Number	32-bit integer	
8 - 9	ANY	—	Inspection Values	Passed	32-bit integer	
10 - 11	ANY	—	Inspection Values	Failed	32-bit integer	
12 - 13	ANY	—	Inspection Values	Missed Triggers	32-bit integer	
14 - 15	ANY	—	Inspection Values	Execution Time	32-bit float	
16	ANY	—	Inspection Values	Tool Pass Fail Result Coil	16-bit integer	
17	1		Camera01	Pass	16-bit boolean	
18 - 19	1		AverageGray01	Average Grayscale	32-bit float	
+						
23 - 24	1		Measure01	Distance X	32-bit float	
25 - 26	ANY		Match01	Match[1].Percentage	32-bit float	
27	2		Camera01	Pass	16-bit boolean	
+						

PLC Input/Sensor Output Assemblies:
100 (0x64) - 30 Registers
101 (0x65) - 240 Registers
102 (0x66) - 60 Registers

Press this button for changes to take effect on the camera.

Apply Changes

The results are configurable only for the current inspection. However, all user-defined results in the custom map are shown on the Industrial Protocols tab whether or not they are included in the current inspection. To make changes to a different inspection, switch to the desired inspection and then make changes to the custom map. Updating the map does not disconnect the sensor from the PLC.

To configure the map:

1. Click to add a new line to the map.
2. Set the Word/Register/Byte, Tool Name, and Result. See the following descriptions for more information.
3. Click **Apply Changes** to send the current map to the camera.



Important: Click **Apply Changes** or all user-defined data is lost when you click away from the **Industrial Protocols** tab.

4. Click to print and save a PDF of the current map. The PDF includes all data, whether system-defined or user-defined.
5. To return the map to the default settings, click . All user-defined output data is deleted.

Column descriptions:

WORD

The data location.

Inspection

Shows whether this tool result applies to the current inspection only (*inspection number*) or to any inspection (ANY) that includes the selected tool.

An Inspection # of ANY means that if an inspection includes a tool with the exact name (for example, *AverageGray01*), the results are output. If an inspection does not have a tool with the exact name (for example *AverageGrayAssemblyLine01*), no results are output for that tool and that inspection.

Tool Type

Displays a graphic that represents the type of tool selected in the Tool Name column.

Tool Name

Select the desired Tool Name from the list. The list includes the tools available in the current inspection only. Select a different inspection from the inspection list, if necessary.

Result

The information to output.

Data Type

The type of information to output.

Actions

Click  to delete a result. You cannot delete system-defined results that contain the  symbol.

14.3.6 Configuration Assembly Object

The VE Series camera EtherNet/IP implementation does not support an assembly object Configuration instance. However, one is required for the creation of implicit Class 1 connections on a ControlLogix^{®19} family PLC. Therefore, a configuration instance is defined as instance number 128 (0x80). Its size is zero.

14.3.7 Data Formats

The VE Series camera EtherNet/IP implementation supports 32-bit integers in LSW_MSW data format (default) or MSW_LSW data format. The LSW_MSW data format is such that the least significant word is stored first, then the most significant word. This format is used for Allen-Bradley ControlLogix PLCs.

The string format is compatible with the Allen-Bradley ControlLogix built-in string data type. This format is a 32 bit (DINT) length followed by character bytes (SINT). This results in the following string format as viewed from the VE Series camera:

	0	1	2		3		4			
Word	Length LSW	Length MSW	byte 1	byte 0	byte 3	byte 2	byte 5	byte 4

14.3.8 Minimum Requested Packet Interval (RPI) Value

The VE Series camera can operate with input and output Requested Packet Intervals (RPis) as low as 50 milliseconds. **The device may not operate reliably if a lower RPI value is selected.**

14.3.9 VE Series Smart Camera EDS File Installation in ControlLogix Software

Use the **EDS Hardware Installation Tool** to register the Electronic Data Sheet (EDS) file.

1. On the **Tools** menu, click **EDS Hardware Installation Tool**. The **Rockwell Automation's EDS Wizard** dialog displays.

Figure 330. Tools—EDS Hardware Installation Tool

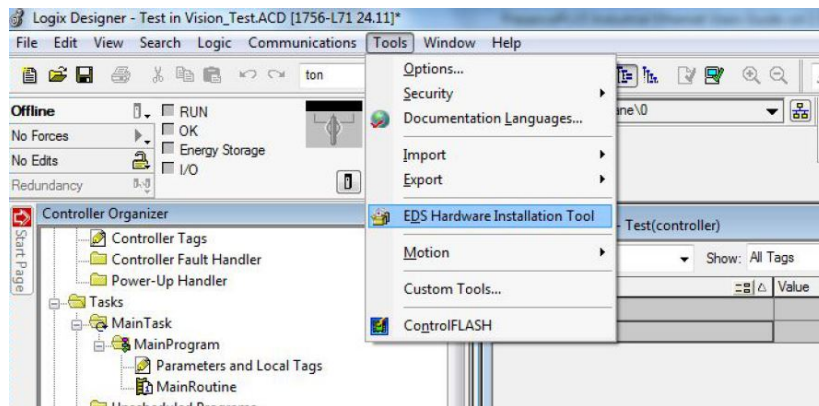

¹⁹ ControlLogix[®] is a trademark of Rockwell Automation, Inc.

2. Click **Next**.
3. Select the **Register an EDS file(s)** option.

Figure 331. Rockwell Automation's EDS Wizard—Options



4. Browse to locate the EDS file and click **Next**.
If Vision Manager is installed on the computer, a copy of the EDS file is available at C:\Users\Public\Documents \Banner Vision Manager\VE Series\Industrial Protocols\EthernetIP.

Figure 332. Select File to Register

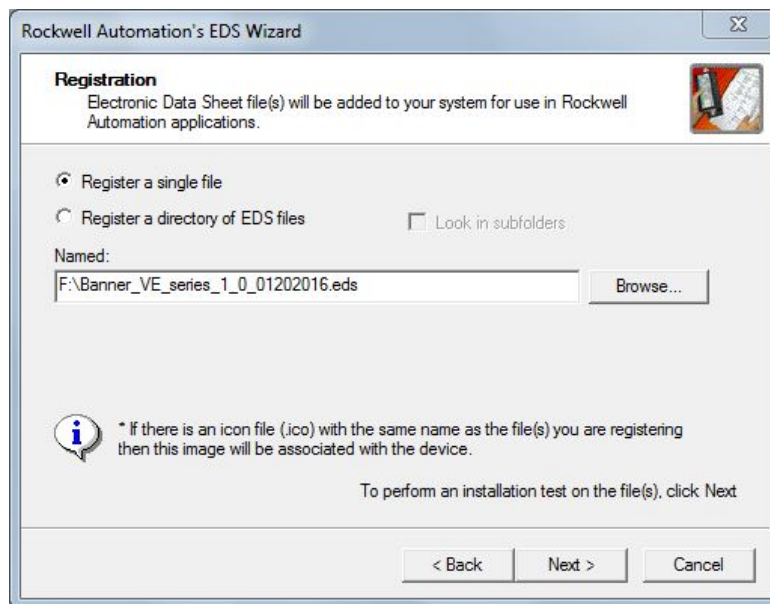

5. Click **Next** to register the tested file.

Figure 333. Register the Tested File

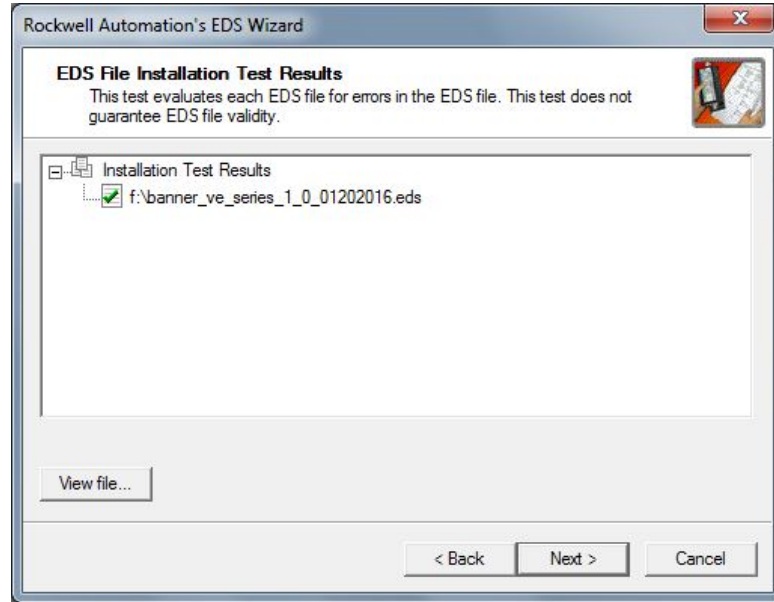

6. Click **Next** when you see the icon associated with the EDS file.

Figure 334. Rockwell Automation's EDS Wizard

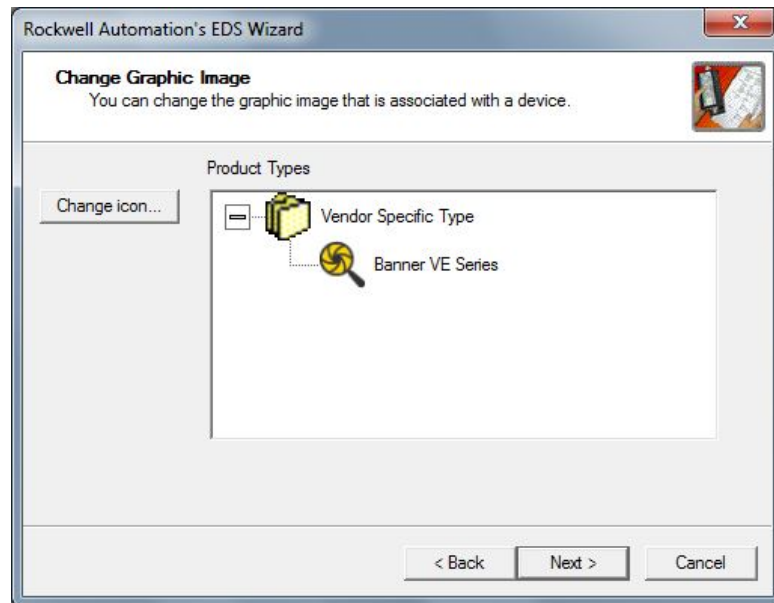

7. Click **Next** to register the EDS file.

Figure 335. Register the EDS File

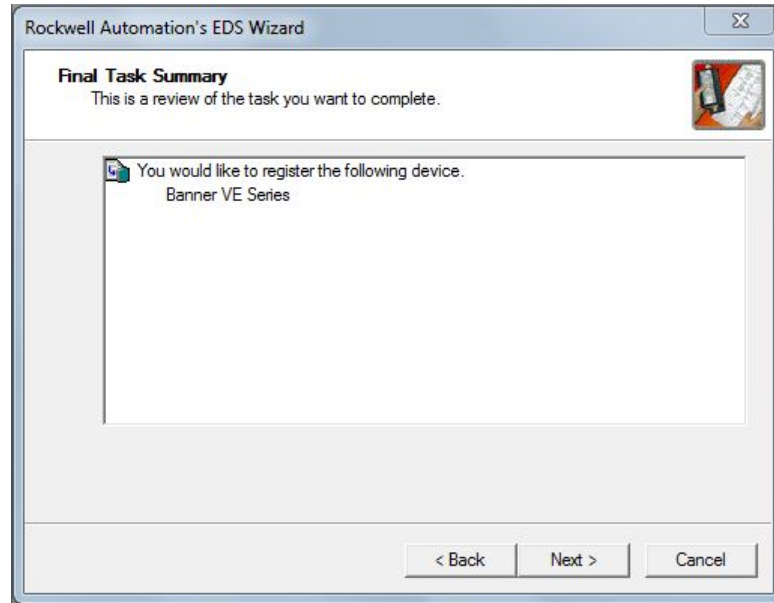

8. Click **Finish** to close the **EDS Wizard** .
9. Right-click on the PLC's Ethernet adapter and select **New Module...**

Figure 336. New Module

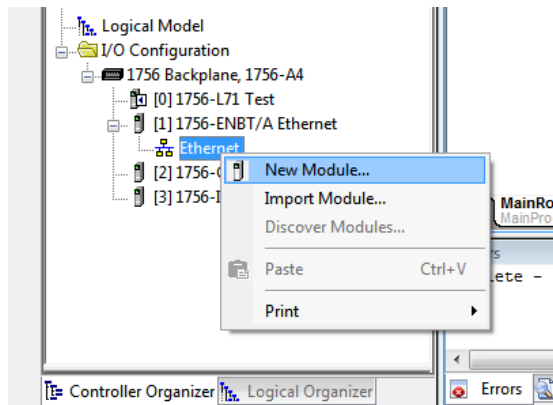

10. Locate the device in the catalog and click **Create**.

Figure 337. Select Module Type

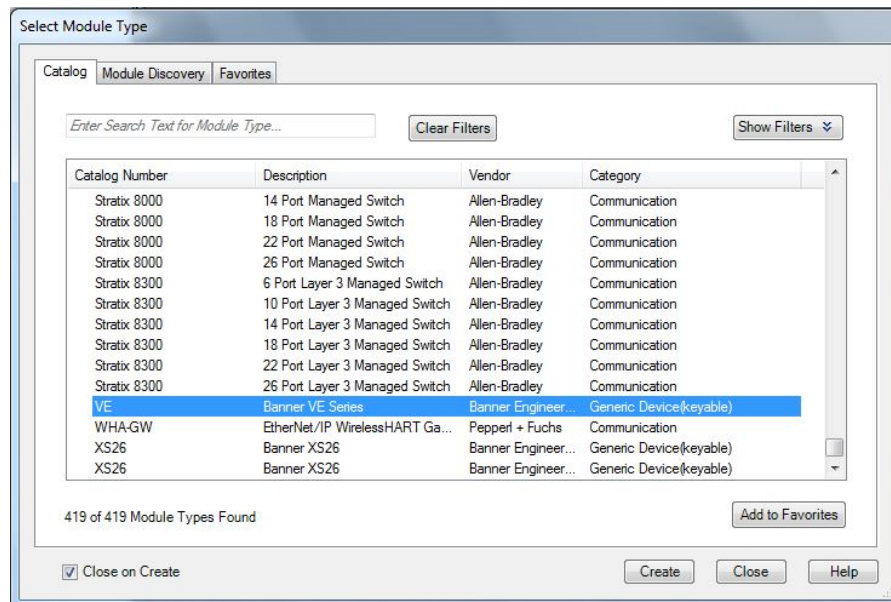

11. Enter a name, description (optional), and IP address for the device.

Figure 338. New Module

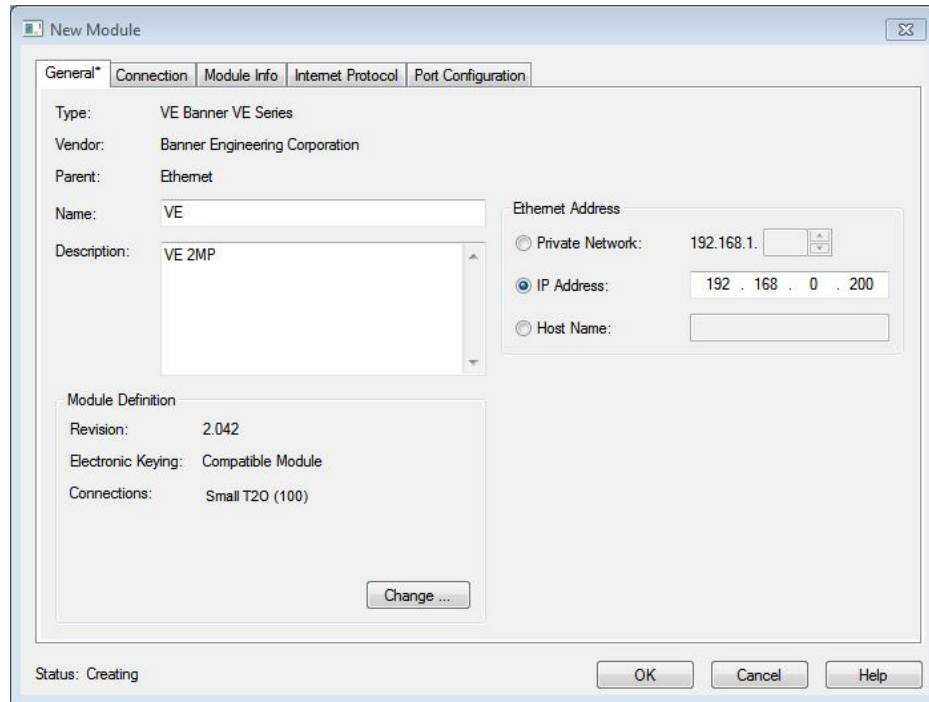

12. Click **Change** in the **Module Definition** field.

Figure 339. Module Definition

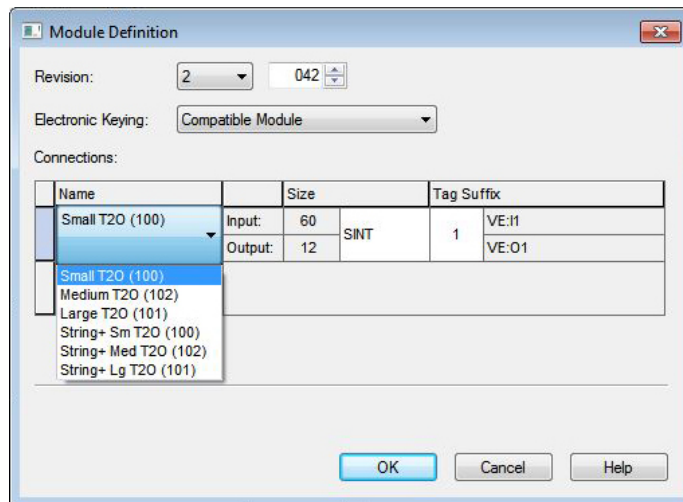

13. Select the desired connection in the **Module Definition** window. Each of the items in the **Name** list represents a fixed grouping of input and output assembly instances:

Small T20 (100)

- O>T PLC/Sensor Assembly 112 (0×70)
- T>O PLC/Sensor Assembly 100 (0×64)

Medium T20 (102)

- O>T PLC/Sensor Assembly 112 (0×70)
- T>O PLC/Sensor Assembly 102 (0×66)

Large T20 (101)

- O>T PLC/Sensor Assembly 112 (0×70)
- T>O PLC/Sensor Assembly 101 (0×65)

String + Small T20 (100)

- O>T PLC/Sensor Assembly 117 (0×75)
- T>O PLC/Sensor Assembly 100 (0×64)

String + Medium T20 (102)

- O>T PLC/Sensor Assembly 117 (0×75)
- T>O PLC/Sensor Assembly 102 (0×66)

String + Large T20 (101)

- O>T PLC/Sensor Assembly 117 (0×75)
- T>O PLC/Sensor Assembly 101 (0×65)

14. Select **INT** as the data type.

Figure 340. Module Definition—Data Type

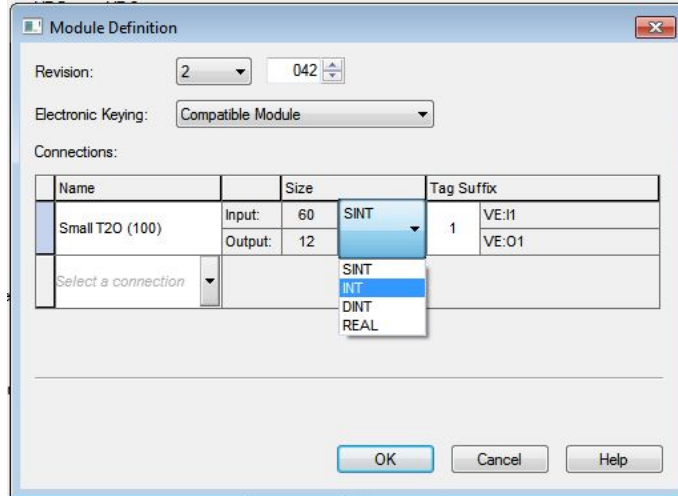

15. Click **OK** twice and download the program to the PLC.

Figure 341. Download to the PLC

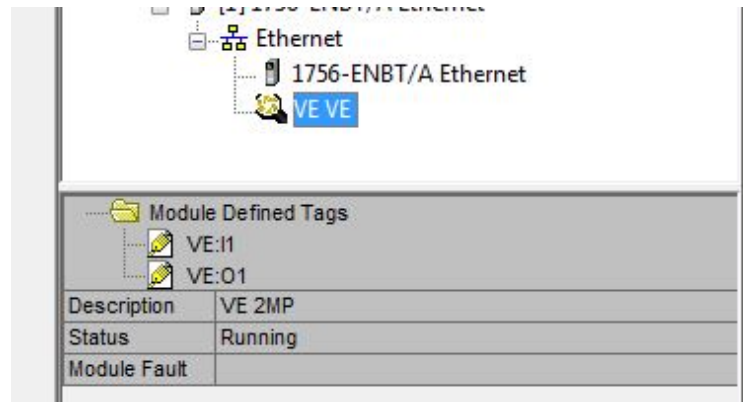

The connection looks like the one in [Figure 341](#) on p. 191.

14.3.10 RSLogix5000 Configuration

To create an implicit Class 1 configuration to the VE Series camera using EtherNet/IP when using a ControlLogix family PLC, configure the VE as a “Generic Ethernet Module” under the ENET_MODULE. The following is a sample setup of a Banner device:

1. Add a generic Ethernet module to the PLC’s Ethernet card.
 - a. Click **New Module**.

Figure 342. Add Ethernet Module

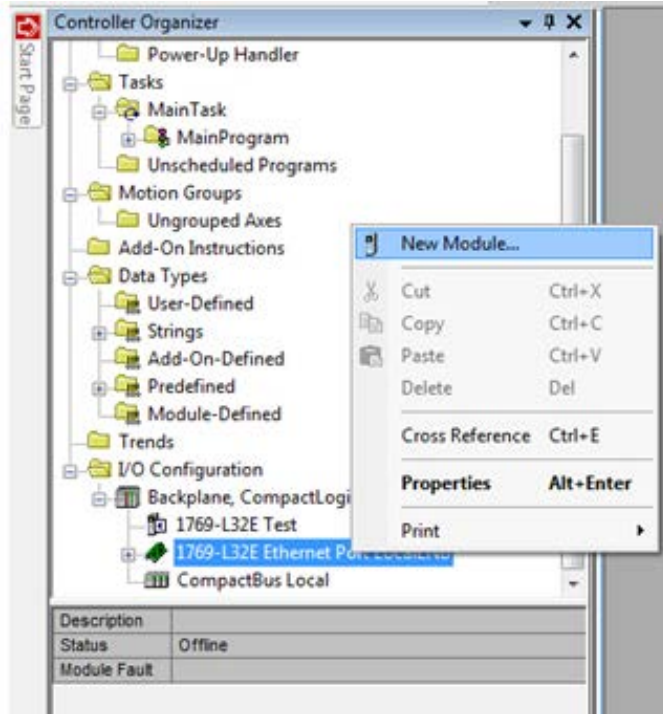

- b. Click **Communications**, then **Generic Ethernet Module**.

Figure 343. Select Module

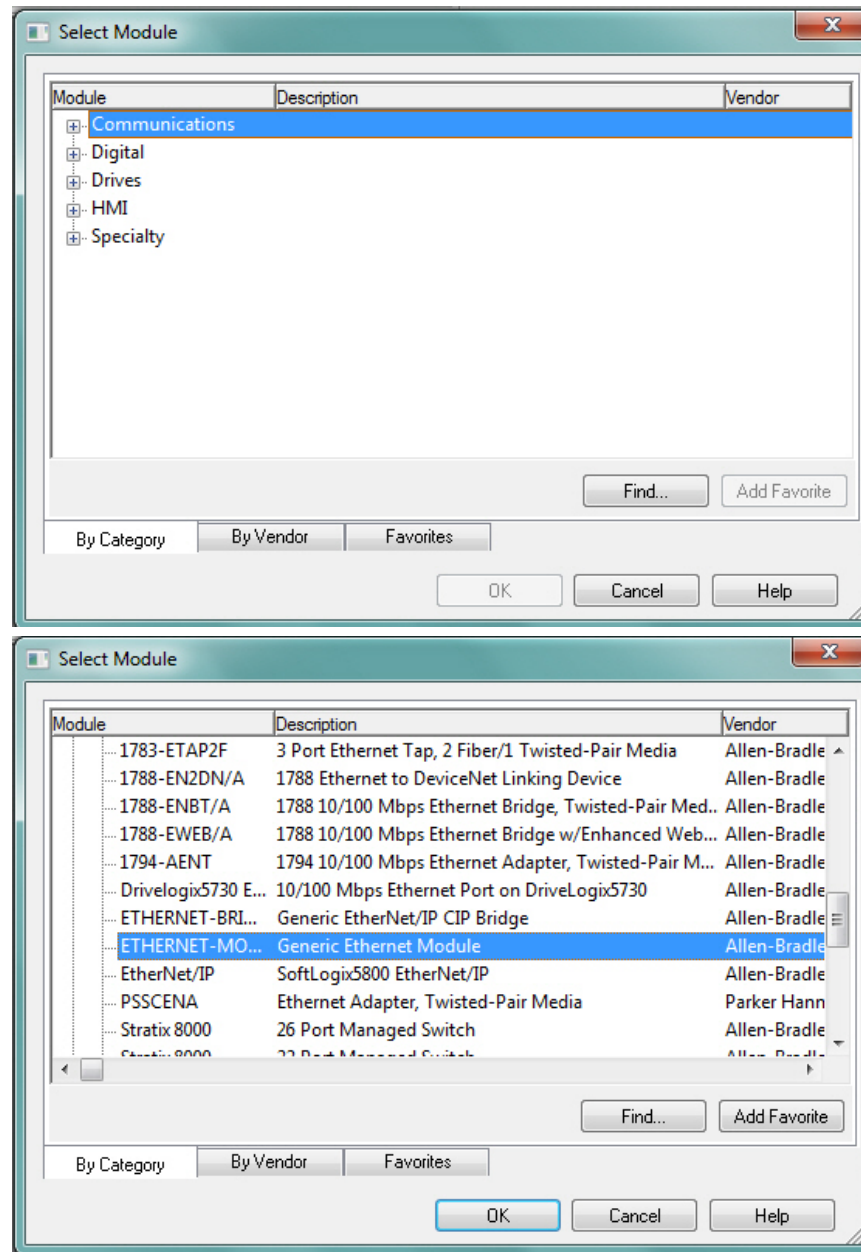

2. Configure the Module Properties.



Note: The data type in the Comm Format must be changed to an INT.

See [Inputs to the Sensor \(Outputs from the PLC\)](#) on p. 181 and [Outputs from the Sensor \(Inputs to the PLC\)](#) on p. 182 for more information on each specific assembly instance.

Figure 344. Example: PLC Input Assembly Instance 0x64 (100), PLC Output Assembly Instance 0x70 (112)

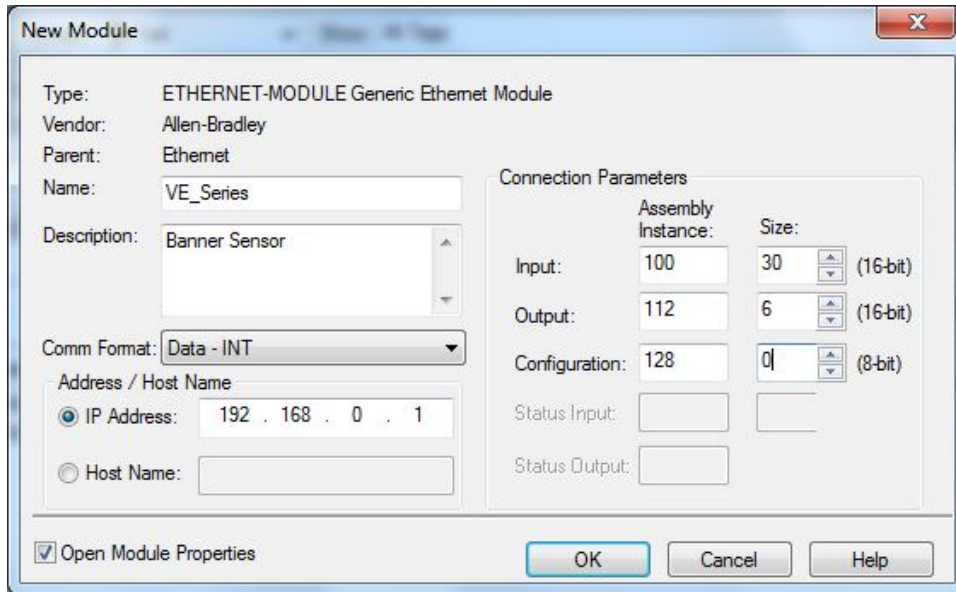

Figure 345. Example: PLC Input Assembly Instance 0x65 (101), PLC Output Assembly Instance 0x71 (113)

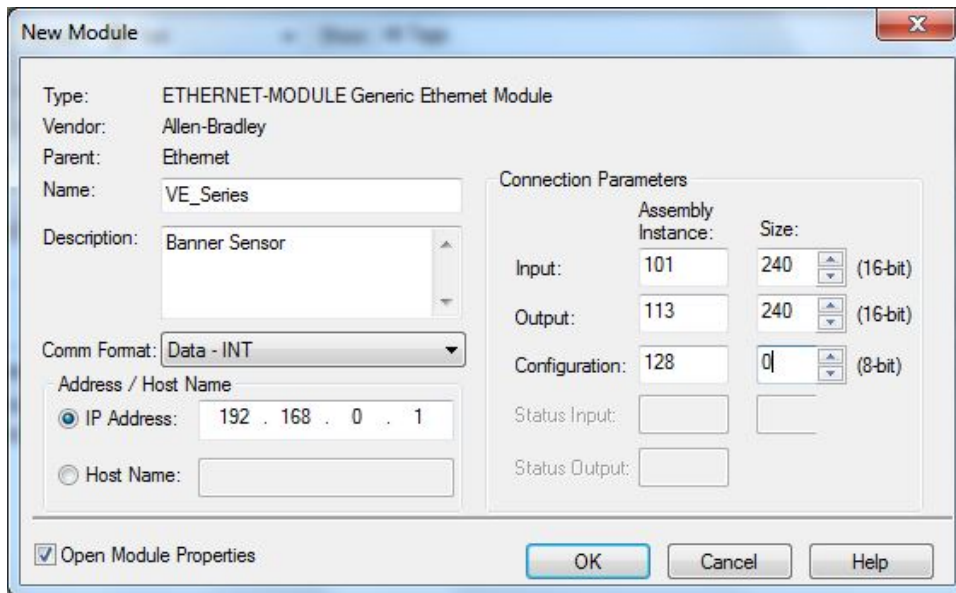

Figure 346. PLC Input Assembly (102), PLC Output Assembly (114)

Figure 347. Select or clear the Unicast Connection checkbox as desired



Note: The minimum allowed RPI is 50 ms.

3. If the module configuration was successful, the following information displays:

Figure 348. Successful Configuration

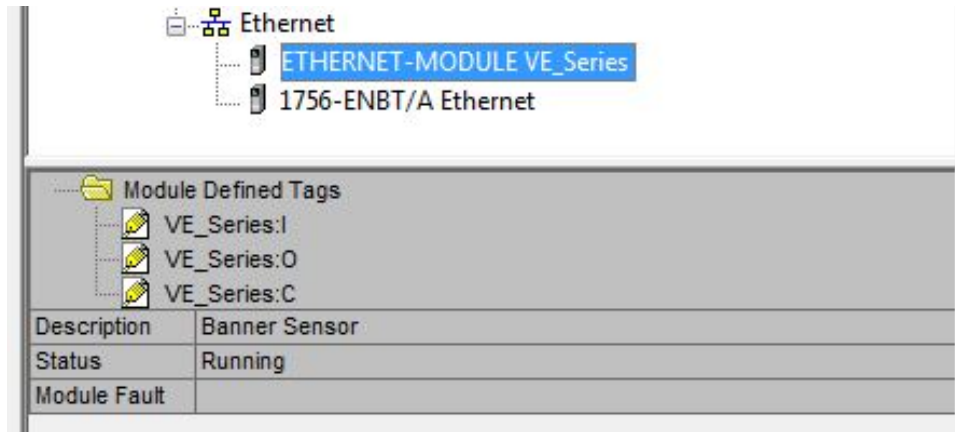

If the module configuration was not successful, the RSLogix 5000 software will indicate errors similar to the following figures:

Figure 349. ERROR: Assembly Instance Number and/or Size Incorrect

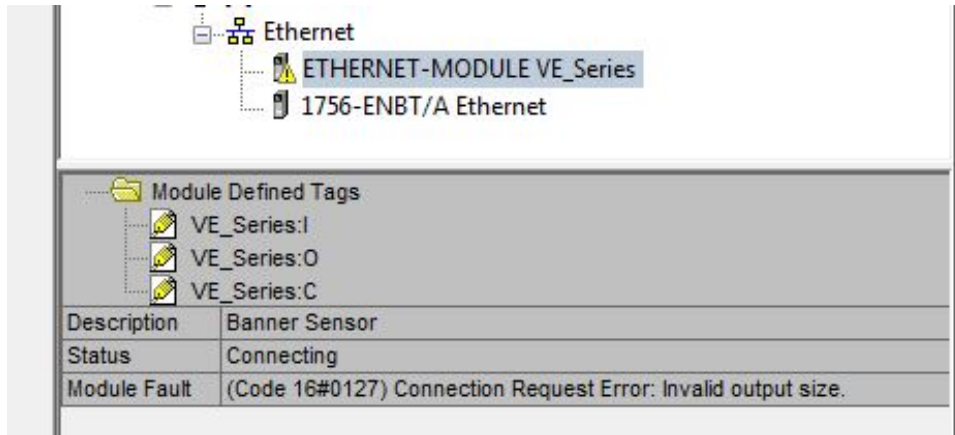
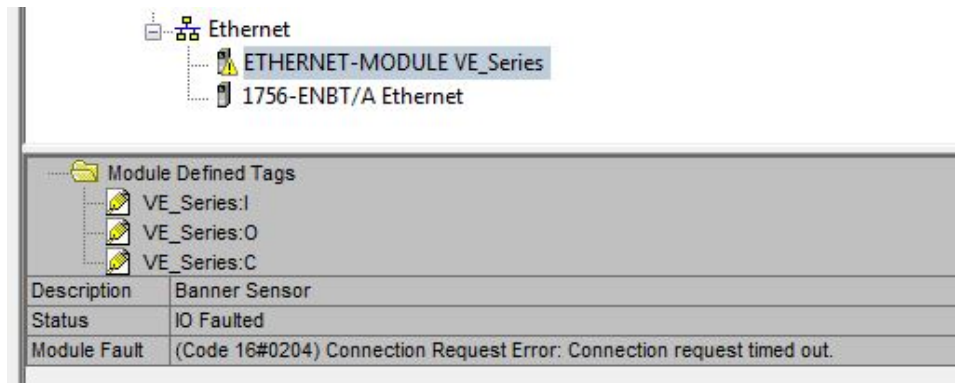
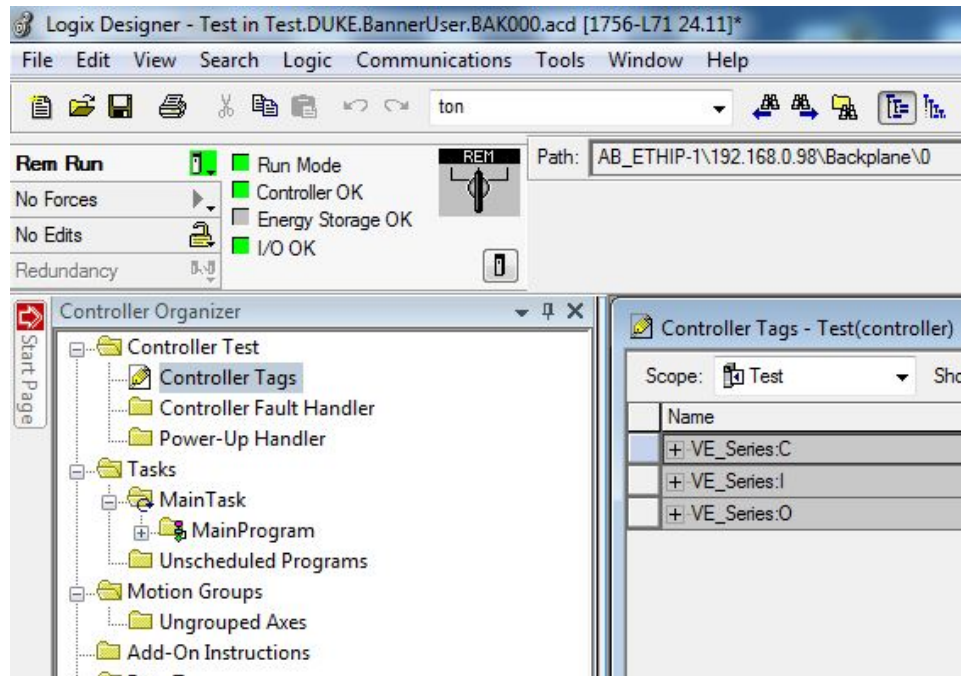

Figure 350. ERROR: VE Series camera Not Powered Up or Ethernet Cable Not Attached



4. Locate the memory map setup from the Banner module to the PLC memory map.

Figure 351. Memory Map



C = Configuration (not used)
 I = Inputs to PLC (outputs from the device)
 O = Outputs from PLC (inputs to the device)

Figure 352. Memory Map Expanded

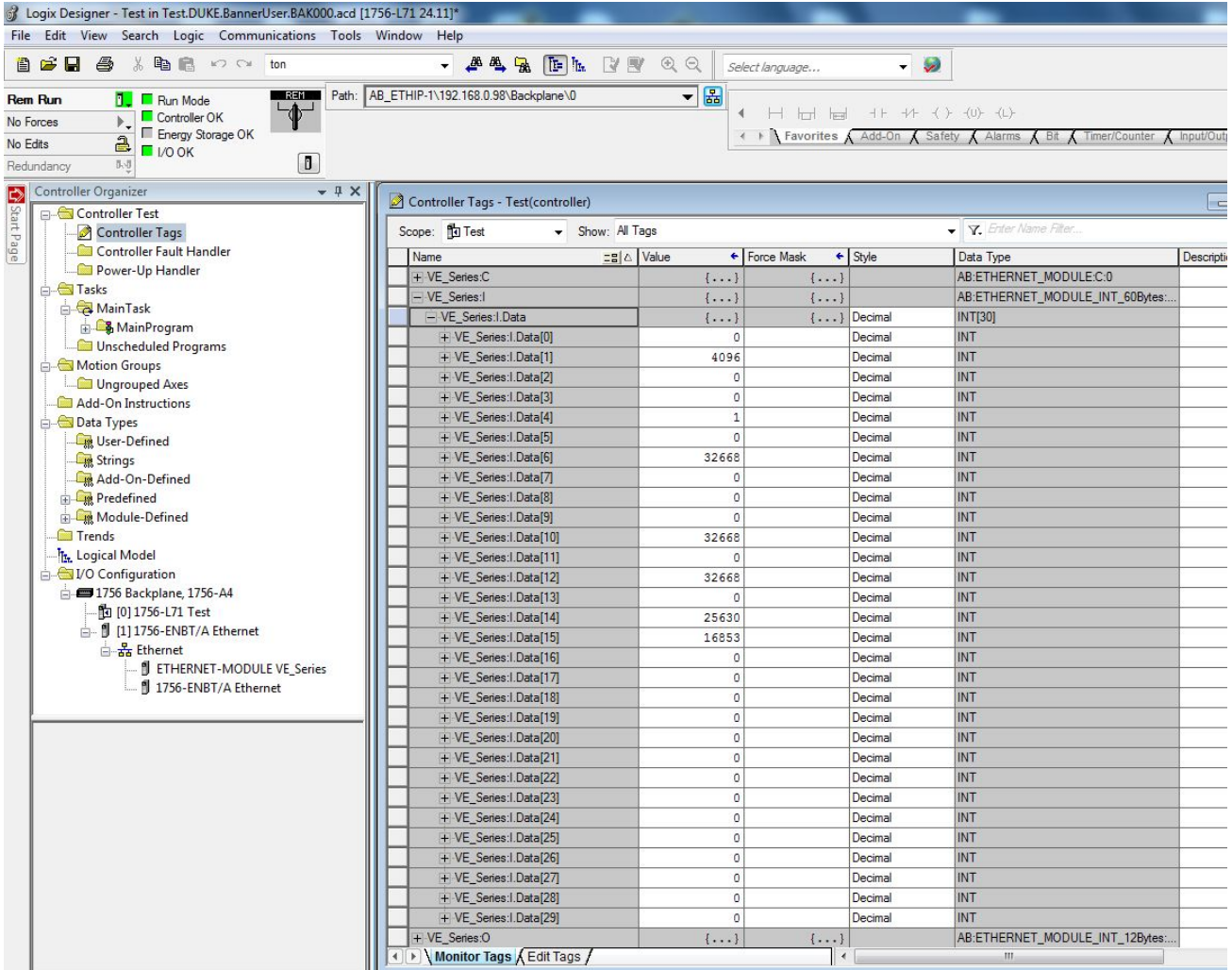

The VE Series camera memory map expanded. I = Inputs to PLC (outputs from the device).

14.4 Modbus/TCP

The Modbus/TCP protocol provides device information using register and coil banks defined by the slave device. This section defines the register and coil banks. By specification, Modbus/TCP uses TCP port 502.

The Modbus/TCP remote unit identifier is used with Modbus/TCP devices that are composites of several Modbus devices. For example, on Modbus/TCP to Modbus RTU gateways. In this case, the unit identifier tells the Slave Address of the device behind the gateway. Most Modbus/TCP Clients use a Unit ID of 1 or higher. If a Client with a Unit ID of 0 is used, in Vision Manager go to **System Settings > Communications > Industrial Protocols** and select the **Support Modbus Unit ID 0** checkbox to allow this connection.

The following registers are used to send values back and forth from the vision sensor to the PLC. VE Series camera read-only output data can be read as Input Registers (30000) using Modbus function code 04 (Read Input Registers). Because some devices like the Modicon family of PLCs cannot access data using the 30000 range of registers, the same values can also be seen as Holding Registers (40000) using Modbus function code 03 (Read Holding Registers).

The Input Bits can be set as Coils using Modbus function code 05 (Force Single Coil). The state of the Input ACK Bits and Status Bits can be read as Inputs (10000) using Modbus function code 02 (Read Input Status).

Modbus Function Codes Supported

- 01: Read Coil Status
- 02: Read Input Status
- 03: Read Holding Registers
- 04: Read Input Registers
- 05: Force Single Coil

06: Preset Single Register
 07: Read Exception Status
 16: Preset Multiple Registers

Table 11: Input Bits (Coils 00001-00016)

05: Force Single Coil		
Register	Bit Position	WORD Name
00001	0	Product Change
00002	1	Teach Latch
00003	2	Trigger
00004	3	<i>reserved</i>
00005	4	<i>reserved</i>
00006	5	<i>reserved</i>
00007	6	Barcode Data Compare Input String
00008	7	FTP Input String
00009	8	<i>reserved</i>
00010	9	<i>reserved</i>
00011	10	<i>reserved</i>
00012	11	<i>reserved</i>
00013	12	<i>reserved</i>
00014	13	<i>reserved</i>
00015	14	<i>reserved</i>
00016	15	<i>reserved</i>

Table 12: Input ACK Bits (Inputs 10001-10016)

02: Read Input Status		
Register	Bit Position	WORD Name
10001	0	Product Change ACK
10002	1	Teach Latch ACK
10003	2	Trigger ACK
10004	3	<i>reserved</i>
10005	4	<i>reserved</i>
10006	5	<i>reserved</i>
10007	6	Barcode Data Compare Input String ACK
10008	7	FTP Input String ACK
10009	8	<i>reserved</i>
10010	9	<i>reserved</i>
10011	10	<i>reserved</i>
10012	11	<i>reserved</i>
10013	12	<i>reserved</i>
10014	13	<i>reserved</i>
10015	14	<i>reserved</i>
10016	15	<i>reserved</i>

Table 13: Status Bits (Inputs 10017-10032)

02: Read Input Status		
Register	Bit Position	WORD Name
10017	0	Ready
10018	1	Pass/Fail
10019	2	<i>reserved</i>
10020	3	Ready Latch
10021	4	<i>reserved</i>
10022	5	Output 1
10023	6	Output 2
10024	7	Output 3
10025	8	Output 4
10026	9	Output 5
10027	10	<i>reserved</i>
10028	11	<i>reserved</i>
10029	12	Missed Trigger
10030	13	Teach Error
10031	14	System Error
10032	15	Execution Error

The following rules apply for the use of input bit commands:

- Only one VE Series camera input bit can be set at a time
- Corresponding ACK bits are set high only on completion of the command (if the VE input bit is still high)
- Corresponding ACK bits are cleared when the VE input bit is cleared
- When multiple VE input bits are set simultaneously, the Execution Error input bit is set and an Error Code value is reported in the Error Code register
- The Execution Error VE output bit is cleared when all ACK bits are cleared, or a new valid command is received

Figure 353. Trigger—Modbus/TCP, EtherNet/IP, PCCC

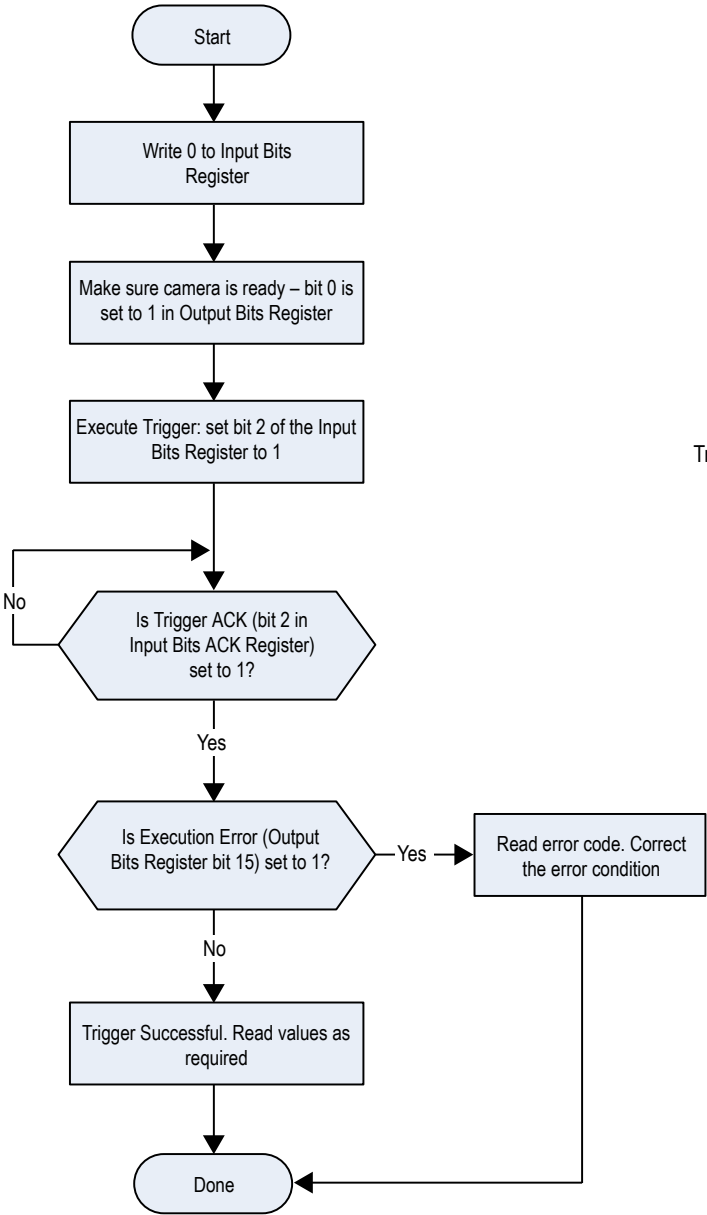

Figure 354. Trigger Timing Diagram

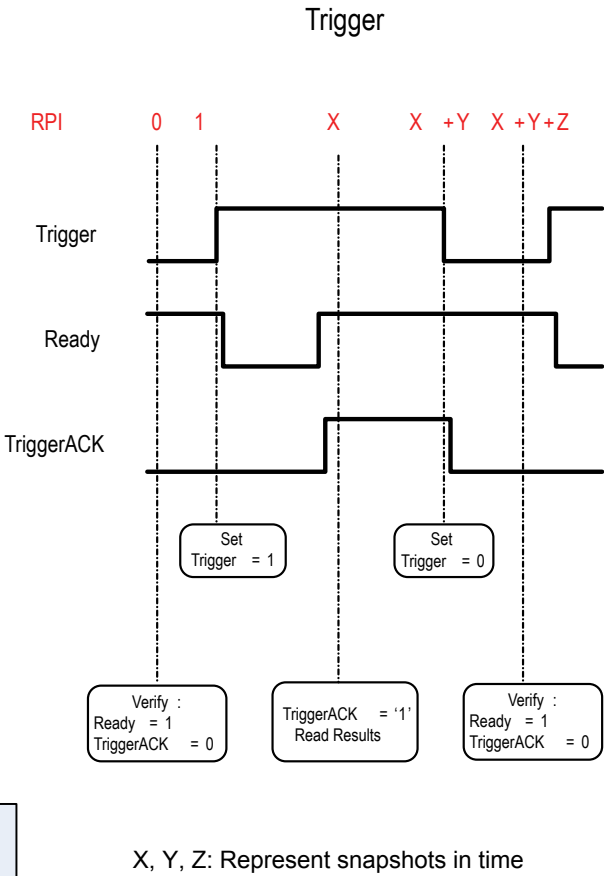

Figure 355. TEACH—Modbus/TCP, EtherNet/IP, PCCC

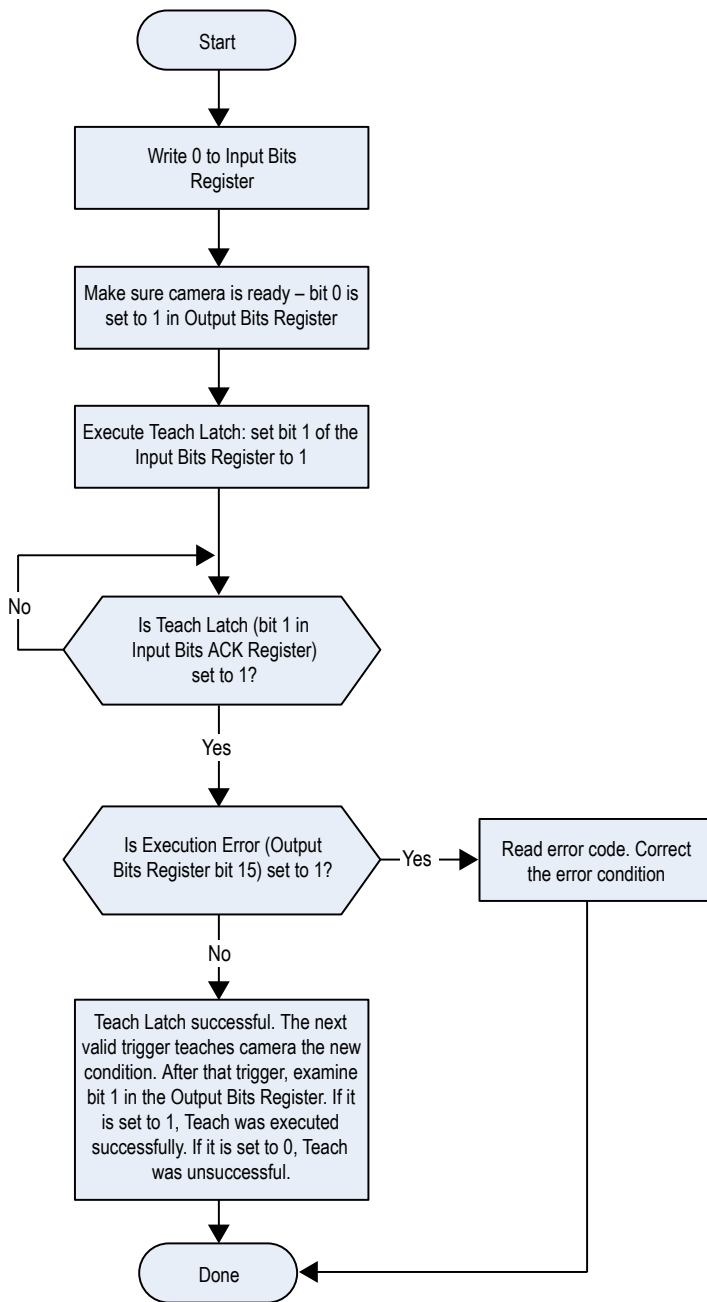

Figure 356. Teach Latch Timing Diagram

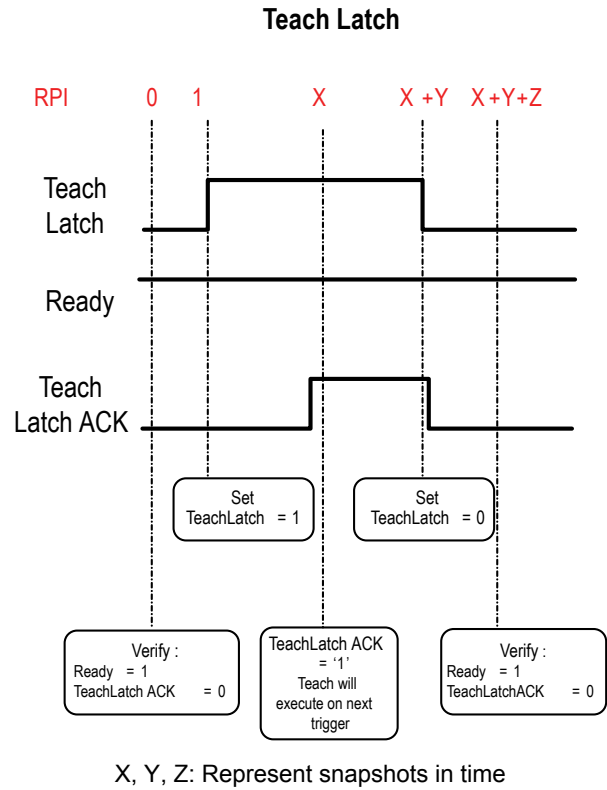

Figure 357. Product Change—Modbus/TCP, EtherNet/IP, PCCC

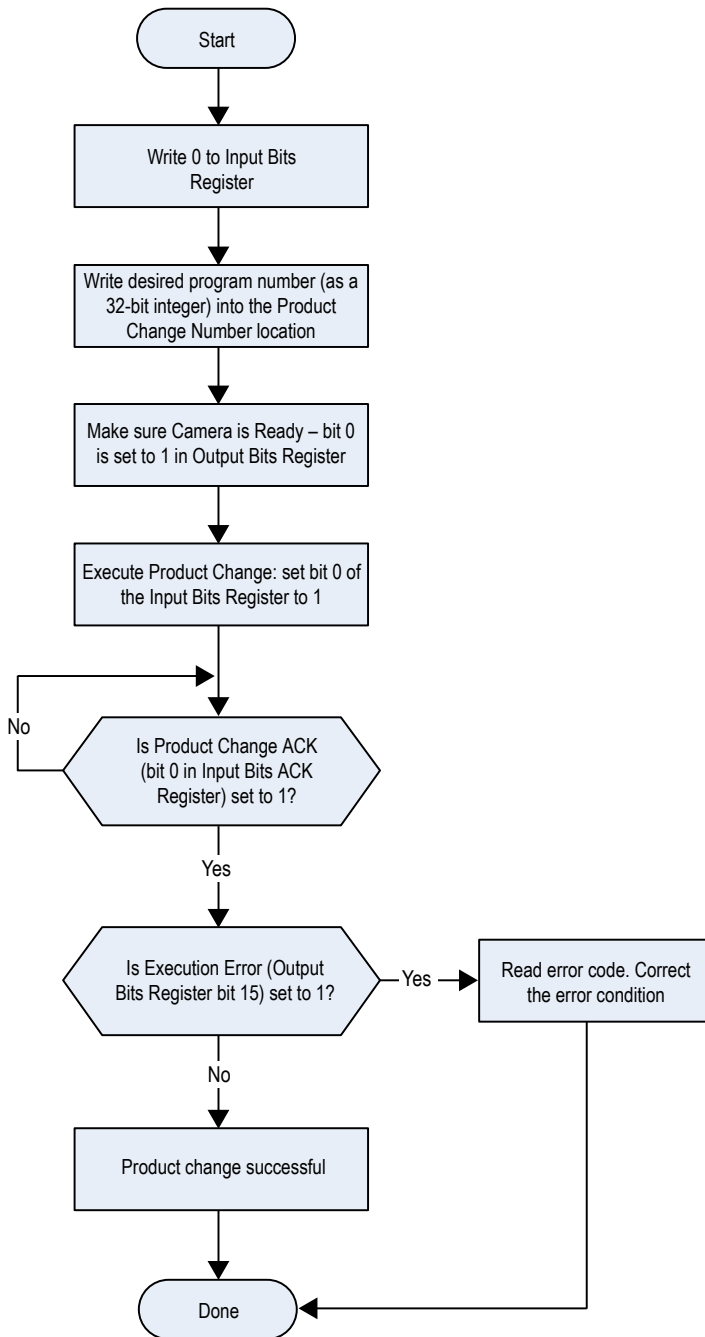
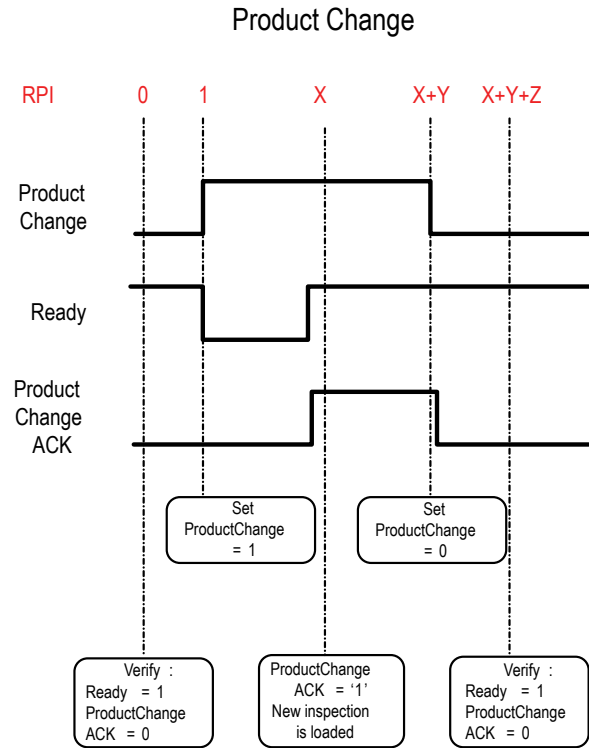

Figure 358. Product Change Timing Diagram



X, Y, Z: Represent snapshots in time

14.4.1 Sensor Input Values

Holding Registers (40000) are used by the PLC or HMI to write values to the VE Series camera. To write, use function codes 6 (Preset Single Register) or 16 (Preset Multiple Registers).

To use these Input Values for FTP Filename control, the **Industrial Protocol String** checkbox must be selected. See [Image Export: FTP](#) on p. 173.

To use these Input Values for setting the Barcode Data Compare String, the Data Compare checkbox on the Test tab must be selected. See [Barcode Tool: Test Parameters](#) on p. 145.

Table 14: VE Input Values (Modbus/TCP Holding Registers)

06: Preset Single Register or 16: Preset Multiple Registers		
REG #	WORD NAME	DATA TYPE
1	Input Bits (See Input and Output Bits on p. 204 and Coils 00001-16)	16-bit integer
2-3	Product Change Number	32-bit integer
4-5	<i>reserved</i>	16-bit integer
6	Input String Tool Index	16-bit integer
7-8	Input String Length	32-bit integer
9-34	Input String	String (52 characters)
35-500	<i>reserved</i>	16-bit integer

14.4.2 VE Series camera Output Values

The VE Series camera sends output data to the PLC or HMI via a bank of Input Registers (30000). Some devices, like the Modicon family of PLCs, cannot access data using the 30000 range of register addresses. For these devices, the VE output data is also made available as Holding Registers (40000). To access this data, use either function code 04 (Read Input Registers) or function code 03 (Read Holding Registers).

Table 15: VE Series camera Output Values (Modbus/TCP Input or Holding Registers)

04: Read Input Registers or 03: Read Holding Registers			
Input REG #	Holding REG #	WORD NAME	DATA TYPE
1	1001	Input ACK Bits (see Input and Output Bits on p. 204, and also Inputs 10001-16)	16-bit integer
2	1002	Status Bits (see Input and Output Bits on p. 204, and also Inputs 10017-32)	16-bit integer
3-4	1003-4	Error Code	32-bit integer
5-6	1005-6	Inspection Number	32-bit integer
7-8	1007-8	Iteration Count	32-bit integer
9-10	1009-10	Pass Count	32-bit integer
11-12	1011-12	Fail Count	32-bit integer
13-14	1013-14	Missed Triggers	32-bit integer
15-16	1015-16	Current Inspection Time	Float
17	1017	Sensor Pass/Fail Bits (see Sensor Pass/Fail Bits on p. 184)	16-bit integer
18-500	1018-500	User-defined (see Tool-Specific Results: Modbus/TCP on p. 205)	16-bit integer

14.4.3 Input and Output Bits

Writeable **Input Bits** are inputs to the VE Series camera (outputs from the PLC or HMI). They are used for basic control of the VE Series camera. They are accessible using function code 6 (Preset Single Register). The same control is also possible using Coils 00001-16, function code 05 (Force Single Coil).

Table 16: Input Bits: PLC Holding Register 1, also Coils 00001-16

Coil 16	Coil 15	Coil 14	Coil 13	Coil 12	Coil 11	Coil 10	Coil 9	Coil 8	Coil 7	Coil 6	Coil 5	Coil 4	Coil 3	Coil 2	Coil 1
Bit 15	Bit 14	Bit 13	Bit 12	Bit 11	Bit 10	Bit 9	Bit 8	Bit 7	Bit 6	Bit 5	Bit 4	Bit 3	Bit 2	Bit 1	Bit 0

reserved	reserved	reserved	reserved	reserved	reserved	reserved	reserved	FTP Input String	Barcode Data Compare Input String	reserved	reserved	reserved	Trigger	Teach Latch	Product Change
----------	----------	----------	----------	----------	----------	----------	----------	------------------	-----------------------------------	----------	----------	----------	---------	-------------	----------------

Read-only **Input ACK Bits** are outputs from the VE Series camera (inputs to the PLC or HMI). They are used to acknowledge each of the input bits sent from the PLC. For example, if the PLC changes the Trigger bit (from Input Bits, above) from a 0 to a 1, the VE changes the Trigger ACK bit from a 0 to a 1 in response. This information is available as Input Registers or Holding Registers. Use either function code 04 (Read Input Registers) or function code 03 (Read Holding Registers). The same data can also be read from Inputs (10000) using Modbus function code 02 (Read Input Status).

Table 17: Input ACK Bits: PLC Input Register 1 or Holding Register 1001, also Inputs 10001-16

Input 16	Input 15	Input 14	Input 13	Input 12	Input 11	Input 10	Input 9	Input 8	Input 7	Input 6	Input 5	Input 4	Input 3	Input 2	Input 1
Bit 15	Bit 14	Bit 13	Bit 12	Bit 11	Bit 10	Bit 9	Bit 8	Bit 7	Bit 6	Bit 5	Bit 4	Bit 3	Bit 2	Bit 1	Bit 0
reserved	reserved	reserved	reserved	reserved	reserved	reserved	reserved	FTP Input String ACK	Barcode Data Compare Input String ACK	reserved	reserved	reserved	Trigger ACK	Teach Latch ACK	Product Change ACK

Read-only **Status Bits** are outputs from the VE Series camera (inputs to the PLC or HMI). They are used to report the basic status of the VE Series camera and the last inspection run. This information is available as Input Registers or Holding Registers. Use either function code 04 (Read Input Registers) or function code 03 (Read Holding Registers). The same data can also be read from Inputs (10000) using Modbus function code 02 (Read Input Status).

Table 18: Status Bits: PLC Input Register 2 or Holding Register 1002, also Inputs 10017-32

Input 32	Input 31	Input 30	Input 29	Input 28	Input 27	Input 26	Input 25	Input 24	Input 23	Input 22	Input 21	Input 20	Input 19	Input 18	Input 17
Bit 15	Bit 14	Bit 13	Bit 12	Bit 11	Bit 10	Bit 9	Bit 8	Bit 7	Bit 6	Bit 5	Bit 4	Bit 3	Bit 2	Bit 1	Bit 0
Execution Error	System Error	Teach Error	Missed Trigger	reserved	reserved	Output 5	Output 4	Output 3	Output 2	Output 1	reserved	Ready Latch	reserved	Pass/Fail	Ready

14.4.4 Sensor Pass/Fail Bits

For the sensor pass/fail bits, pass = 1 and fail = 0.

Table 19: Sensor Pass/Fail Bits

Bit Position															
15	14	13	12	11	10	9	8	7	6	5	4	3	2	1	0
Vision	Vision	Vision	Vision	Vision	Vision	Vision	Vision	Vision	Vision	Vision	Vision	Vision	Vision	Vision	Camera
Tool 15	Tool 14	Tool 13	Tool 12	Tool 11	Tool 10	Tool 9	Tool 8	Tool 7	Tool 6	Tool 5	Tool 4	Tool 3	Tool 2	Tool 1	Tool
Pass/Fail	Pass/Fail	Pass/Fail	Pass/Fail	Pass/Fail	Pass/Fail	Pass/Fail	Pass/Fail	Pass/Fail	Pass/Fail	Pass/Fail	Pass/Fail	Pass/Fail	Pass/Fail	Pass/Fail	Pass/Fail

14.4.5 Tool-Specific Results: Modbus/TCP

Configure the VE to output user-defined, tool-specific results to the PLC using a custom map.

The sensor output values (Modbus/TCP Input or Holding Registers) include both system-defined and user-defined results in the map. To set the user-defined, tool-specific results in the custom map, navigate: **System Settings > Communications > Industrial Protocols**.

Figure 359. Industrial Protocols Tab—Modbus/TCP

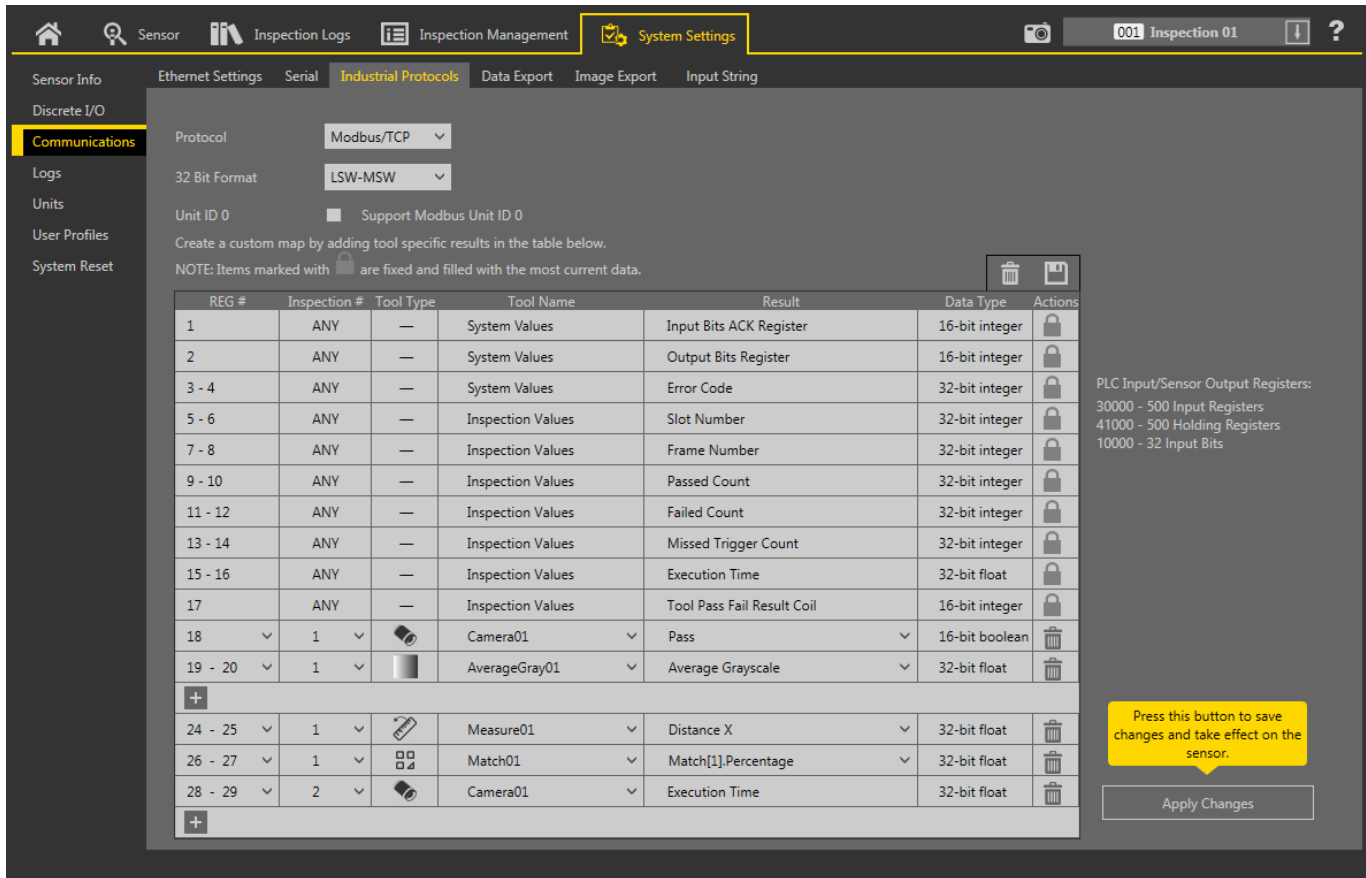

The results are configurable only for the current inspection. However, all user-defined results in the custom map are shown on the Industrial Protocols tab whether or not they are included in the current inspection. To make changes to a different inspection, switch to the desired inspection and then make changes to the custom map. Updating the map does not disconnect the sensor from the PLC.

To configure the map:

1. Click to add a new line to the map.
2. Set the Word/Register/Byte, Tool Name, and Result. See the following descriptions for more information.
3. Click **Apply Changes** to send the current map to the camera.



Important: Click **Apply Changes** or all user-defined data is lost when you click away from the Industrial Protocols tab.

4. Click to print and save a PDF of the current map. The PDF includes all data, whether system-defined or user-defined.
5. To return the map to the default settings, click . All user-defined output data is deleted.

Column descriptions:

REG #

The data location.

Inspection #

Shows whether this tool result applies to the current inspection only (*inspection number*) or to any inspection (ANY) that includes the selected tool.

An Inspection # of ANY means that if an inspection includes a tool with the exact name (for example, *AverageGray01*), the results are output. If an inspection does not have a tool with the exact name (for example *AverageGrayAssemblyLine01*), no results are output for that tool and that inspection.

Tool Type

Displays a graphic that represents the type of tool selected in the Tool Name column.

Tool Name

Select the desired Tool Name from the list. The list includes the tools available in the current inspection only. Select a different inspection from the inspection list, if necessary.



Result

The information to output.

Data Type

The type of information to output.

Actions

Click  to delete a result. You cannot delete system-defined results that contain the  symbol.

14.5 PLC5, SLC500, and MicroLogix (PCCC)

Allen-Bradley's PLC5, SLC 500, and MicroLogix family of devices uses PCCC communications protocol.

PCCC is also known as EtherNet/IP transport class 3 and uses explicit Read and Write message commands, or EIP messaging, placed into the ladder logic program, to interface with the VE Series camera.

These PLCs do not support cyclic EtherNet/IP IO data transfer (referred to as EtherNet/IP in this manual). The programming software used by these PLCs is RSLogix 5 (PLC5) or RSLogix 500 (SLC500 and MicroLogix series).

The VE Series camera supports these PLCs using input and output register arrays.

The Output bits, ACK bits and Input bits bit definitions are the same as defined in the I/O Assembly Objects section. The terms "Input" and "Output" are from the point of view of the PLC.

The following rules apply for the use of input bit commands:

- Only one VE Series camera input bit can be set at a time
- Corresponding ACK bits are set high only on completion of the command (if the VE input bit is still high)
- Corresponding ACK bits are cleared when the VE input bit is cleared
- When multiple VE input bits are set simultaneously, the Execution Error input bit is set and an Error Code value is reported in the Error Code register
- The Execution Error VE output bit is cleared when all ACK bits are cleared, or a new valid command is received

Figure 360. Trigger—Modbus/TCP, EtherNet/IP, PCCC

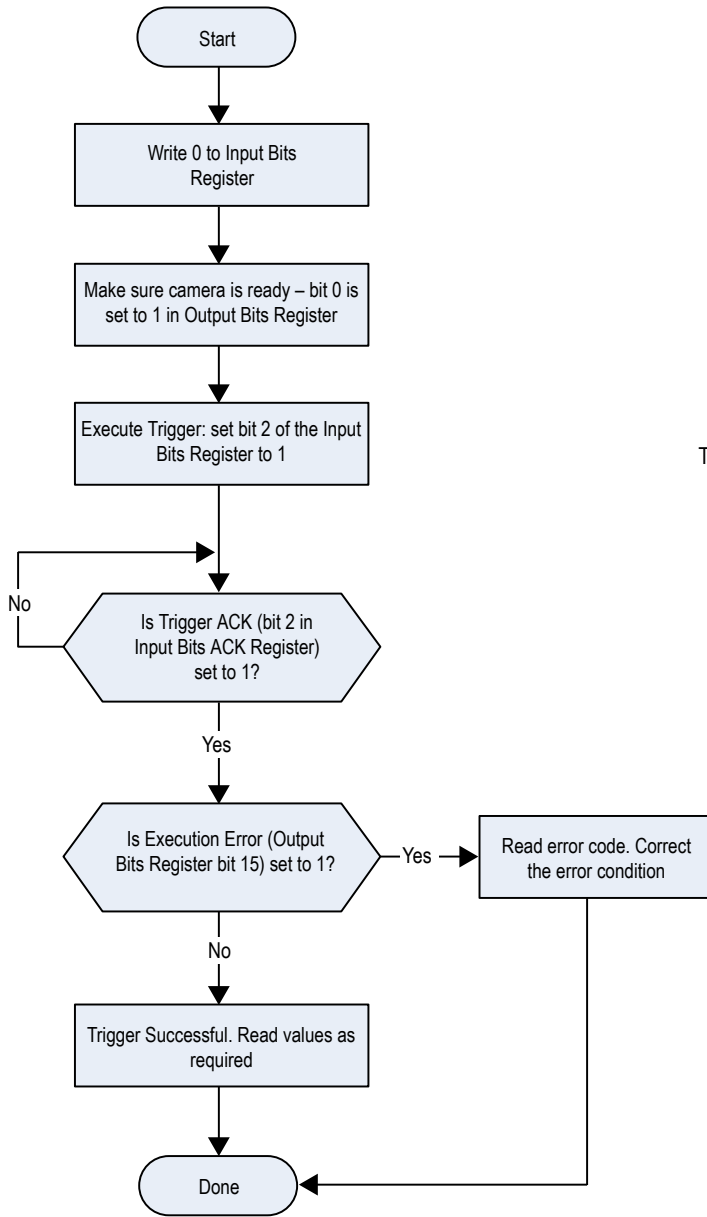

Figure 361. Trigger Timing Diagram

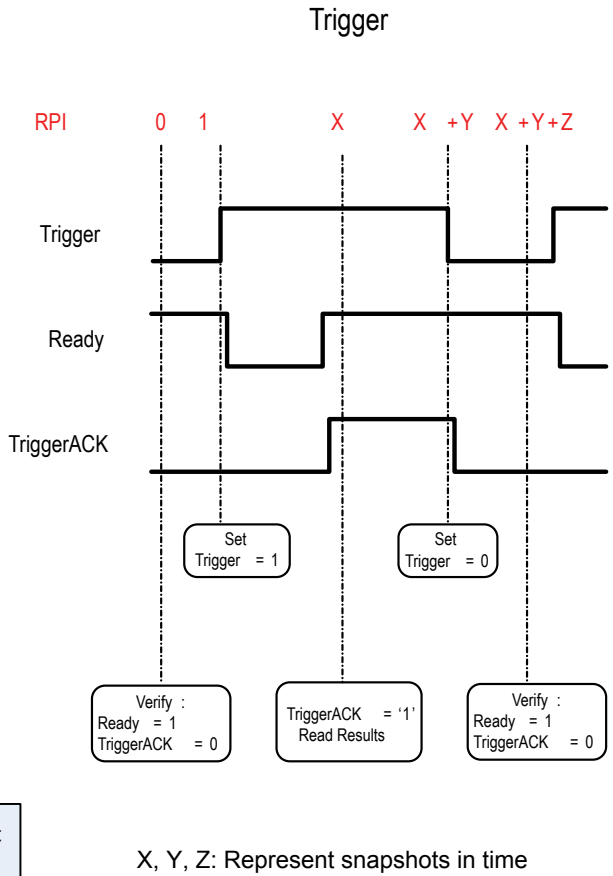

Figure 362. TEACH—Modbus/TCP, EtherNet/IP, PCCC

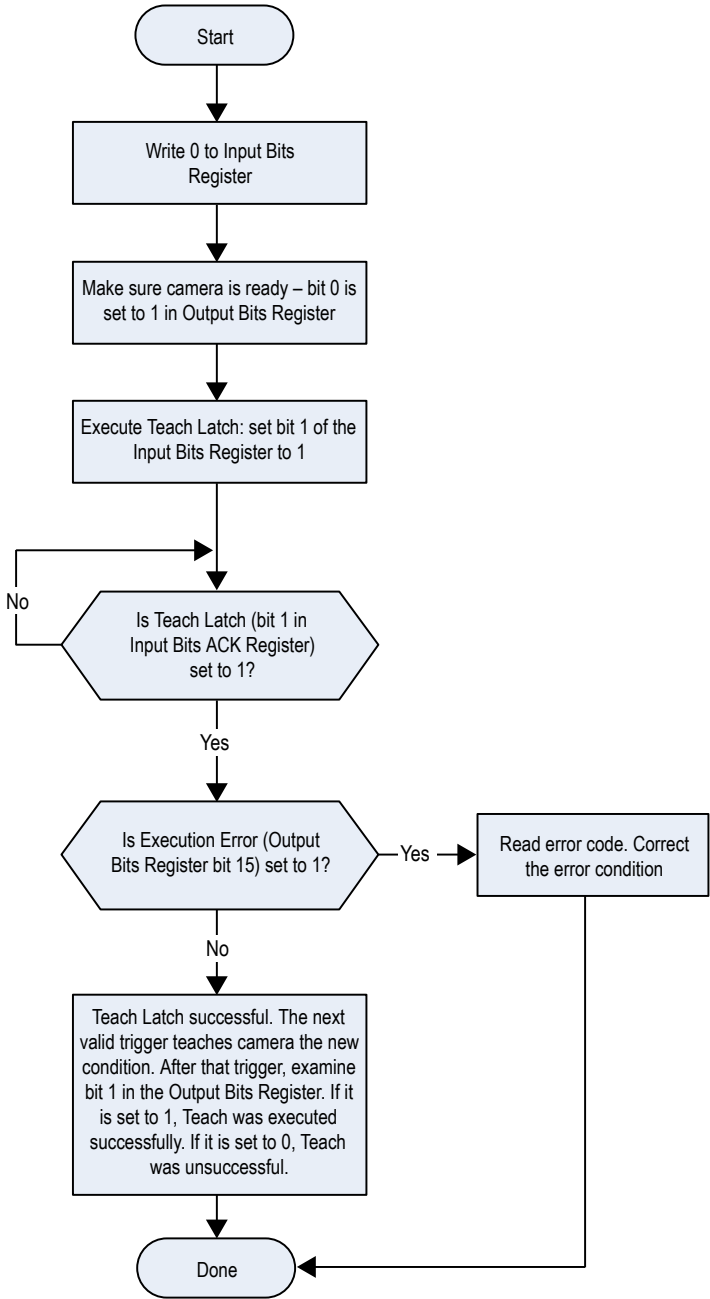

Figure 363. Teach Latch Timing Diagram

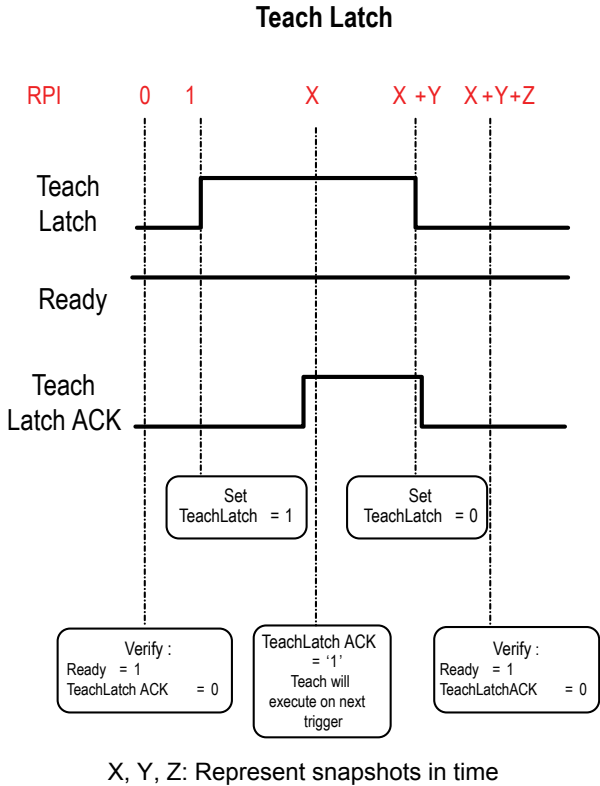

Figure 364. Product Change—Modbus/TCP, EtherNet/IP, PCCC

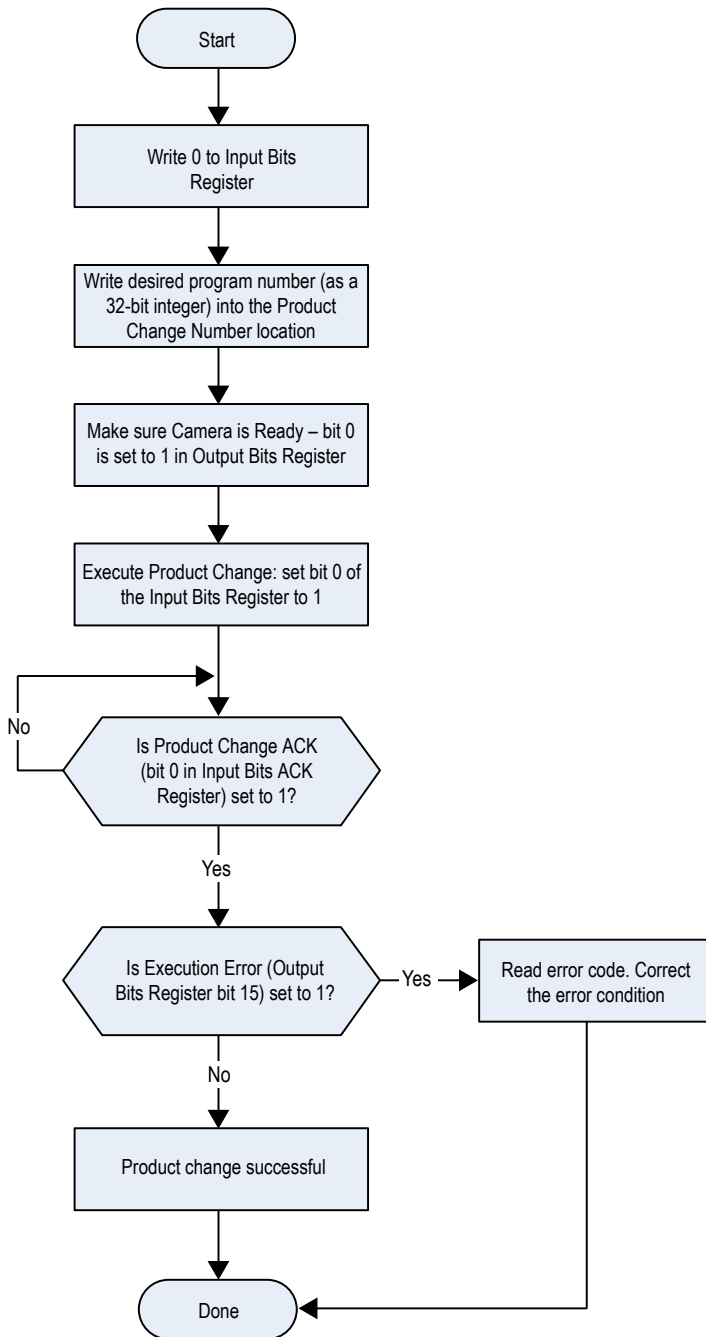
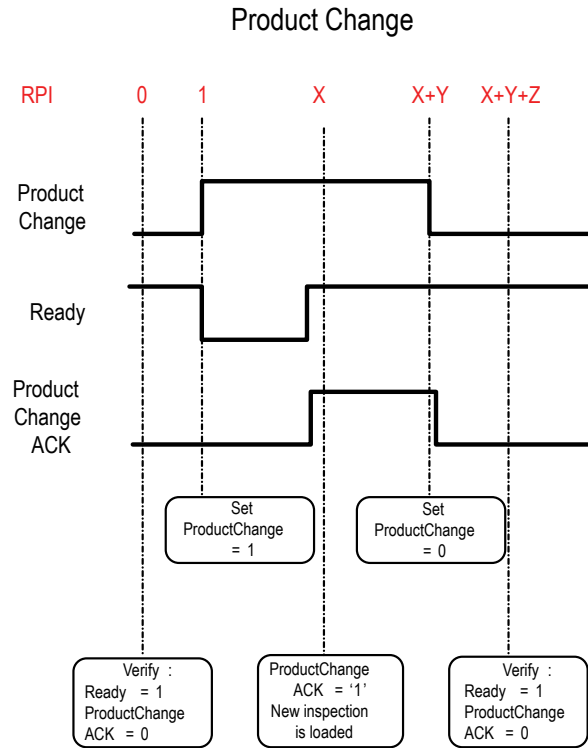

Figure 365. Product Change Timing Diagram



X, Y, Z: Represent snapshots in time

14.5.1 Configuration

The following images represent a typical configuration.

PLC Read Message Command

Figure 366. General tab: Example message command reading from N7 table on the VE and sending the data to the N7 table on the PLC

MSG - N20:0 : (51 Elements)

General | MultiHop

This Controller
 Communication Command:
 Data Table Address:
 Size in Elements:
 Channel:

Target Device
 Message Timeout:
 Data Table Address:
 Local / Remote: MultiHop:

Control Bits
 Ignore if timed out (TO):
 To be retried (NR):
 Awaiting Execution (EW):
 Continuous Run (CO):
 Error (ER):
 Message done (DN):
 Message Transmitting (ST):
 Message Enabled (EN):
 Waiting for Queue Space:

Error
 Error Code(Hex):

Error Description
 No errors

This Controller

Communications Command = PLC5 Read

Data Table Address = Integer table "Nx"

Target Device

Data Table Address = N7:x

Figure 367. MultiHop tab: IP Address of the VE is entered here

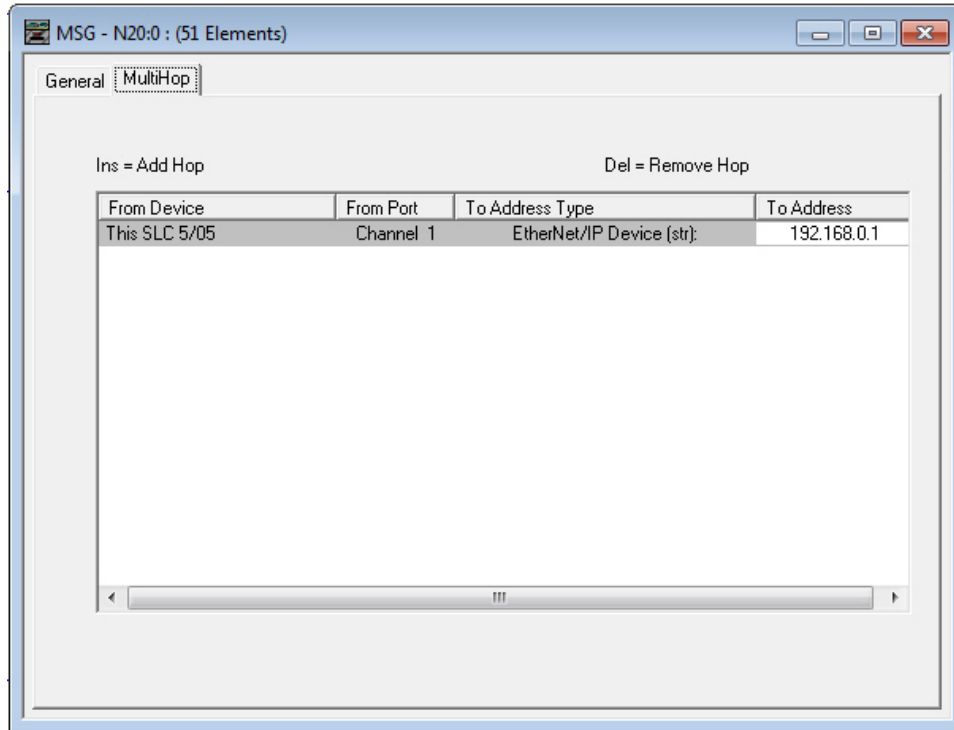

To Address = IP address of the VE

PLC Write Message Command

Figure 368. General tab: Example message command writing to N14 table on the VE from the N14 table of the PLC

MSG - N21:0 : (51 Elements)

General | MultiHop

This Controller
 Communication Command:
 Data Table Address:
 Size in Elements:
 Channel:

Target Device
 Message Timeout:
 Data Table Address:
 Local / Remote: MultiHop:

Control Bits
 Ignore if timed out (TO):
 To be retried (NR):
 Awaiting Execution (EW):
 Continuous Run (CO):
 Error (ER):
 Message done (DN):
 Message Transmitting (ST):
 Message Enabled (EN):
 Waiting for Queue Space:

Error
 Error Code(Hex):

Error Description
 No errors

This Controller

Communications Command = PLC5 Write

Data Table Address = Integer table "Nx"

Target Device

Data Table Address = N14:x

Figure 369. MultiHop tab: IP address of the VE is entered here

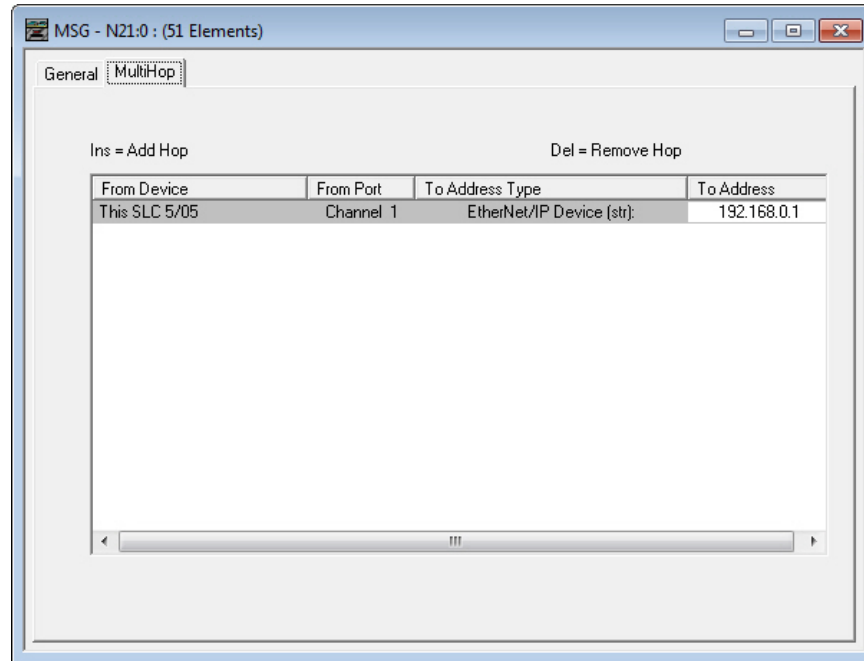

To Address = IP address of the VE

14.5.2 Inputs to the Sensor (Outputs from the PLC)

The registers below are used by the PLC to push values to the VE Series camera. MSG (message) commands are used to write (N14) to the sensor.

Table 20: PCCC PLC Output Registers (Sensor Inputs, N14 Table on the Sensor)

WORD #	WORD NAME	DATA TYPE
0	Input Bits Register (see Input and Output Bits on p. 215)	16-bit integer
1-2	Product Change Number	32-bit integer
3-4	<i>reserved</i>	16-bit Integer
5	Input String Tool Index	16-bit Integer
6-7	Input String Length	32-bit Integer
8-33	Input String	String (52 characters)
34-500	<i>reserved</i>	32-bit integer

14.5.3 Outputs from the Sensor (Inputs to the PLC)

The registers below are used to send output values from the VE Series camera to the PLC. MSG (message) commands are used to read (N7) from the sensor.

Table 21: PCCC PLC Input Registers (Sensor Outputs, N7 Table on the Sensor)

WORD #	WORD NAME	DATA TYPE
0	Input Bits ACK Register (see Input and Output Bits on p. 215)	16-bit integer
1	Output Bits Register (see Input and Output Bits on p. 215)	16-bit integer
2-3	Error Code	32-bit integer
4-5	Inspection Number	32-bit integer

WORD #	WORD NAME	DATA TYPE
6-7	Iteration Count	32-bit integer
8-9	Pass Count	32-bit integer
10-11	Fail Count	32-bit integer
12-13	Missed Triggers	32-bit integer
14-15	Current Inspection Time	Float
16	Sensor Pass/Fail Bits (see Sensor Pass/Fail Bits on p. 184)	16-bit integer
17-500	User-defined (see Tool-Specific Results: PCCC on p. 216)	16-bit integer

14.5.4 Input and Output Bits

The Input Bits are used to command execution of basic functions. The Output Bits are used to push single bit outputs from the VE Series camera to the PLC. The 32 bits of VE Series camera output can also be accessed using the bits of the first two Output Registers (Input Bits ACK Register(word 0) and Output Bits Register (word1)).

Table 22: Input Bits Register (Command Bits)

Bit Position															
15	14	13	12	11	10	9	8	7	6	5	4	3	2	1	0
reserved	reserved	reserved	reserved	reserved	reserved	reserved	reserved	FTP Input String	Barcode Data Compare Input String	reserved	reserved	reserved	Trigger	Teach Latch	Product Change

Table 23: Input Bits ACK Register (ACK Bits)

Bit Position															
15	14	13	12	11	10	9	8	7	6	5	4	3	2	1	0
reserved	reserved	reserved	reserved	reserved	reserved	reserved	reserved	FTP Input String ACK	Barcode Data Compare Input String ACK	reserved	reserved	reserved	Trigger ACK	Teach Latch ACK	Product Change ACK

Table 24: Output Bits Register (Sensor Status Bits)

Bit Position															
15	14	13	12	11	10	9	8	7	6	5	4	3	2	1	0
Execution Error	System Error	Teach Error	Missed Trigger	reserved	reserved	Output 5	Output 4	Output 3	Output 2	Output 1	reserved	Ready Latch	reserved	Pass/Fail	Ready

14.5.5 Sensor Pass/Fail Bits

For the sensor pass/fail bits, pass = 1 and fail = 0.

Table 25: Sensor Pass/Fail Bits

Bit Position															
15	14	13	12	11	10	9	8	7	6	5	4	3	2	1	0
Vision Tool 15 Pass/Fail	Vision Tool 14 Pass/Fail	Vision Tool 13 Pass/Fail	Vision Tool 12 Pass/Fail	Vision Tool 11 Pass/Fail	Vision Tool 10 Pass/Fail	Vision Tool 9 Pass/Fail	Vision Tool 8 Pass/Fail	Vision Tool 7 Pass/Fail	Vision Tool 6 Pass/Fail	Vision Tool 5 Pass/Fail	Vision Tool 4 Pass/Fail	Vision Tool 3 Pass/Fail	Vision Tool 2 Pass/Fail	Vision Tool 1 Pass/Fail	Camera Tool Pass/Fail

14.5.6 Tool-Specific Results: PCCC

Configure the VE to output user-defined, tool-specific results to the PLC using a custom map.

The output submodule includes both system-defined and user-defined results in the map. To set the user-defined, tool-specific results in the custom map, navigate: **System Settings > Communications > Industrial Protocols**.

Figure 370. Industrial Protocols Tab—PCCC

The screenshot shows the 'Industrial Protocols' configuration page. At the top, 'Protocol' is set to 'PCCC' and '32 Bit Format' is set to 'LSW-MSW'. Below this, a table lists various tool-specific results. The table has columns for WORD #, Inspection #, Tool Type, Tool Name, Result, Data Type, and Actions. A yellow callout box points to the 'Apply Changes' button with the text: 'Press this button for changes to take effect on the camera.'

WORD #	Inspection #	Tool Type	Tool Name	Result	Data Type	Actions
0	ANY	—	Global Values	Input Bits ACK Register	16-bit integer	🔒
1	ANY	—	Global Values	Output Bits Register	16-bit integer	🔒
2 - 3	ANY	—	Global Values	Error Code	32-bit integer	🔒
4 - 5	ANY	—	Inspection Values	Slot Number	32-bit integer	🔒
6 - 7	ANY	—	Inspection Values	Frame Number	32-bit integer	🔒
8 - 9	ANY	—	Inspection Values	Passed	32-bit integer	🔒
10 - 11	ANY	—	Inspection Values	Failed	32-bit integer	🔒
12 - 13	ANY	—	Inspection Values	Missed Triggers	32-bit integer	🔒
14 - 15	ANY	—	Inspection Values	Execution Time	32-bit float	🔒
16	ANY	—	Inspection Values	Tool Pass Fail Result Coil	16-bit integer	🔒
17	1	📷	Camera01	Pass	16-bit boolean	🗑️
18 - 19	1	🖼️	AverageGray01	Average Grayscale	32-bit float	🗑️
+						
23 - 24	1	📏	Measure01	Distance X	32-bit float	🗑️
25 - 26	ANY	📐	Match01	Match[1].Percentage	32-bit float	🗑️
27 - 28	2	📷	Camera01	Execution Time	32-bit float	🗑️
+						

PLC Input File: N7 - 500 Words

The results are configurable only for the current inspection. However, all user-defined results in the custom map are shown on the Industrial Protocols tab whether or not they are included in the current inspection. To make changes to a different inspection, switch to the desired inspection and then make changes to the custom map. Updating the map does not disconnect the sensor from the PLC.

To configure the map:

1. Click to add a new line to the map.
2. Set the Word/Register/Byte, Tool Name, and Result. See the following descriptions for more information.
3. Click **Apply Changes** to send the current map to the camera.



Important: Click **Apply Changes** or all user-defined data is lost when you click away from the **Industrial Protocols** tab.

4. Click to print and save a PDF of the current map. The PDF includes all data, whether system-defined or user-defined.
5. To return the map to the default settings, click . All user-defined output data is deleted.

Column descriptions:

WORD #

The data location.

Inspection #

Shows whether this tool result applies to the current inspection only (*inspection number*) or to any inspection (ANY) that includes the selected tool.

An Inspection # of ANY means that if an inspection includes a tool with the exact name (for example, *AverageGray01*), the results are output. If an inspection does not have a tool with the exact name (for example *AverageGrayAssemblyLine01*), no results are output for that tool and that inspection.

Tool Type

Displays a graphic that represents the type of tool selected in the Tool Name column.

Tool Name

Select the desired Tool Name from the list. The list includes the tools available in the current inspection only. Select a different inspection from the inspection list, if necessary.



Result

The information to output.

Data Type

The type of information to output.

Actions

Click  to delete a result. You cannot delete system-defined results that contain the  symbol.

14.6 PROFINET®

PROFINET®²⁵ is a data communication protocol for industrial automation and processes. PROFINET IO defines how controllers (IO controllers) and peripheral devices (IO devices) exchange data in real time.

The VE Series Smart Camera supports PROFINET IO. The data communication protocol is TCP/IP; the data transmission medium is copper wire; the PROFINET conformance class is CC-A.²⁶



Note: In this document, outputs from the VE device are referred to as "inputs" to the controller (PLC). Outputs from the controller (PLC) are referred to as "inputs" to the VE device.

14.6.1 General Station Description (GSD) File

The General Station Description (GSD) file contains module information, such as:

- Configuration data
- Data information (pass count, inspection status, etc.)
- Diagnostics

14.6.2 PROFINET IO Data Model

The PROFINET IO data model is based on the typical, expandable field device that has a backplane with slots. Modules and submodules have different functionalities.

Modules are plugged into slots; submodules are plugged into subslots. In the PROFINET IO data model, Slot 0 Subslot 1 is reserved for the Device Access Point (DAP) or network interface.

Both modules and submodules are used to control the type and volume of data that is sent to the controller (PLC).

- A submodule is typically designated as input type, output type, or combined input/output type
- An input submodule is used to send data to the controller (PLC)
- An output submodule is used to receive data from the controller (PLC)
- The combined input/output submodule simultaneously receives and sends data in both directions

14.6.3 Configure the VE Series Smart Camera for a PROFINET IO Connection

The VE Series camera and the controller (PLC) must be configured for PROFINET®.

1. On the  **System Settings** screen, select **Communications**, then select the **Industrial Protocols** tab.
2. Select **PROFINET** from the **Protocol** list.
The sensor configuration is complete. Configure the PLC to complete the PROFINET connection.

²⁵ PROFINET® is a registered trademark of PROFIBUS Nutzerorganisation e.V.

²⁶ CC-A ensures that the device has the minimum properties regarding functionality and interoperability.

The default PROFINET configuration consists of a single module plugged into Slot 1. This module, called the Device Control and Status Module, accepts two submodules: the Inspection Result Submodule, plugged into Subslot 1, and the Device Control Submodule, plugged into Subslot 2.

The Inspection Result Submodule provides the inspection results from the VE Series camera, including Pass Count, Fail Count, and Current Inspection Time. See [Table 30](#) on p. 219.



Note: The Inspection Result Submodule does not provide any sensor-specific output data.

The Device Control Submodule allows the user to issue commands to the VE, such as Trigger, TEACH, and Product Change. This submodule also provides the user with command feedback. See [Table 31](#) on p. 220.

14.6.4 Description of Modules and Submodules

Table 26: Module Slot Assignment

	Module
Slot 1	VE Control and Status Module
Slot 2	VE Output Module
Slot 3	VE Input Module

Table 27: VE Control and Status Module (Ident 0×000010)

	Submodule	Notes
Subslot 1	VE Inspection Results Submodule (see VE Inspection Results Submodule on p. 219)	Always present.
Subslot 2	VE Device Control Submodule (see VE Device Control Submodule on p. 220)	Present by default, but can be removed.

Table 28: Sensor Output Module (Ident 0×000040)

	Submodule	Notes
Subslot 1	Sensor output submodules (various) (see Sensor Output Submodules on p. 224)	There are six versions of this submodule supporting payloads of 16, 32, 64, 128, 256, and 512 bytes.

Table 29: Sensor Input Module (Ident 0×000041)

	Submodule	Notes
Subslot 1	Sensor input submodules (see Sensor Input Submodule on p. 225)	This module is input only.

14.6.5 Description of Submodules

VE Inspection Results Submodule

The VE Inspection Result submodule contains inspection results and sends input data into the controller (PLC). This submodule is plugged into Slot 1 Subslot 1 and cannot be removed.

Table 30: VE Inspection Result Submodule (Ident 0x000101)

PLC Input Data Name	Input Data Type	PLC Output Data Name	Output Data Type
Inspection Status Word	Unsigned16	Not applicable	Not applicable
Inspection Number	Unsigned32		
Sensor Pass/Fail Bits	Unsigned32		
Iteration Count	Unsigned32		
Pass Count	Unsigned32		
Fail Count	Unsigned32		
Missed Trigger Count	Unsigned32		
Current Inspection Time	Unsigned32		

Inspection Status Word	
Bit Position for Cyclic Input Data	Function
Bit 0	System Ready
Bit 1	Inspection Pass/Fail
Bit 3	Ready Signal Latch
Bit 5	Output 1 ON/OFF
Bit 6	Output 2 ON/OFF
Bit 7	Output 3 ON/OFF
Bit 8	Output 4 ON/OFF
Bit 9	Output 5 ON/OFF

Sensor Pass/Fail Bits	
Bit Position	Function
Bit 0	Camera Tool Pass/Fail
Bit 1	Vision Tool 1 Pass/Fail
...	...
Bit 32	Vision Tool 31 Pass/Fail

VE Device Control Submodule

The VE Device Control Submodule contains controller (PLC) input and output data, including device controls for the VE. The Device Control Submodule is plugged into Slot 1, Subslot 2 by default but it can be removed.

Table 31: VE Device Control Submodule (Ident 0x000001)

Byte #	PLC Input Data Name	Input Data Type	Byte #	PLC Output Data Name	Output Data Type
0 - 1	Device Control ACK Word	Unsigned16	0 - 1	Device Control Command Word	Unsigned16
2 - 5	Return Error Code	Unsigned32	2 - 5	Product Change Number	Unsigned32

Device Control ACK Word	
Bit Position for Cyclic Input Data	Function
Bit 0	Product Change Acknowledgement
Bit 1	Teach Latch Acknowledgement
Bit 2	Trigger Acknowledgement
Bit 6	Barcode Data Compare Input String Acknowledgement
Bit 7	FTP Input String Acknowledgement
Bit 13	Teach Error
Bit 14	System Error
Bit 15	Command Execution Error

Device Control Command Word	
Bit Position for Cyclic Output Data	Function
Bit 0	Product Change Request
Bit 1	Teach Latch Request
Bit 2	Trigger Request
Bit 6	Barcode Data Compare Input String
Bit 7	FTP Input String

The following rules apply for the use of input bit commands:

- Only one VE Series camera input bit can be set at a time
- Corresponding ACK bits are set high only on completion of the command (if the VE input bit is still high)
- Corresponding ACK bits are cleared when the VE input bit is cleared
- When multiple VE input bits are set simultaneously, the Execution Error input bit is set and an Error Code value is reported in the Error Code register
- The Execution Error VE output bit is cleared when all ACK bits are cleared, or a new valid command is received

Figure 371. Trigger—PROFINET

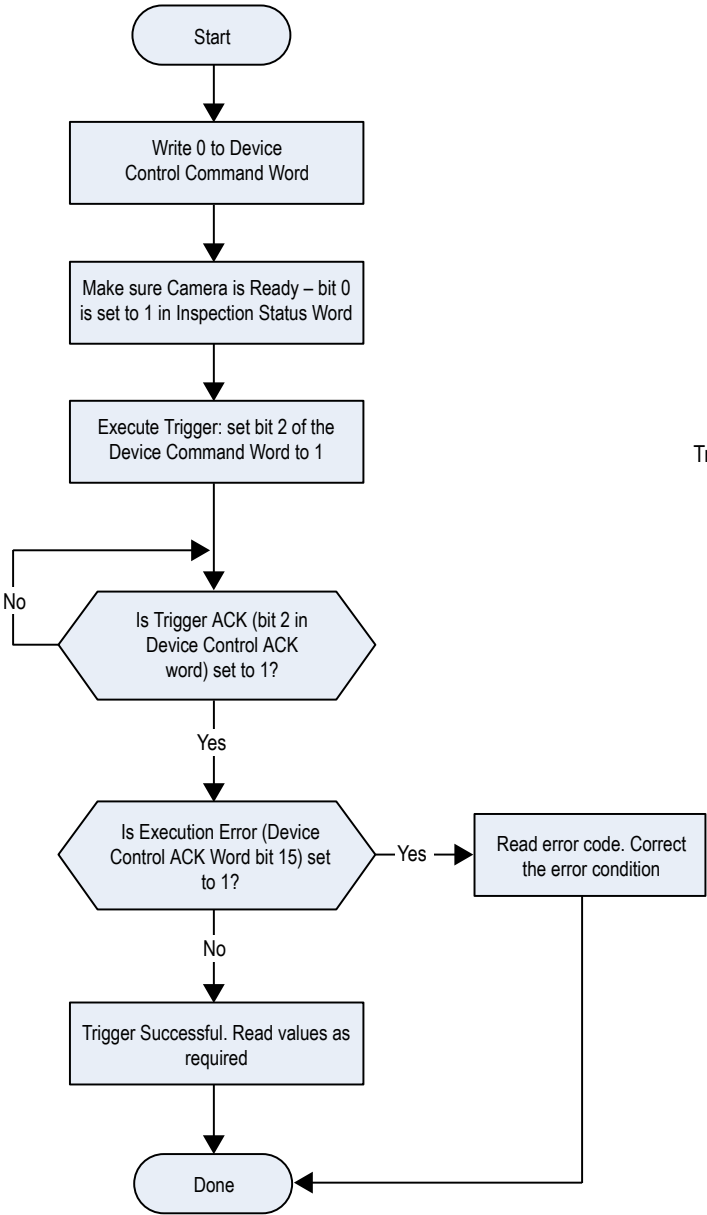

Figure 372. Trigger Timing Diagram

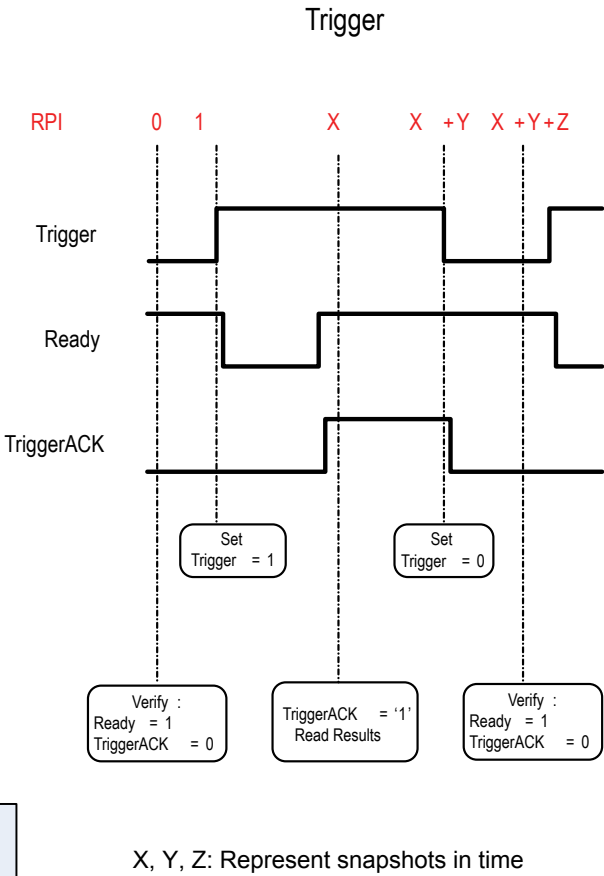

Figure 373. TEACH—PROFINET

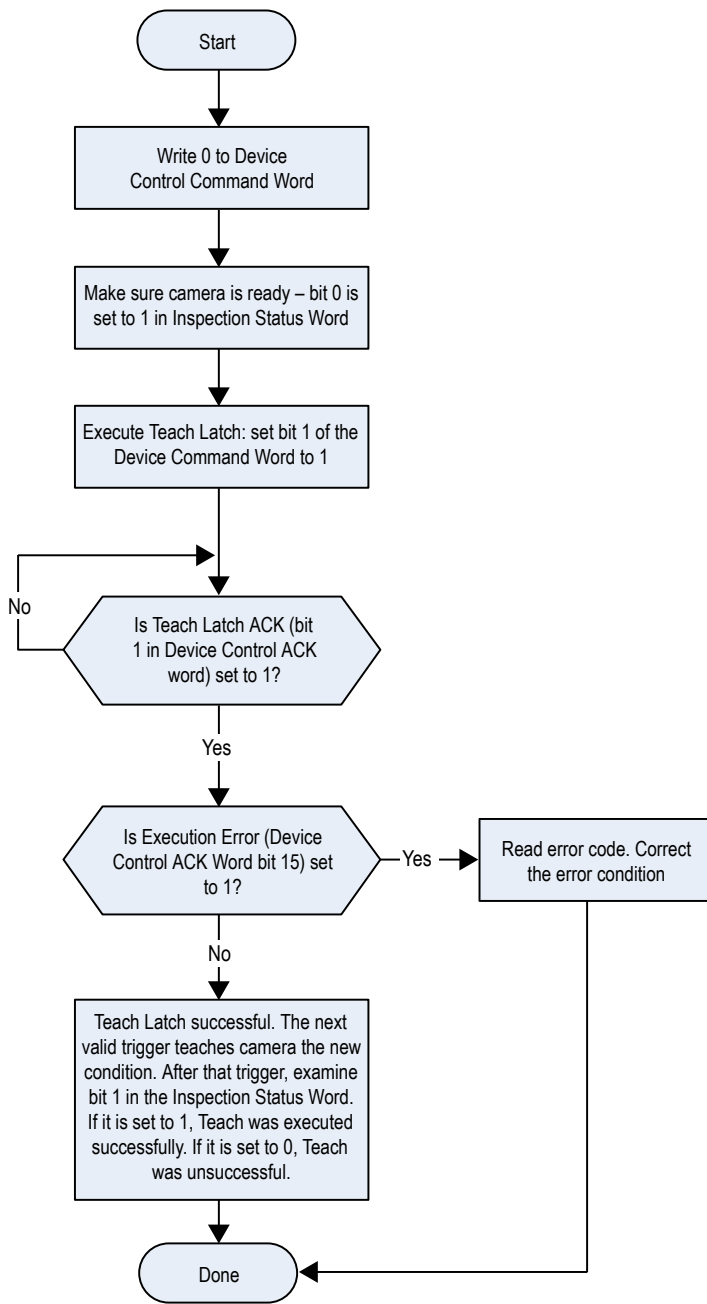

Figure 374. Teach Latch Timing Diagram

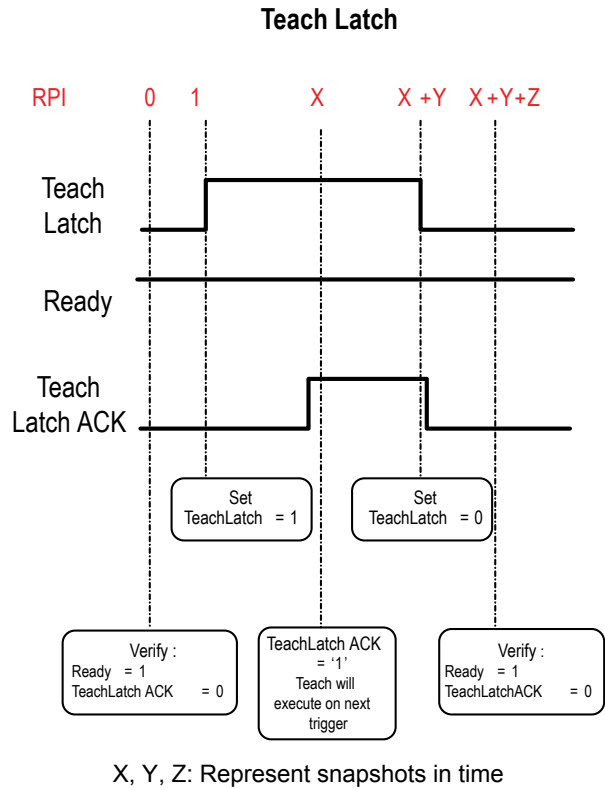

Figure 375. Product Change—PROFINET

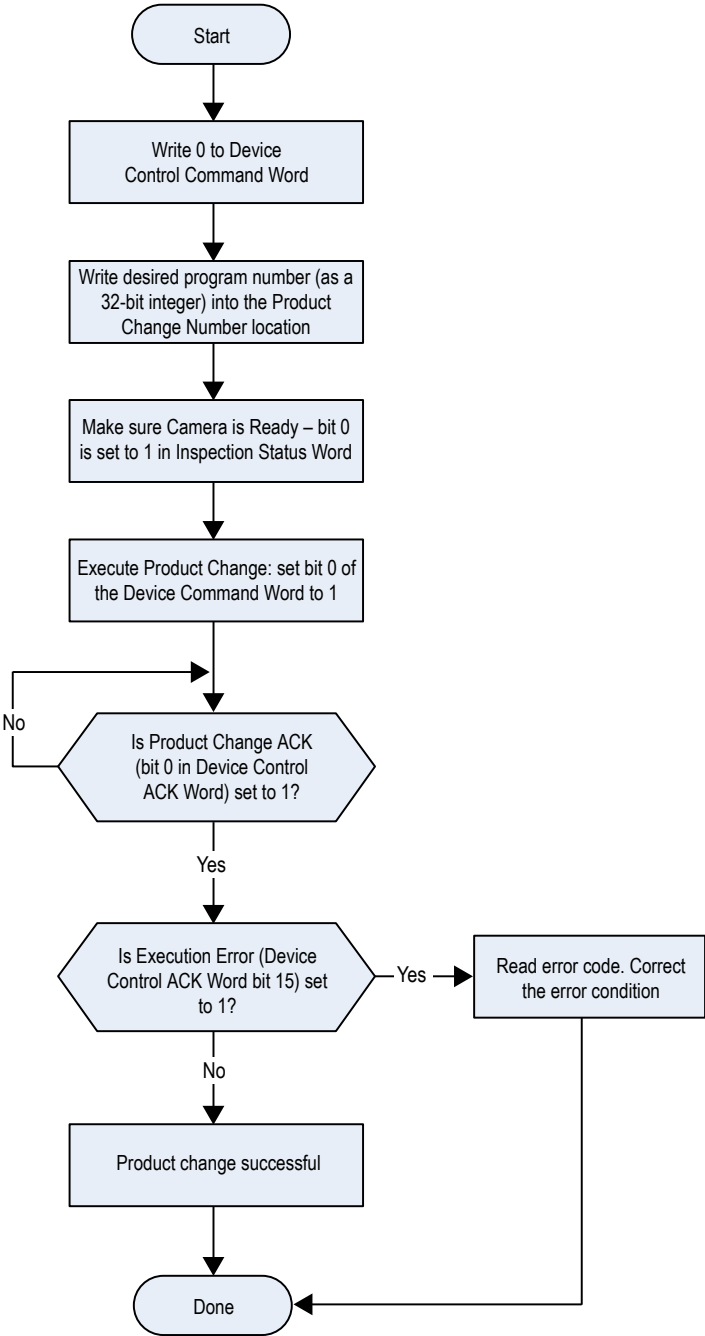
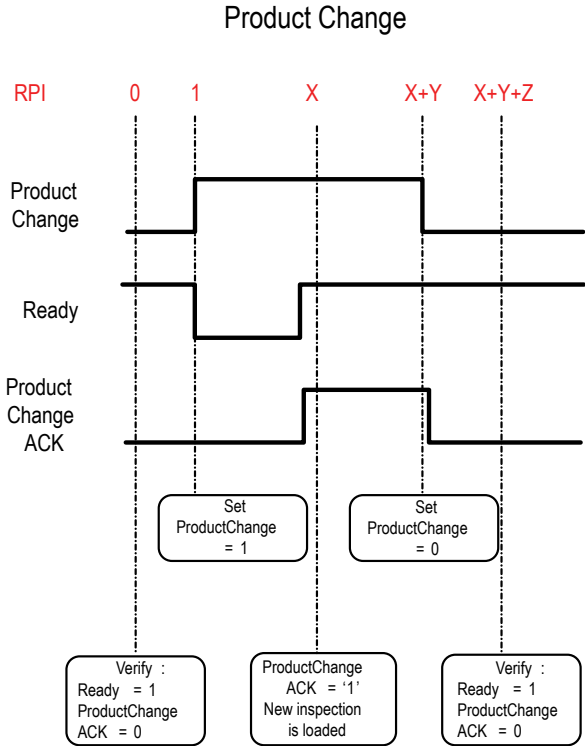

Figure 376. Product Change Timing Diagram



X, Y, Z: Represent snapshots in time

Sensor Output Submodules

The Sensor Output Submodules contain user-defined maps of sensor output data. There are six versions with 16, 32, 64, 128, 256, and 512 bytes, depending on the size of the output data. A sensor output submodule can be added to slot 2, subslot 1.

Table 32: Sensor Output Submodule

Submodule		PLC Input Data		PLC Output Data	
Name	Ident No.	Name	Type	Name	Type
16-Byte Custom Map	0x000028	User-mapped Sensor Result Data Block	16-byte OctetString	Not applicable	Not applicable
32-Byte Custom Map	0x000029	User-mapped Sensor Result Data Block	32-byte OctetString	Not applicable	Not applicable
64-Byte Custom Map	0x000030	User-mapped Sensor Result Data Block	64-byte OctetString	Not applicable	Not applicable
128-Byte Custom Map	0x000031	User-mapped Sensor Result Data Block	128-byte OctetString	Not applicable	Not applicable
256-Byte Custom Map	0x000032	User-mapped Sensor Result Data Block	256-byte OctetString	Not applicable	Not applicable
512-Byte Custom Map	0x000033	User-mapped Sensor Result Data Block	512-byte OctetString	Not applicable	Not applicable

Tool-Specific Results: PROFINET

Configure the VE to output user-defined, tool-specific results to the PLC using a custom map.

The sensor output submodule includes both system-defined and user-defined results in the map. To set the user-defined, tool-specific results, navigate: **System Settings > Communications > Industrial Protocols**.

Figure 377. Industrial Protocols Tab—PROFINET

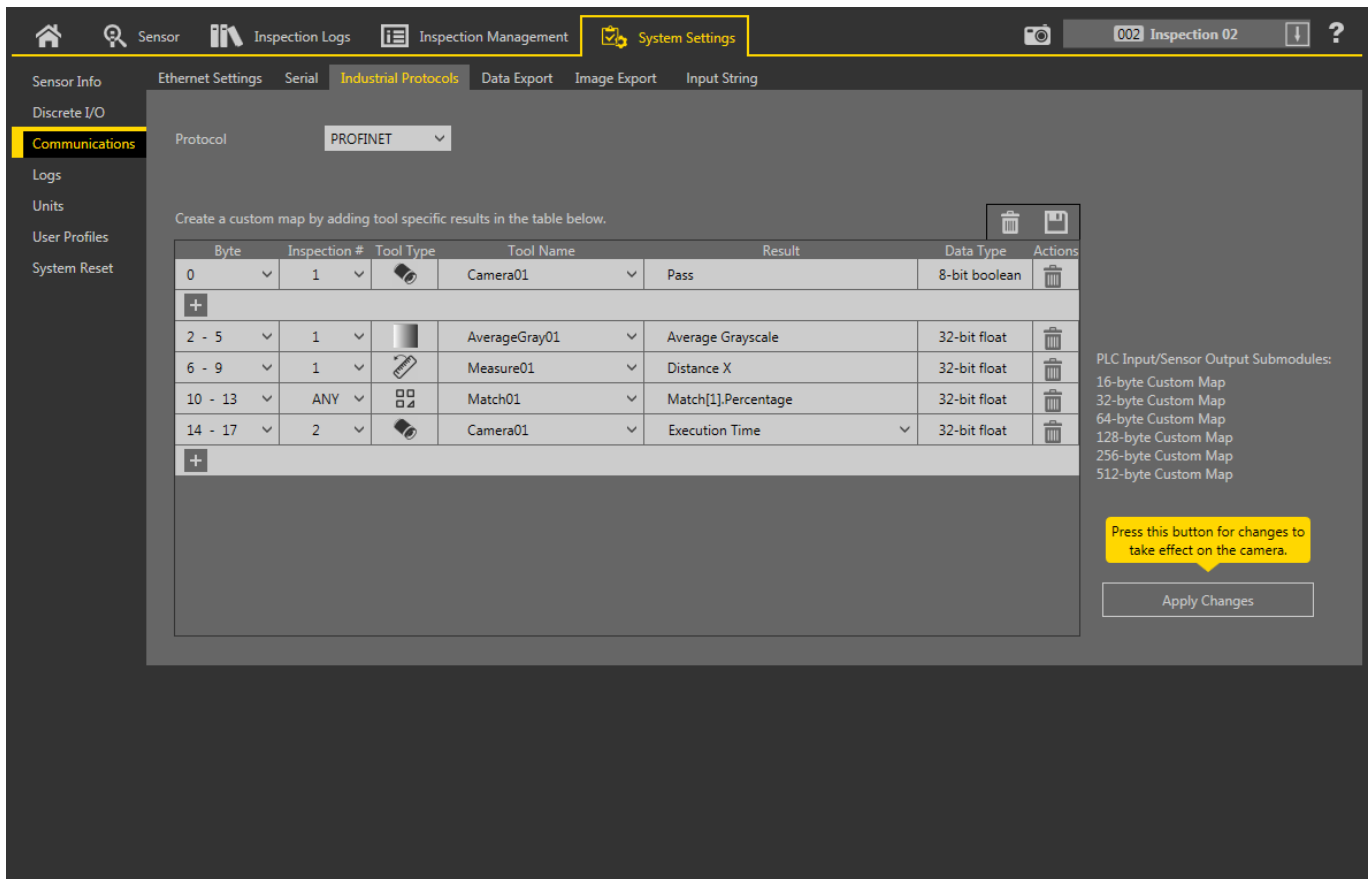



The results are configurable only for the current inspection. However, all user-defined results in the custom map are shown on the Industrial Protocols tab whether or not they are included in the current inspection. To make changes to a different inspection, switch to the desired inspection and then make changes to the custom map. Updating the map does not disconnect the sensor from the PLC.

To configure the map:

1. Click  to add a new line to the map.
2. Set the Word/Register/Byte, Tool Name, and Result. See the following descriptions for more information.
3. Click **Apply Changes** to send the current map to the camera.



Important: Click **Apply Changes** or all user-defined data is lost when you click away from the **Industrial Protocols** tab.

4. Click  to print and save a PDF of the current map. The PDF includes all data, whether system-defined or user-defined.
5. To return the map to the default settings, click . All user-defined output data is deleted.

Column descriptions:

Byte

The data location.

Inspection

Shows whether this tool result applies to the current inspection only (*inspection number*) or to any inspection (ANY) that includes the selected tool.

An Inspection # of ANY means that if an inspection includes a tool with the exact name (for example, *AverageGray01*), the results are output. If an inspection does not have a tool with the exact name (for example *AverageGrayAssemblyLine01*), no results are output for that tool and that inspection.

Tool Type

Displays a graphic that represents the type of tool selected in the Tool Name column.

Tool Name

Select the desired Tool Name from the list. The list includes the tools available in the current inspection only. Select a different inspection from the inspection list, if necessary.

Result

The information to output.

Data Type

The type of information to output.

Actions

Click  to delete a result.

Sensor Input Submodule

Ident 0x000130

Table 33: **Sensor Input Module Definition for FTP File Name Control**

Byte #	PLC Data Name	Data Type
0 - 3	Input String Length	32-bit integer
4 - 55	Input String	String (52 Characters)

Table 34: **Sensor Input Module Definition for Tool Input String Control**

Byte #	PLC Data Name	Data Type
0 - 1	Tool Index	16-bit integer
2 - 3	Input String Length	16-bit integer
4 - 55	Input String	String (52 Characters)

To use this submodule for FTP Filename control, the **Industrial Protocol String** checkbox must be selected. See [Image Export: FTP](#) on p. 173.

To use this submodule for setting the Barcode Data Compare String, the **Data Compare** checkbox on the **Test** tab must be selected. See [Barcode Tool: Test Parameters](#) on p. 145.

Note that you can switch back and forth between FTP File Name Control and Tool Input String Control as desired.

14.6.6 Configuration Instructions

Using Siemens TIA Portal (v13) Software

Installing the GSD File

Use these instructions to install the GSD file in the Siemens TIA Portal (v13) software. Use these instructions as a basis for installing the GSD file in another controller (PLC).

1. Start the Siemens TIA Portal (v13) software.
2. Click **Open existing project**.
3. Select a project and open it.
4. Click **Devices & networks** after the project has been uploaded.

Figure 378. Devices and Networks

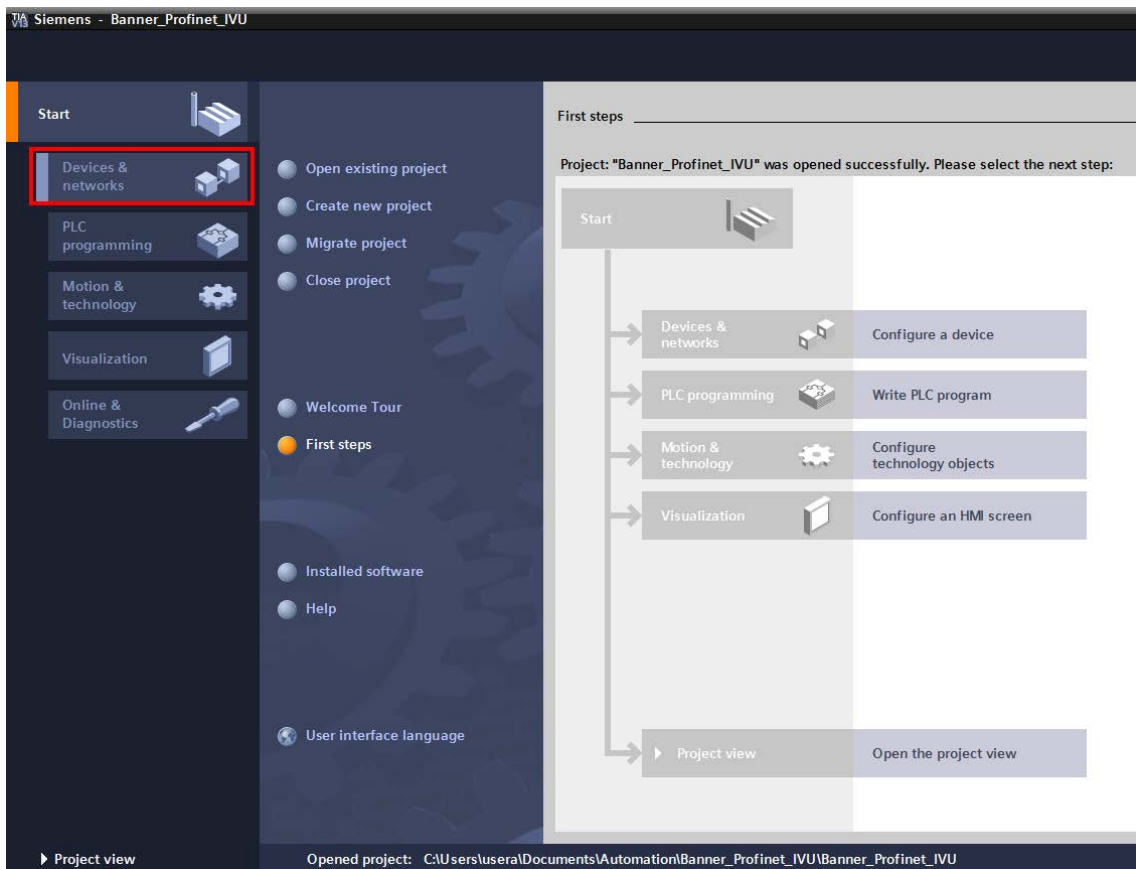

5. Click **Configure networks**.

Figure 379. Configure Networks



Network view displays.

- Click **Options** and select **Manage general station description file (GSD)**.

Figure 380. Options—Install the GSD

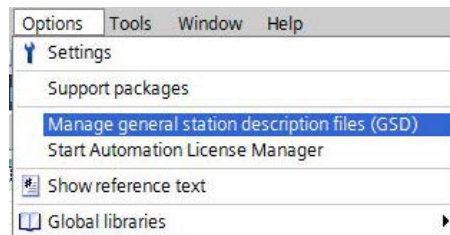

The **Install general station description file** window opens.

- Click the browse button (...) to the right of the **Source path** field.

Figure 381. Manage GSD Files

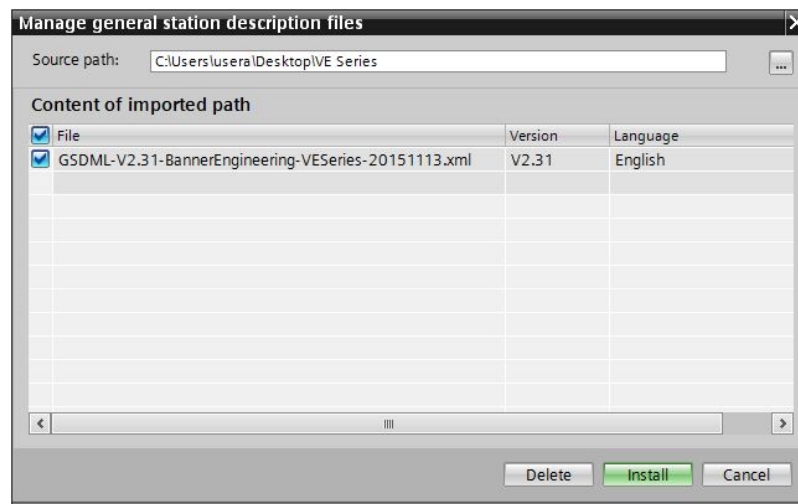

- Navigate to C:\Users\Public\Documents\Banner Vision Manager\VE Series\Industrial Protocols\Profinet.
- Select the VE GSD file.
- Click **Install**.

Figure 382. Hardware Catalog

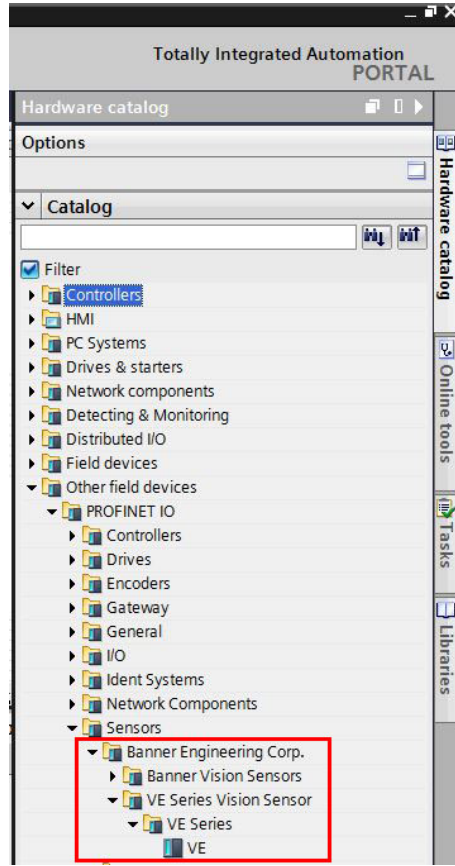

The system installs the VE GSD file and places it in the **Hardware catalog**. In the above example, the VE GSD file is located under **Other field devices > PROFINET IO > Sensors > Banner Engineering Corp. > Banner Vision Sensors > VE Series Vision Sensor > VE Series > VE**.



Note: If the VE GSD file does not install properly, save the log and contact Banner Engineering Corp.

Adding a Device to a Project

Use these instructions to add a VE Series camera device to a Siemens TIA Portal (v13) project, and to configure the device. Use these instructions as a basis for adding a VE Series camera device to another controller (PLC).

1. Start the Siemens TIA Portal (v13) software.
2. Click **Open existing project**.
3. Select a project and open it.
4. Click **Devices & networks** after the project has been uploaded.

Figure 383. Devices and Networks

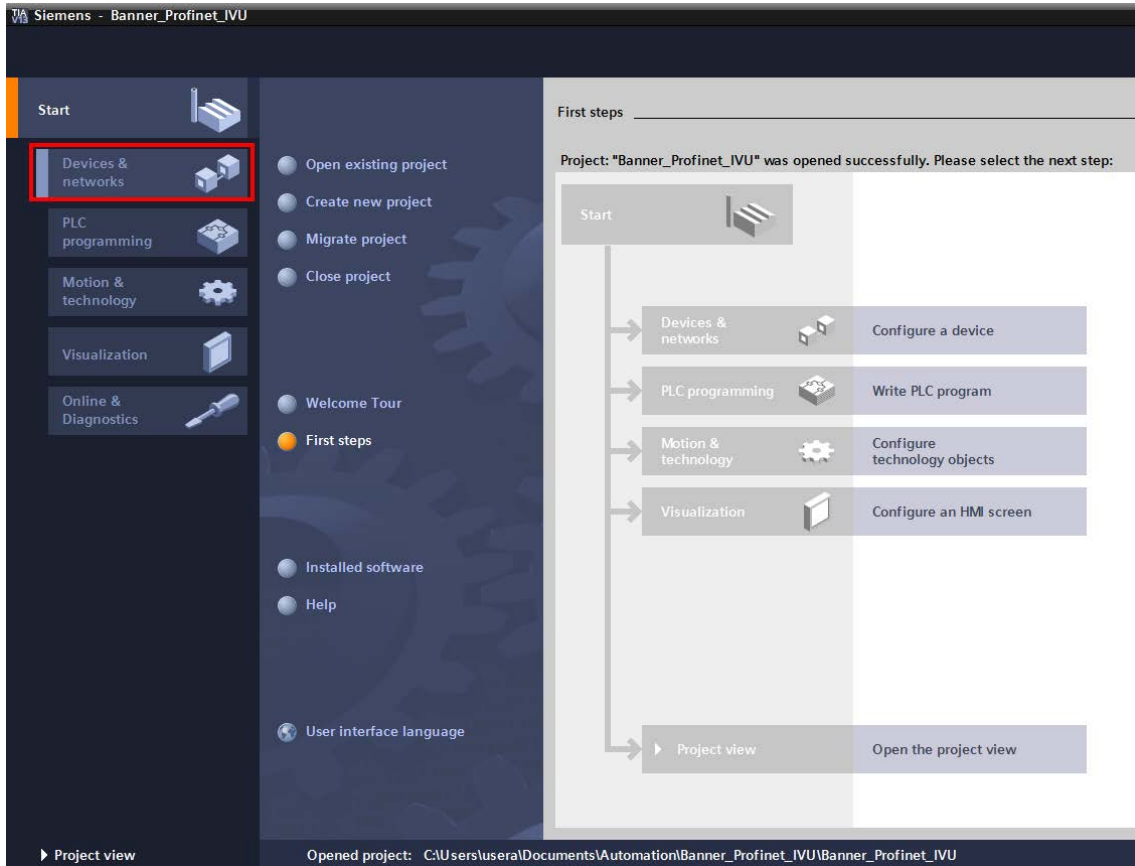

5. Click **Configure networks**.

Figure 384. Configure Networks

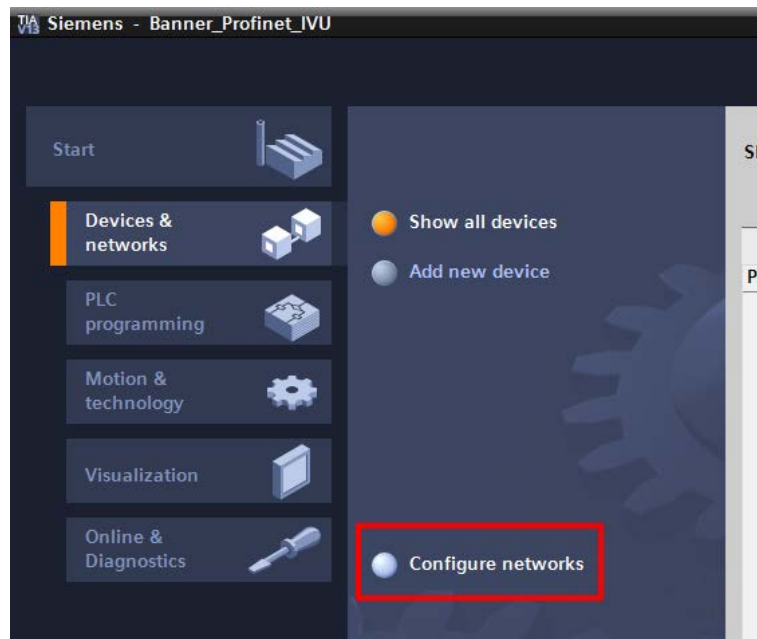

Network view displays.



Note: For Step 6 through Step 10, **Network view** must be open.

6. Locate the VE Series camera in the **Hardware catalog**.

Figure 385. Hardware Catalog

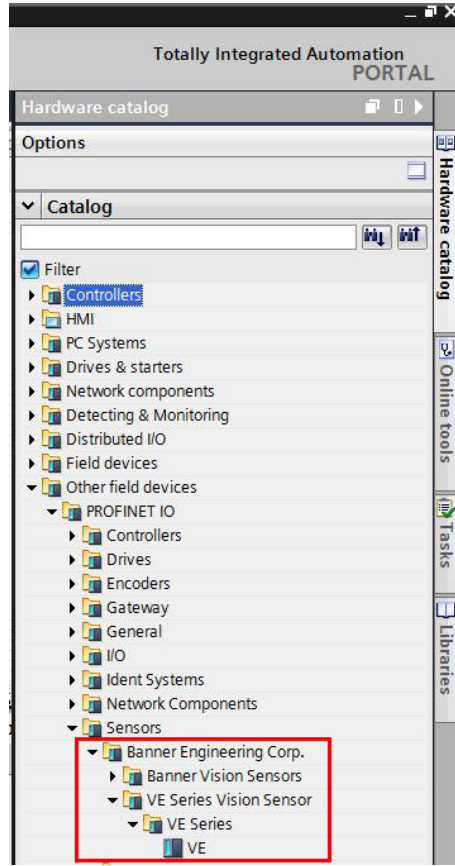

In the above example, the VE device is located under **Other field devices > PROFINET IO > Sensors > Banner Engineering Corp > Banner Vision Sensors > VE Series Vision Sensor > VE Series > VE**.

7. Select the device and add it to the configuration.

Selection Option **Description**

Drag Drag the VE from the **Hardware catalog** directly into the configuration.

Double-click Double-click on the VE and add it to the configuration.

8. Click the green square on the VE icon. Drag the pointer to the green square on the PLC_1 icon to connect the device to the controller (PLC).

Figure 386. Drag to Connect

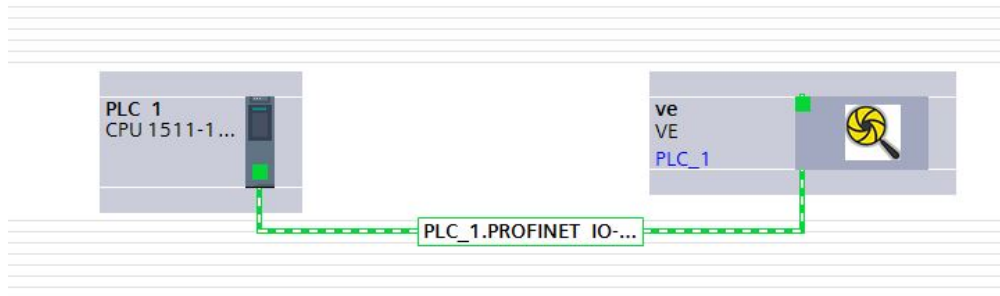

The connection is made.

9. Double-click the VE icon to open the **Device** window.
10. Select the desired modules or submodules from the **Hardware catalog** and drag them onto the **Device overview** tab on the **Device view** tab. The VE device is configured.

Changing the Device IP Address

Use these instructions to change the IP address of the VE device, using the Siemens TIA Portal (v13) software. Use these instructions as a basis if you are using another controller (PLC).

1. Start the Siemens TIA Portal (v13) software.
2. Click **Open existing project**.
3. Select a project an open it.
4. Click **Devices & networks** after the project has been uploaded to go to **Network view**.

Figure 387. Network View

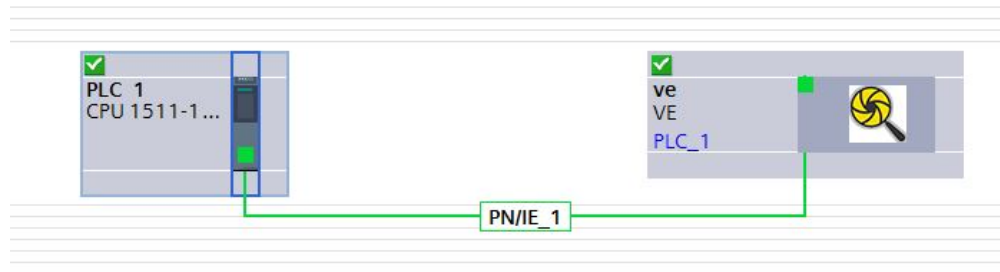

Network View displays.

5. Double-click on the VE icon to open the **Device view**.
6. Click on the VE icon in the graphic area of the **Device view** to open the **Module properties** window. The module can now be configured.
7. Click **Properties**.
8. Click **General**.
9. Select **PROFINET interface > Ethernet addresses**.

Figure 388. Ethernet Addresses

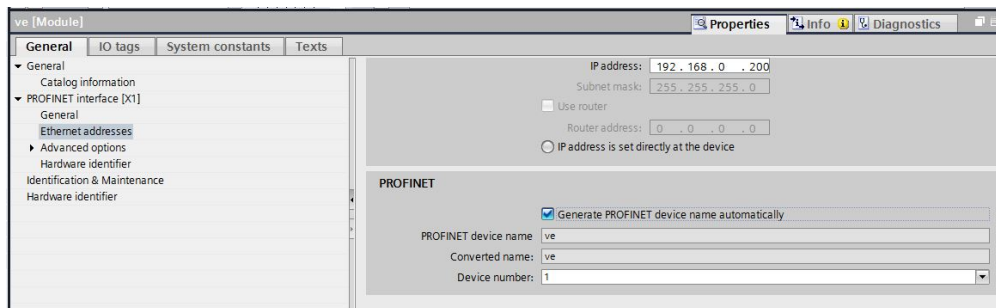

10. Select **Set IP address in the project**.

Figure 389. Set IP Address

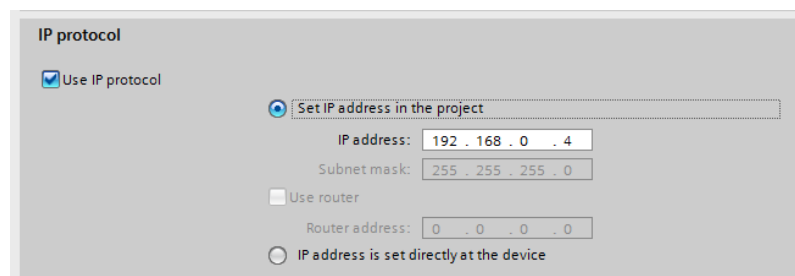

The project sets the IP address of the device.

11. Enter the IP address.
12. Right-click on the device icon and select **Online & diagnostics**.

Figure 390. Select Online & Diagnostics

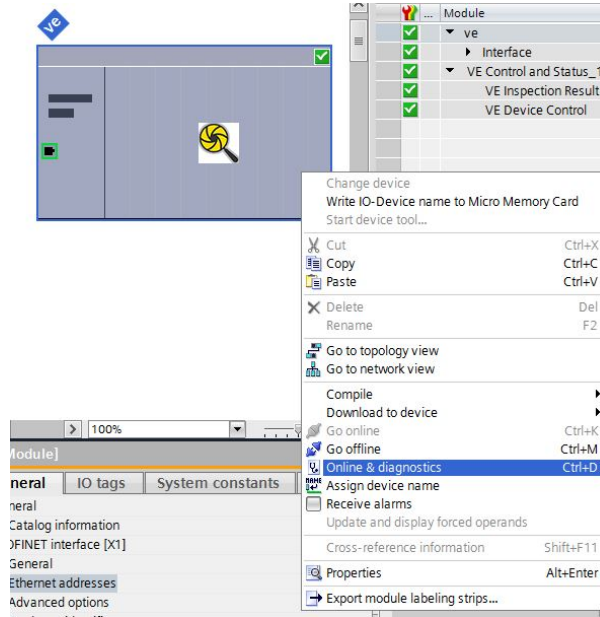
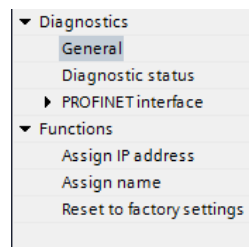
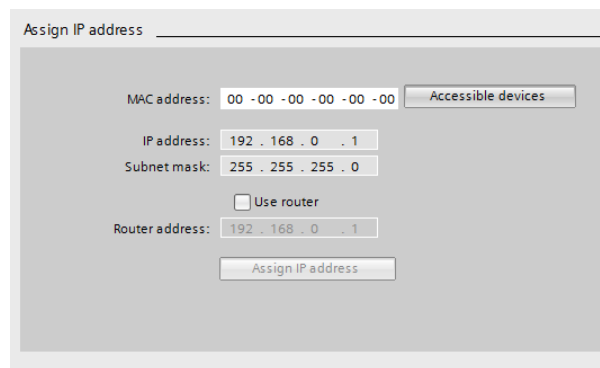

Figure 391. Online & Diagnostics



- The **Online & diagnostics** window displays.
13. Select **Assign IP address** under **Functions**.
 14. Click **Accessible devices**.

Figure 392. Assign IP Address—Accessible Devices



- The **Select device** window searches the network for available devices.
15. Determine the device to be adjusted via the MAC address and select it.



Note: Use the Vision Manager software to find the MAC address: **Home > Sensor Neighborhood > Active Sensors**.

16. Click **Apply**.

Figure 393. Select the Device and Apply Changes

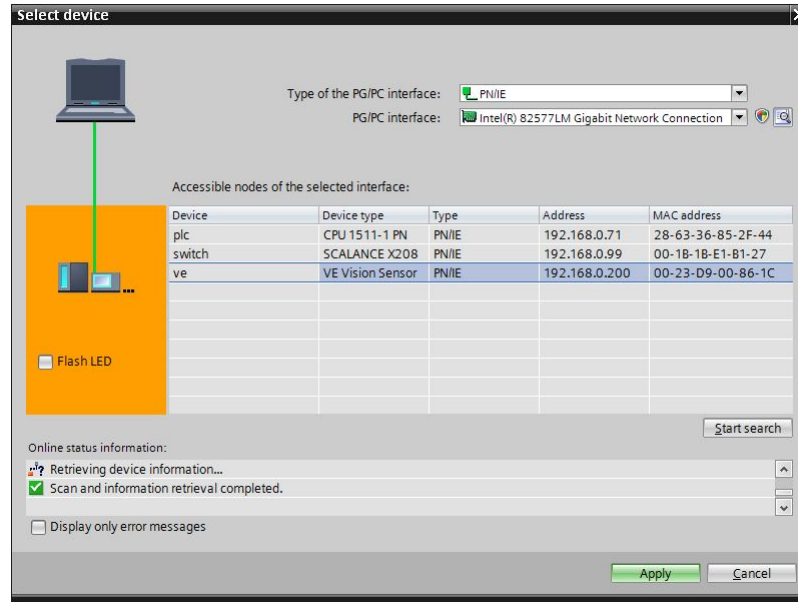

The IP address for the device is updated.

17. Click **Assign IP address** to complete the step.

This step is completed for every device.

Note: PROFINET devices commonly lack an IP address on startup (IP address = all zeros). However, VE devices require an IP address to connect to Vision Manager to set the device configuration.

By default, each camera shipped from the factory is assigned the IP address 192.168.0.1. The default address can be changed using Vision Manager.

Immediately after the PROFINET protocol has been enabled in the camera, but before the PLC discovers and connects to the camera, the camera will retain its IP address. After the PLC discovers and connects to the camera, the behavior of the IP address depends on how the PLC was configured to assign the camera IP address. Two configuration options are available.

Figure 394. Siemens TIA Portal (v13): IP Protocol Options

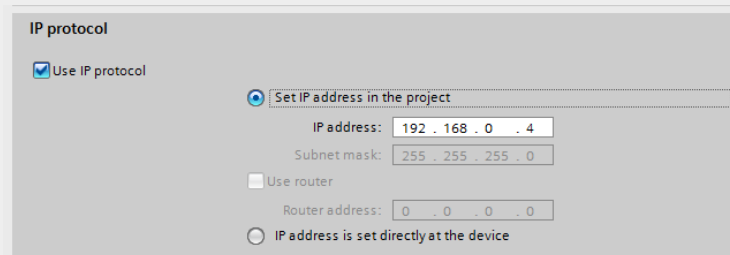

- The IP address is set in the project: If the PLC is told to assign the camera IP address (for example, using the **Set IP address in the project** option in Siemens TIA Portal), the camera receives the specified address, but only after the program has been loaded into the PLC and is running.

If the camera is restarted after it was discovered and configured by the PLC, the camera has an IP address of 0.0.0.0 until the PLC discovers it and assigns it the specified address again.

When the camera has no IP address assigned, it is still possible to assign an IP address to the camera using Vision Manager. However, if this address is different than what is specified in the PLC, the camera reverts to the address specified in the PLC when the PLC becomes active again.

- The IP address is set at the device: If the PLC is told that the camera IP address is configured at the device (for example, using the **IP address is set directly at the device** option in Siemens TIA Portal), the camera always retains the IP address that was assigned to through Vision Manager.

These configuration options conform to the PROFINET standard.

Changing the Device Name

Use these instructions to change the name of the VE device, using the Siemens TIA Portal (v13) software. Use these instructions as a basis if you are using another controller (PLC).

1. Open a project and click on **Devices & networks** to go to the **Network view**.

Figure 395. Network View

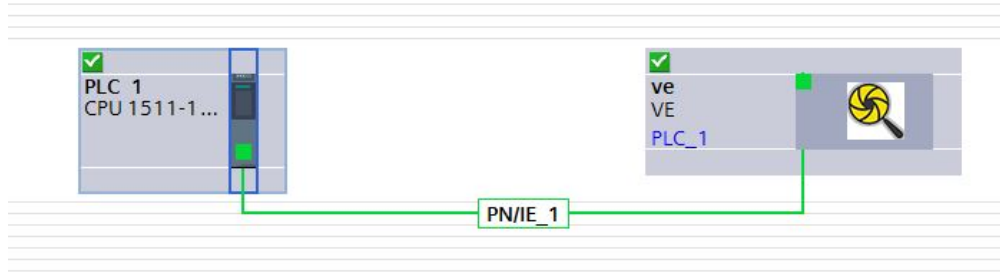

Network view displays.

2. Double-click on the VE icon to open **Device view**.
3. Click on the VE icon in the graphic area of **Device view** to open the **Module properties** window.
4. Click **General**.
5. Select **PROFINET interface [X1] > Ethernet addresses**.

Figure 396. Ethernet Addresses

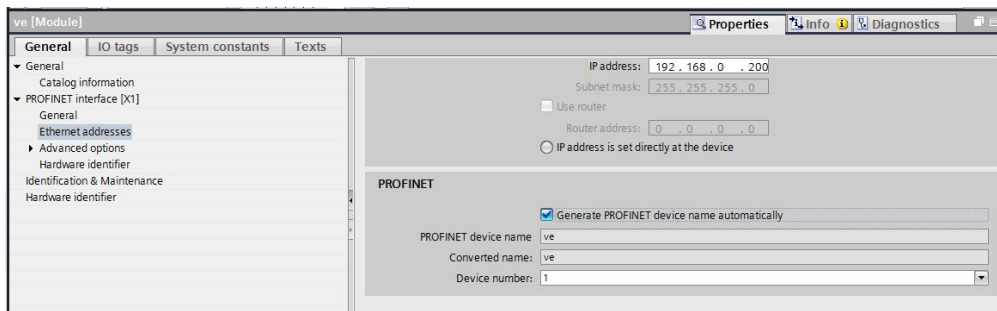

6. Deselect **Generate PROFINET device name automatically**.

Figure 397. PROFINET Device Name

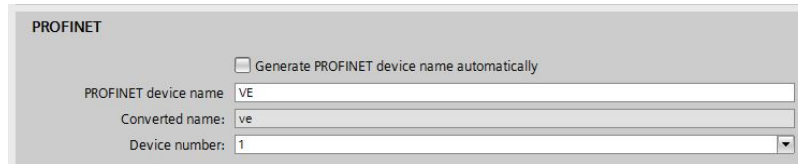

7. Enter a unique name in the **PROFINET device name** field.
8. Enter a unique device number in the **Device number** field.



Note: Each device number is used only once.

9. Right-click on the device icon and select **Online & diagnostics**.

Figure 398. Select Online & Diagnostics

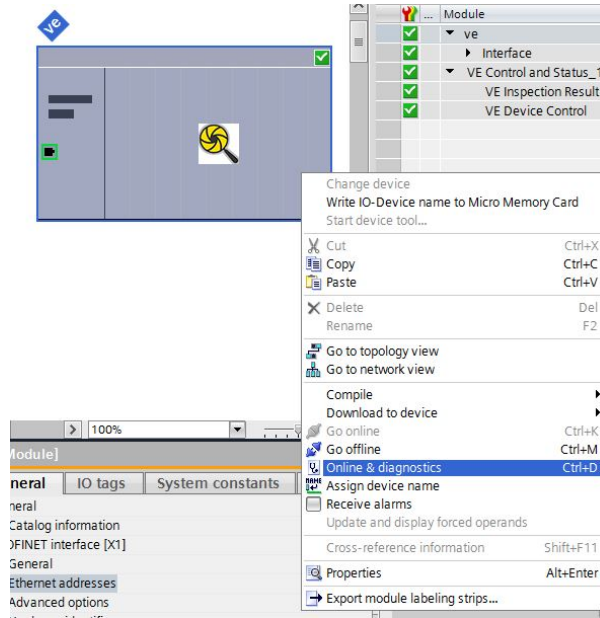
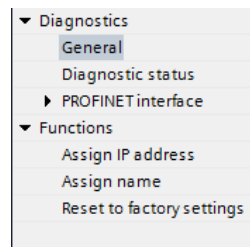

Figure 399. Online & Diagnostics



The **Online & diagnostics** window displays.

10. Select **Assign name** under **Functions**.
The **Assign name** window displays. The devices in the network are discovered.
11. Select the device that will have a name assigned to it.
12. Click **Assign name** to start the process.
The name is assigned.

Figure 400. Assign Name

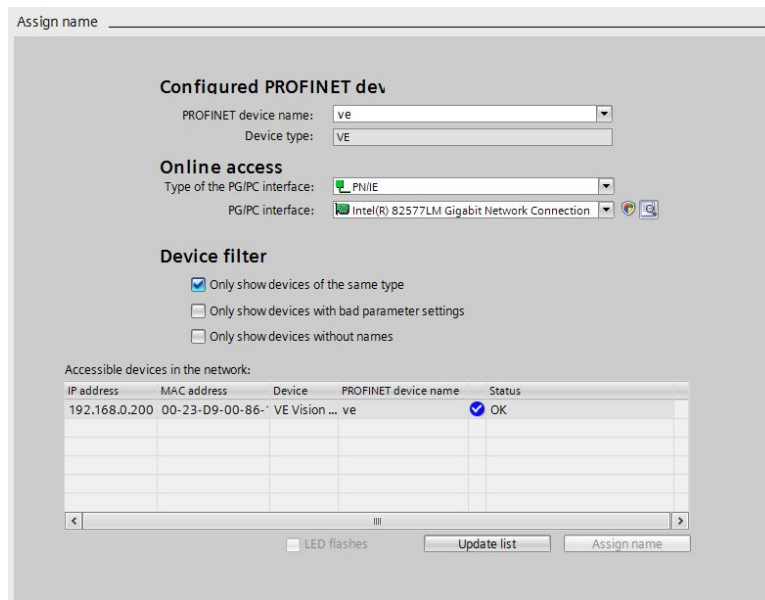

14.7 Troubleshooting

14.7.1 Industrial Ethernet Error Codes

The VE Series camera provides error codes when coil bit commands fail to execute successfully.

If such an error occurs, the Execution Error flag is set in the Output Bits/Status Register. When this bit is set, read the Error Code register to know the reason for the failure.

Error Code	Text ID	Description	Recommended Solution
520	IE_COIL_ACTION_FAILED	The coil action resulted in a failure.	Clear all coil bits. Verify that the corresponding acknowledgement bits are reset to zero. The error code clears when the next valid command is issued. Make sure the related data is set correctly. For example, the Input String Length must be > 0 for Input String coil actions.
521	IE_COIL_ALREADY_BUSY	The coil was asserted before the previous execution completed.	Verify that the corresponding acknowledgement bit gets set. Then clear all coil bits and try again.
522	IE_COIL_NOT_FINISHED	The coil was de-asserted prior to the execution completing.	Verify that the corresponding acknowledgement bit gets set. Then clear all coil bits and try again.
523	IE_COIL_ANOTHER_ACTION_PENDING	The coil was asserted prior to another coil execution completing.	Verify that the corresponding acknowledgement bit gets set. Then clear all coil bits and try again.
524	IE_COIL_MULTIPLES_DETECTED	Multiple coils were asserted simultaneously.	Clear all coil bits. Verify that the corresponding acknowledgement bits are reset to zero. The error code clears when the next valid command is issued.
525	IE_COIL_ACK_INHIBITED	The coil action's output ACK was inhibited because the input coil was no longer set.	Keep the corresponding coil bit set during the execution period.
10252	COMMAND_NOT_FINISHED	Attempt to issue command when a previous command has not finished	Wait for acknowledgement of the previous command before issuing a new command.
10900	SENSOR_NOT_READY	Command specified requires the device to be in the READY state.	Verify that the sensor bootup or product change operation is complete. Use of ONLINE output signal is recommended.
80200	SYSTEM_ERROR_NOT_ACTIVE	The System Error must be active to execute this command	When no system error is active, do not set the bit to clear system errors.
80300	TEACH_SENSOR_TYPE_INVALID	Teach requires Match sensor.	Execute a teach command only when a Match tool is present in the currently running inspection.
80400	PRODUCT_CHANGE_WHEN_NOT_READY	The sensor must be in the Ready state to perform a product change.	Clear the Product Change bit. Verify that the Product Change acknowledgement bit has been reset to zero. Wait until the sensor is Ready. Re-assert the Product Change bit.
80401	PRODUCT_CHANGE_INVALID_INSPECTION	Attempt to product change to a unknown or invalid inspection.	Clear the Product Change bit. Verify that the Product Change acknowledgement bit has been reset to zero. Set the inspection slot to a valid value. Re-assert the Product Change bit.
80403	PRODUCT_CHANGE_TO_SAME_INSPECTION	Attempt to product change to the same inspection.	Product change to a different inspection.
80410	SET_DATACOMPARE_STRING_FAILED	Attempt to set the Barcode Data Compare string failed.	Make sure the Barcode tool being edited exists in the current inspection.

14.7.2 PROFINET

Discovering VE Series camera Devices

The Siemens TIA Portal (v13) software discovery and configuration protocols are used to discover VE Series camera devices on a network.

1. Start the Siemens TIA Portal (v13) software.
2. Click **Open an existing project**.
3. Select a project and open it.
4. Click **Devices & networks** after the project has been uploaded.
5. Click **Configure networks**.
- 6.



Click the **Accessible devices** icon.

The **Accessible devices** window opens.

7. Select an interface connection in the **Type of the PG/PC interface** list.
8. Select an interface connection in the **PG/PC interface** list.

Figure 401. PG/PC Interface

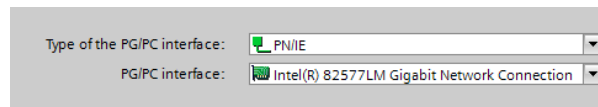

The PC scans the network for PROFINET® devices. If the device you are looking for is not present, check the cabling.

Example of Scanning Results

Under **Online status information**, the scan shows that three devices were found.

Figure 402. Select Device—Online Status Information

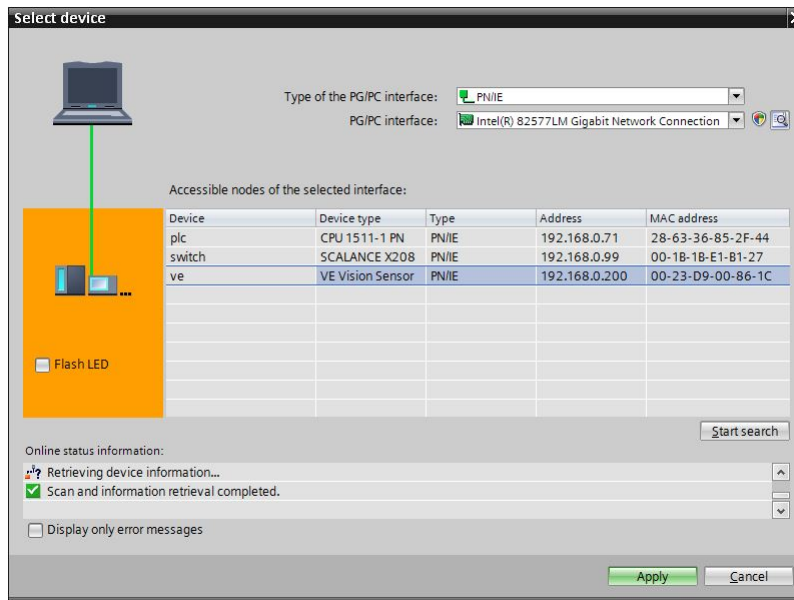

Diagnosing Errors

The Siemens TIA Portal (v13) software includes numerous diagnostic tools. When a computer is connected to the controller (PLC), diagnostic information is available. The controller (PLC) generates a message that displays in the **Diagnostics** window. A flashing red light on the CPU module of the controller (PLC) indicates an error.

1. Click on the text in the **Details** column to request detailed information about the device that caused the error.

Figure 403. Diagnostics

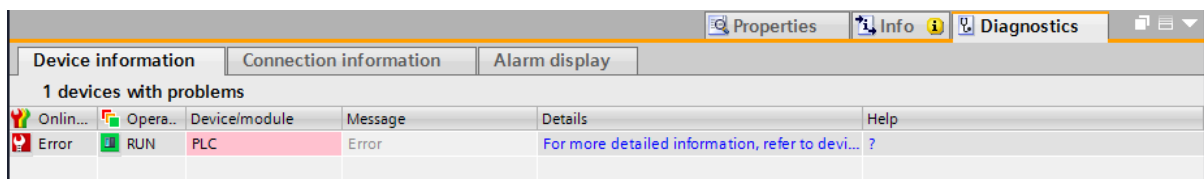

All system and device messages are displayed in the **Diagnostics buffer** window under **Events** and **Details on event**.

2. Select a message in the table, **Display CPU Time Stamps in PG/PC local time**.

Figure 404. Diagnostics Buffer

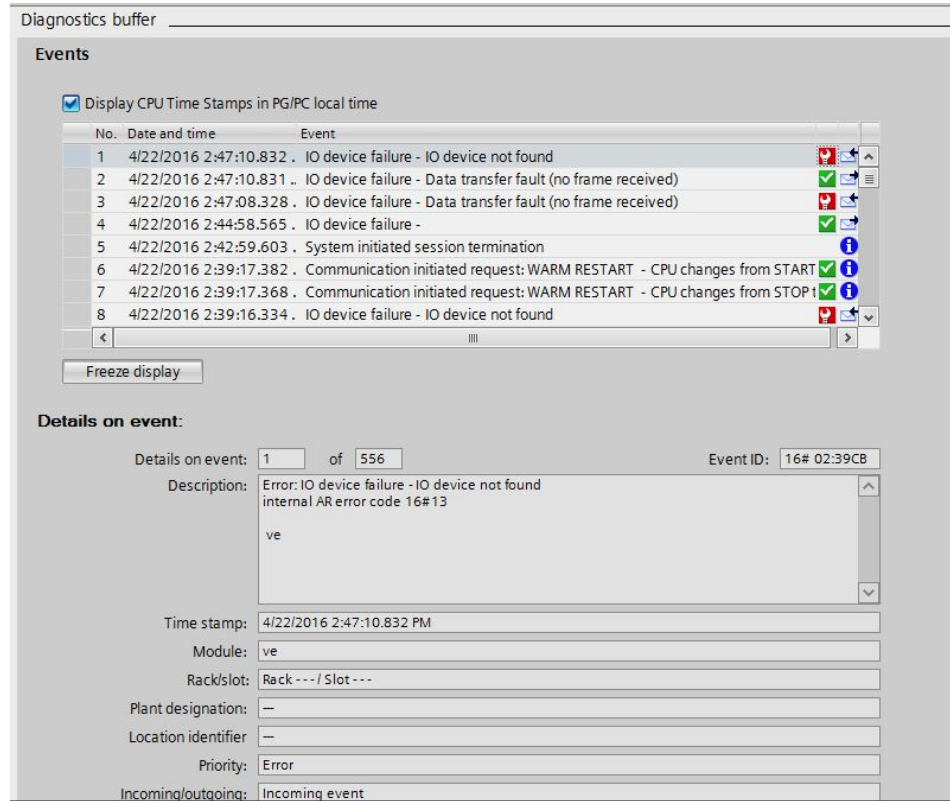

The respective information displays in the **Description** field under **Details on event**.

3. Read the message to learn about the error and resolve it. When the error is resolved, the icon that corresponds to the displayed message is green.

15 Webserver Image Viewing

The webserver automatically refreshes live images from the VE.

Access the images using a URL. The URL is the IP address of the VE followed by `/liveimage.html`. For example, a VE with the IP address 192.168.0.195 has a URL of: `http://192.168.0.195/liveimage.html`

The default resolution of the image using this URL is 640 × 480 pixels, regardless of the native resolution of the VE. The default refresh interval is 1 second, regardless of the total inspection time or the camera trigger rate.

The webserver is also capable of delivering a single (non-refreshing) image file from the URI. For example, a VE with the IP address 192.168.0.195 would deliver a file with the name `192.168.0.195/sensor/liveimage.bmp`.

15.1 Image Size

All images sent from the Webserver are 8-bit grayscale Windows bitmaps (.bmp).

The default size of the images is 640 × 480 pixels. To preserve the aspect ratio of the raw image., a smaller version of the raw camera image is centered in a 640 × 480 frame and black pixels are added around the image as needed.

In the following figure, a WVGA model VE (752 × 480 raw image) has a smaller version of the raw image (represented by the gray box) centered within the 640 × 480 frame. Black pixels are added to both the top and bottom because the height of the raw picture is smaller than the height of the frame. The aspect ratio of the raw VE image is preserved, creating a scaled 640 × 408 raw image inset in the 640 × 480 frame.

Figure 405. WVGA image in 640 × 480 frame



It is possible to access an image larger than 640 × 480 pixels. To do this, use a slightly different URL format that includes the desired width and height and refresh rate within the URL. For example: `http://192.168.0.195/liveimage_w800_h600_r250.html`.

In this format, the “w” and “h” are the desired width and height, in pixels, of the frame, and the “r” is the desired refresh rate, in milliseconds. The maximum frame size is W = 1920 pixels and H = 1080 pixels. The minimum refresh value is 250 milliseconds.

In the following example, a 5 MP model VE has a smaller version of the raw image (represented by the gray box) centered within a custom 800 × 600 frame.

Figure 406. 5 MP image in 800 × 600 frame



Note: This is the custom frame size specified in the example URL, above.

In this case, preserving the 5 MP aspect ratio requires a 759 × 600 raw image to be centered within the 800 × 600 frame.

Reduce the presence of black fill pixels by choosing a frame size proportional to the raw image size of the desired VE. The table below shows the maximum width and height image sizes, based on VE model used.

Resolution	Width, maximum	Height, maximum	Aspect Ratio	Example	
				Width	Height
WVGA	752	480	1.33	500	320
1.3 MP	1280	1024	1.57	500	400
2 MP	1600	1200 ²⁷	1.25	500	376
5 MP	2592 ²⁷	2048 ²⁷	1.27	500	396



Note: To ensure maximum compatibility with all browser and computer types, the width and height values should be divisible by 4.

²⁷ The maximum size image available via the Webserver is 1920 w × 1080 h.

15.2 Images on Example HMIs

On a Human Machine Interface (HMI), the size of the embedded web component should match the URL framed output image size. See the following examples.

Allen-Bradley PanelView Plus 7 Performance Series HMI

On an Allen-Bradley PanelView Plus 7 Performance Series HMI, the web component used to display the image is called *ME Web Browser Control*. When entering the image URL, use double quotes around the URL string.

Figure 407. Example URL with double quotes entered in an Allen-Bradley ME Web Browser Control

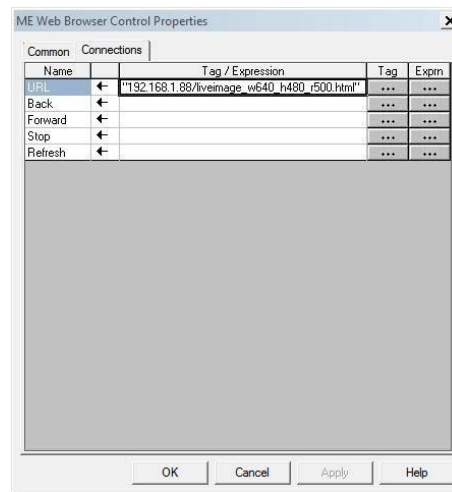

Siemens Simatic TP 1500 HMI

On a Siemens Simatic TP 1500 HMI, the web component used to display the image is called *HTML Browser*. Enter the URL in **Properties > General**, as shown in the following figure.

Figure 408. Example URL in a Siemens TP 1500 HTML Browser

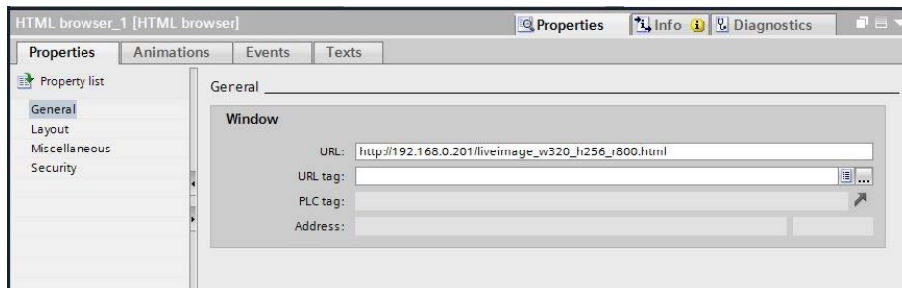

Proface Win GP Windows Runtime HMI

On a Proface Win GP Windows Runtime HMI (SP5000 Series Open Box, PS5000 Series IPC, and General Windows PC), use the **Switch Feature Special Switch** to start an external application and to pass a parameter with the required URL.

Figure 409. GP Pro-EX Software Special Switch part used to Start Application, pointed to web browser with IP address Parameter

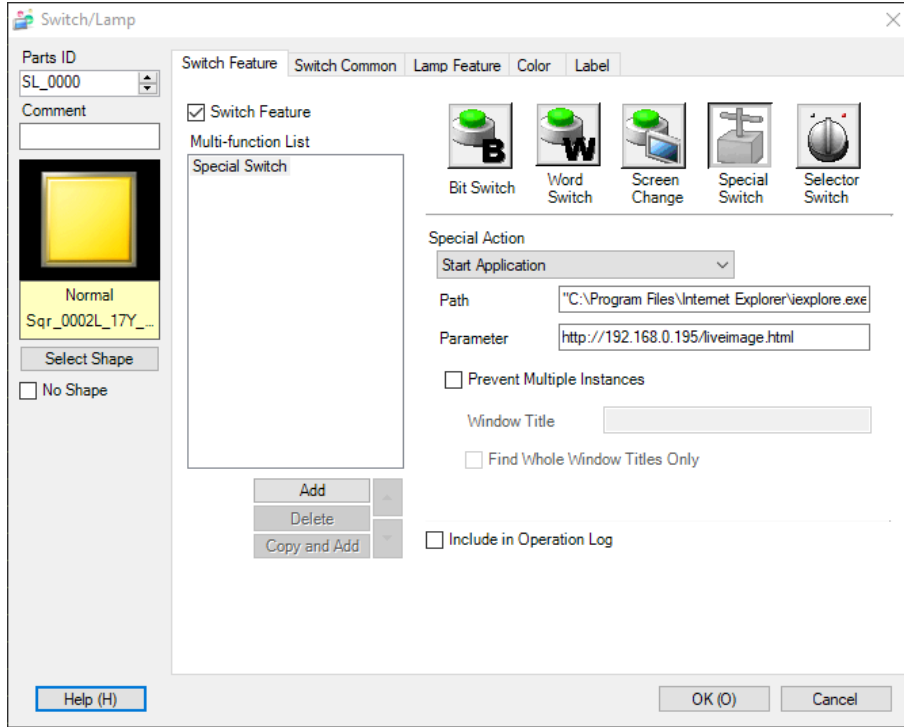

RedLion HMI

On a RedLion HMI, the IP Camera protocol is used to make a connection to the image webserver.

Enter the following information:

- **IP Address**—The IP address of the sensor
- **Port Number**—80
- **Image URI**—The path to the bitmap image component served from the webserver

For display, use a Camera primitive linked to this IP Camera protocol. Make sure the Camera primitive's frame size is equal to or larger than the image requested. Alternatively, you can use the scale options in the Camera primitive properties screen.



Note: Polling for an image more frequently than every 100 ms is not recommended.

Figure 410. RedLion IP Camera protocol selection

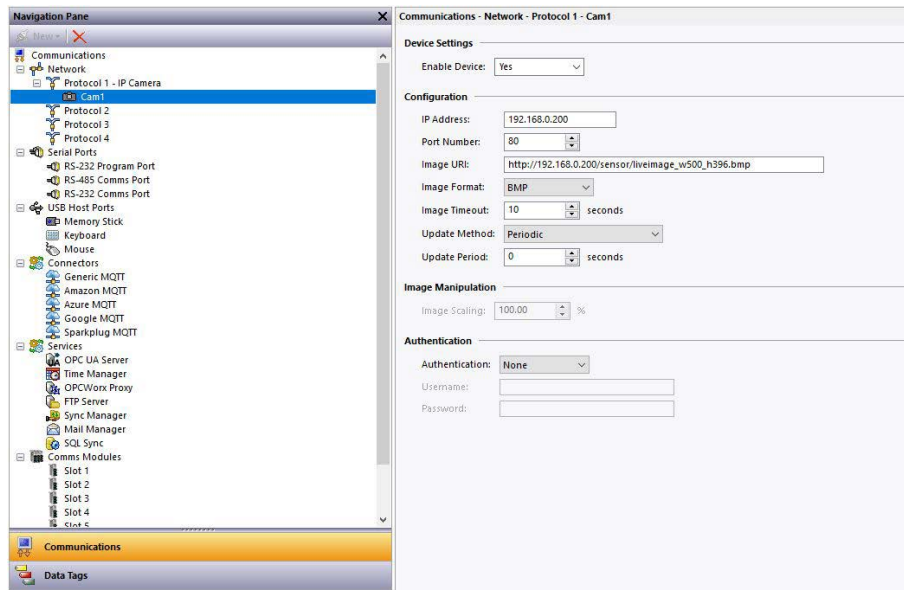

15.3 Images on a Web Browser

When viewed from a desktop PC web browser, the framed output image webpage automatically refreshes.

A VE with the IP address 192.168.0.195 has a URL of: <http://192.168.0.195/liveimage.html>

Figure 411. 5 MP image in 800 × 600 frame (web browser)



The image component (a single, non-refreshing image) can also be accessed via a web browser. For example, a VE with the IP address 192.168.0.195 would deliver a file with the name 192.168.0.195/sensor/liveimage_w500_h396.bmp.

Figure 412. WVGA Image Bitmap (web browser)



16 Troubleshooting

Problem	Solution
The Vision Manager software will not connect to my sensor	Make sure that: <ul style="list-style-type: none"> • The sensor is powered on • The sensor is connected to the computer or the network • You are connecting to the correct sensor (verify the sensor name and IP address)
The image is not clear	Make sure that: <ul style="list-style-type: none"> • The lens is properly screwed onto the sensor • The lens is clean • The lens is properly focused (see Acquire a Good Image on p. 18)
No images appear in the Image pane	Make sure that: <ul style="list-style-type: none"> • The exposure is correct (run Auto Exposure) • The sensor is receiving trigger signals
I changed a test parameter but the test does not seem to be working	Make sure that the test parameter checkbox is selected to enable the test parameter

Depending on the situation, a message may appear on the computer screen. These messages include an identification number, a message description, and a list of recommended solutions. There is also an option to send a report to Banner Engineering.

16.1 Vision Manager Error Codes

Error Code	Description	Recommended Solution
10000	The sensor's feature set is too old to work with this version of Vision Manager.	<ul style="list-style-type: none"> • Update the sensor firmware to a version compatible with this application • Install an older version of this application
10001	The sensor's feature set is too new to work with this version of Vision Manager.	<ul style="list-style-type: none"> • Install an newer version of this application • Downgrade the sensor firmware to a version compatible with this application
10005	The sensor was not found at the specified IP address. Network PING results indicate no device present at the specified IP address.	<ul style="list-style-type: none"> • Verify the sensor is energized • Verify the sensor communication cable is connected • Verify all inline network equipment is energized, properly configured and connected • Verify all required network equipment cables are connected • Verify the network adaptor is properly configured • Verify the sensor IP address is valid • Verify the sensor subnet is valid
10010	A connection to the sensor could not be established. One or more required channels failed to connect.	<ul style="list-style-type: none"> • Verify the sensor is energized • Verify the sensor communication cable is connected • Verify all inline network equipment is energized, properly configured and connected • Verify all required network equipment cables are connected • Verify the network adaptor is properly configured • Verify the sensor IP address is valid • Verify there are no other devices using the same IP address • Verify the sensor subnet is valid • Verify the sensor can be successfully pinged • Verify the network firewall settings support connection to the sensor

Error Code	Description	Recommended Solution
10011	A connection to the sensor could not be established. One or more required channels failed to connect	<ul style="list-style-type: none"> • Verify the sensor is energized • Verify the sensor communication cable is connected • Verify all inline network equipment is energized, properly configured and connected • Verify all required network equipment cables are connected • Verify the network adaptor is properly configured • Verify the sensor IP address is valid • Verify there are no other devices using the same IP address • Verify the sensor subnet is valid • Verify the sensor can be successfully pinged • Verify the network firewall settings support connection to the sensor
10012	A connection to the sensor could not be established. A timeout occurred connecting required channels.	<ul style="list-style-type: none"> • Verify the sensor is energized • Verify the sensor communication cable is connected • Verify all inline network equipment is energized, properly configured and connected • Verify all required network equipment cables are connected • Verify the network adaptor is properly configured • Verify the sensor IP address is valid • Verify there are no other devices using the same IP address • Verify the sensor subnet is valid • Verify the sensor can be successfully pinged • Verify the network firewall settings support connection to the sensor
10020	A connection to the sensor could not be established. One or more required channels failed to connect.	<ul style="list-style-type: none"> • Verify the sensor is energized • Verify the sensor communication cable is connected • Verify all inline network equipment is energized, properly configured and connected • Verify all required network equipment cables are connected • Verify the network adaptor is properly configured • Verify the sensor IP address is valid • Verify there are no other devices using the same IP address • Verify the sensor subnet is valid • Verify the sensor can be successfully pinged • Verify the network firewall settings support connection to the sensor
10021	A connection to the sensor could not be established. One or more required channels failed to connect.	<ul style="list-style-type: none"> • Verify the sensor is energized • Verify the sensor communication cable is connected • Verify all inline network equipment is energized, properly configured and connected • Verify all required network equipment cables are connected • Verify the network adaptor is properly configured • Verify the sensor IP address is valid • Verify there are no other devices using the same IP address • Verify the sensor subnet is valid • Verify the sensor can be successfully pinged • Verify the network firewall settings support connection to the sensor

Error Code	Description	Recommended Solution
10022	The connection to the sensor was lost while sending data.	<ul style="list-style-type: none"> • Verify the sensor is energized • Verify the sensor communication cable is connected • Verify all inline network equipment is energized, properly configured and connected • Verify all required network equipment cables are connected • Verify the network adaptor is properly configured • Verify the sensor IP address is valid • Verify there are no other devices using the same IP address • Verify the sensor subnet is valid • Verify the sensor can be successfully pinged • Verify the network firewall settings support connection to the sensor
10023	The connection to the sensor was lost while receiving data.	<ul style="list-style-type: none"> • Verify the sensor is energized • Verify the sensor communication cable is connected • Verify all inline network equipment is energized, properly configured and connected • Verify all required network equipment cables are connected • Verify the network adaptor is properly configured • Verify the sensor IP address is valid • Verify there are no other devices using the same IP address • Verify the sensor subnet is valid • Verify the sensor can be successfully pinged • Verify the network firewall settings support connection to the sensor
10024	The connection to the sensor was lost while receiving data.	<ul style="list-style-type: none"> • Verify the sensor is energized • Verify the sensor communication cable is connected • Verify all inline network equipment is energized, properly configured and connected • Verify all required network equipment cables are connected • Verify the network adaptor is properly configured • Verify the sensor IP address is valid • Verify there are no other devices using the same IP address • Verify the sensor subnet is valid • Verify the sensor can be successfully pinged • Verify the network firewall settings support connection to the sensor
10025	The connection to the sensor was lost while receiving data.	<ul style="list-style-type: none"> • Verify the sensor is energized • Verify the sensor communication cable is connected • Verify all inline network equipment is energized, properly configured and connected • Verify all required network equipment cables are connected • Verify the network adaptor is properly configured • Verify the sensor IP address is valid • Verify there are no other devices using the same IP address • Verify the sensor subnet is valid • Verify the sensor can be successfully pinged • Verify the network firewall settings support connection to the sensor

Error Code	Description	Recommended Solution
10026	The connection to the sensor was lost while receiving data.	<ul style="list-style-type: none"> • Verify the sensor is energized • Verify the sensor communication cable is connected • Verify all inline network equipment is energized, properly configured and connected • Verify all required network equipment cables are connected • Verify the network adaptor is properly configured • Verify the sensor IP address is valid • Verify there are no other devices using the same IP address • Verify the sensor subnet is valid • Verify the sensor can be successfully pinged • Verify the network firewall settings support connection to the sensor
10027	The connection to the sensor was lost.	<ul style="list-style-type: none"> • Verify the sensor is energized • Verify the sensor communication cable is connected • Verify all inline network equipment is energized, properly configured and connected • Verify all required network equipment cables are connected • Verify the network adaptor is properly configured • Verify the sensor IP address is valid • Verify there are no other devices using the same IP address • Verify the sensor subnet is valid • Verify the sensor can be successfully pinged • Verify the network firewall settings support connection to the sensor
10040	The device at the specified IP address is already connected to another application. This can happen when another Vision Manager is already connected to the sensor.	<ul style="list-style-type: none"> • Disconnect the other application and try again • Verify there are no other devices using the same IP address
10041	The device at the specified IP address rejected the connection attempt. This can happen when the network device does not support the Vision Manager protocol.	<ul style="list-style-type: none"> • Verify the sensor's firmware version is compatible with this application • Verify the device at the specified IP address is a Banner Vision sensor
10050	The connection to the sensor was lost.	<ul style="list-style-type: none"> • Verify the sensor is energized • Verify the sensor communication cable is connected • Verify all inline network equipment is energized, properly configured and connected • Verify all required network equipment cables are connected • Verify the network adaptor is properly configured • Verify the sensor IP address is valid • Verify there are no other devices using the same IP address • Verify the sensor subnet is valid • Verify the sensor can be successfully pinged • Verify the network firewall settings support connection to the sensor
10051	The connection to the sensor was lost.	<ul style="list-style-type: none"> • Verify the sensor is energized • Verify the sensor communication cable is connected • Verify all inline network equipment is energized, properly configured and connected • Verify all required network equipment cables are connected • Verify the network adaptor is properly configured • Verify the sensor IP address is valid • Verify there are no other devices using the same IP address • Verify the sensor subnet is valid • Verify the sensor can be successfully pinged • Verify the network firewall settings support connection to the sensor

Error Code	Description	Recommended Solution
10053	The connection to the sensor was lost while receiving data.	<ul style="list-style-type: none"> • Verify the sensor is energized • Verify the sensor communication cable is connected • Verify all inline network equipment is energized, properly configured and connected • Verify all required network equipment cables are connected • Verify the network adaptor is properly configured • Verify the sensor IP address is valid • Verify there are no other devices using the same IP address • Verify the sensor subnet is valid • Verify the sensor can be successfully pinged • Verify the network firewall settings support connection to the sensor
10054	The Connection to the sensor was lost while receiving data.	<ul style="list-style-type: none"> • Verify the sensor is energized • Verify the sensor communication cable is connected • Verify all inline network equipment is energized, properly configured and connected • Verify all required network equipment cables are connected • Verify the network adaptor is properly configured • Verify the sensor IP address is valid • Verify there are no other devices using the same IP address • Verify the sensor subnet is valid • Verify the sensor can be successfully pinged • Verify the network firewall settings support connection to the sensor
10055	The Connection to the sensor was lost due to network keep alive expiration.	<ul style="list-style-type: none"> • Verify the network adaptor link speed and duplex settings • Verify the is sensor not stalled, or in shutdown mode
10070	The Connection to sensor was lost due to a receive state machine error.	<ul style="list-style-type: none"> • Verify the is sensor not stalled, or in shutdown mode • Verify the sensor is supported by this version
10071	The Connection to sensor was lost due to a receive state machine error.	<ul style="list-style-type: none"> • Verify the is sensor not stalled, or in shutdown mode • Verify the sensor is supported by this version
10080	The Connection to sensor was lost.	<ul style="list-style-type: none"> • Verify the sensor is energized • Verify the sensor communication cable is connected • Verify all inline network equipment is energized, properly configured and connected • Verify all required network equipment cables are connected • Verify the network adaptor is properly configured • Verify the sensor IP address is valid • Verify there are no other devices using the same IP address • Verify the sensor subnet is valid • Verify the sensor can be successfully pinged • Verify the network firewall settings support connection to the sensor
10085	A connection to the sensor could not be established. One or more required channels failed to connect.	<ul style="list-style-type: none"> • Verify the sensor is energized • Verify the sensor communication cable is connected • Verify all inline network equipment is energized, properly configured and connected • Verify all required network equipment cables are connected • Verify the network adaptor is properly configured • Verify the sensor IP address is valid • Verify there are no other devices using the same IP address • Verify the sensor subnet is valid • Verify the sensor can be successfully pinged • Verify the network firewall settings support connection to the sensor

Error Code	Description	Recommended Solution
10086	The connection to the sensor was lost while receiving data.	<ul style="list-style-type: none"> • Verify the sensor is energized • Verify the sensor communication cable is connected • Verify all inline network equipment is energized, properly configured and connected • Verify all required network equipment cables are connected • Verify the network adaptor is properly configured • Verify the sensor IP address is valid • Verify there are no other devices using the same IP address • Verify the sensor subnet is valid • Verify the sensor can be successfully pinged • Verify the network firewall settings support connection to the sensor
10091	Receiving data from the sensor timed out (no data was received). The connection to the sensor was aborted by this application.	<ul style="list-style-type: none"> • Verify the network adaptor link speed and duplex settings • Verify the is sensor not stalled, or in shutdown mode
10092	Receiving data from the sensor timed out (partial data was received). The connection to the sensor was aborted by this application.	<ul style="list-style-type: none"> • Verify the network adaptor link speed and duplex settings • Verify the is sensor not stalled, or in shutdown mode
10093	A parsing error was detected while receiving data from the sensor. The connection to the sensor was aborted by this application.	<ul style="list-style-type: none"> • Verify the network adaptor link speed and duplex settings • Verify the is sensor not stalled, or in shutdown mode
10094	A receive overrun was detected while receiving data from the sensor. The connection to the sensor was aborted by this application.	<ul style="list-style-type: none"> • Verify the network adaptor link speed and duplex settings • Verify the is sensor not stalled, or in shutdown mode
10095	Receiving data from the sensor timed out (internal error). The connection to the sensor was aborted by this application.	<ul style="list-style-type: none"> • Verify the network adaptor link speed and duplex settings • Verify the is sensor not stalled, or in shutdown mode
10096	A transmit timeout occurred while sending data to the sensor (no data was sent). The connection to the sensor was aborted by this application.	<ul style="list-style-type: none"> • Verify the network adaptor link speed and duplex settings • Verify the is sensor not stalled, or in shutdown mode
10097	A transmit timeout occurred while sending data to the sensor (partial data was sent). The connection to the sensor was aborted by this application.	<ul style="list-style-type: none"> • Verify the network adaptor link speed and duplex settings • Verify the is sensor not stalled, or in shutdown mode
10100	The connection to the sensor was lost while sending data.	<ul style="list-style-type: none"> • Install an newer version of this application • Verify the device at the specified IP address is a Banner Vision sensor • Verify the sensor's firmware version is compatible with this application • Check the firewall setup on computer • Go to Sensor Neighborhood and reconnect to the sensor
10101	The connection to the sensor was lost while sending data.	<ul style="list-style-type: none"> • Install an newer version of this application • Verify the device at the specified IP address is a Banner Vision sensor • Verify the sensor's firmware version is compatible with this application • Check the firewall setup on computer • Go to Sensor Neighborhood and reconnect to the sensor

Error Code	Description	Recommended Solution
10110	The connection to the sensor was aborted by this application due to an internal processing error.	<ul style="list-style-type: none"> • Install an newer version of this application • Verify the device at the specified IP address is a Banner Vision sensor • Verify the sensor's firmware version is compatible with this application • Check the firewall setup on computer • Go to Sensor Neighborhood and reconnect to the sensor
10111	The connection to the sensor was aborted by this application due to an internal processing error.	<ul style="list-style-type: none"> • Install an newer version of this application • Verify the device at the specified IP address is a Banner Vision sensor • Verify the sensor's firmware version is compatible with this application • Check the firewall setup on computer • Go to Sensor Neighborhood and reconnect to the sensor
10120	The connection to the sensor was aborted by this application due to an internal processing error.	<ul style="list-style-type: none"> • Install an newer version of this application • Verify the device at the specified IP address is a Banner Vision sensor • Verify the sensor's firmware version is compatible with this application • Check the firewall setup on computer • Go to Sensor Neighborhood and reconnect to the sensor
10125	The connection to the sensor was aborted by this application due to an internal processing error.	<ul style="list-style-type: none"> • Install an newer version of this application • Verify the device at the specified IP address is a Banner Vision sensor • Verify the sensor's firmware version is compatible with this application • Check the firewall setup on computer • Go to Sensor Neighborhood and reconnect to the sensor
10126	The connection to the sensor was aborted by this application due to an internal processing error.	<ul style="list-style-type: none"> • Install an newer version of this application • Verify the device at the specified IP address is a Banner Vision sensor • Verify the sensor's firmware version is compatible with this application • Check the firewall setup on computer • Go to Sensor Neighborhood and reconnect to the sensor
10140	The Connection to the sensor was lost due to network keep alive expiration.	<ul style="list-style-type: none"> • Install an newer version of this application • Verify the device at the specified IP address is a Banner Vision sensor • Verify the sensor's firmware version is compatible with this application • Check the firewall setup on computer • Go to Sensor Neighborhood and reconnect to the sensor
10150	The connection to the sensor was aborted by this application due to an internal processing error.	<ul style="list-style-type: none"> • Install an newer version of this application • Verify the device at the specified IP address is a Banner Vision sensor • Verify the sensor's firmware version is compatible with this application • Check the firewall setup on computer • Go to Sensor Neighborhood and reconnect to the sensor
10190	The connection to the sensor was aborted by this application due to an internal threading error.	<ul style="list-style-type: none"> • Install an newer version of this application • Verify the device at the specified IP address is a Banner Vision sensor • Verify the sensor's firmware version is compatible with this application • Check the firewall setup on computer • Go to Sensor Neighborhood and reconnect to the sensor

Error Code	Description	Recommended Solution
10300	Vision Manager and the sensor's release types must exactly match. Release types are specified as part of the version (e.g. ALPHA, BETA, EVAL). The connection was aborted by this application.	<ul style="list-style-type: none"> • Install the version of this application which matches the release of the sensor • Update the sensor firmware to match the release type of this application
10900	The file selected for firmware update is not valid for use with this application.	<ul style="list-style-type: none"> • Select a firmware update file which is supported by this application
10910	The file selected for firmware update is too old to work with this application.	<ul style="list-style-type: none"> • Install an older version of this application
10911	The file selected for firmware update is too new to work with this application.	<ul style="list-style-type: none"> • Install an newer version of this application
10912	The firmware update process timed out.	<ul style="list-style-type: none"> • Verify the sensor is energized • Verify the is sensor not stalled, or in shutdown mode • Reboot the sensor
20000	An application error occurred while refreshing the display. An unhandled exception was detected.	<ul style="list-style-type: none"> • Go to Sensor Neighborhood and reconnect to the sensor
20001	An application error occurred while refreshing the display. There was a problem parsing data from the sensor.	<ul style="list-style-type: none"> • Go to Sensor Neighborhood and reconnect to the sensor
20010	An application error occurred while refreshing the display. There was a problem creating screen elements.	<ul style="list-style-type: none"> • Go to Sensor Neighborhood and reconnect to the sensor
20011	An application error occurred while refreshing the display. There was a problem releasing screen elements.	<ul style="list-style-type: none"> • Go to Sensor Neighborhood and reconnect to the sensor
20020	An application error occurred while refreshing the display. There was a problem synchronizing data.	<ul style="list-style-type: none"> • Go to Sensor Neighborhood and reconnect to the sensor
20021	An application error occurred while refreshing the display. There was a problem releasing data resources.	<ul style="list-style-type: none"> • Go to Sensor Neighborhood and reconnect to the sensor
20030	An application error occurred while refreshing the display. There was a problem synchronizing with the inspection.	<ul style="list-style-type: none"> • Go to Sensor Neighborhood and reconnect to the sensor
20040	An application error occurred while refreshing the display. There was a problem updating input data.	<ul style="list-style-type: none"> • Go to Sensor Neighborhood and reconnect to the sensor
20041	An application error occurred while refreshing the display. There was a problem updating result data.	<ul style="list-style-type: none"> • Go to Sensor Neighborhood and reconnect to the sensor
20050	This application detected an error while refreshing the display. There was a problem rendering the image.	<ul style="list-style-type: none"> • Go to Sensor Neighborhood and reconnect to the sensor
20060	An application error occurred while refreshing the display. There was a problem updating pixel annotations.	<ul style="list-style-type: none"> • Go to Sensor Neighborhood and reconnect to the sensor

Error Code	Description	Recommended Solution
20061	An application error occurred while refreshing the display. There was a problem updating pixel annotations.	<ul style="list-style-type: none"> Go to Sensor Neighborhood and reconnect to the sensor
20070	An application error occurred while refreshing the display. There was a problem updating vector annotations.	<ul style="list-style-type: none"> Go to Sensor Neighborhood and reconnect to the sensor
20071	An application error occurred while refreshing the display. There was a problem updating vector annotations.	<ul style="list-style-type: none"> Go to Sensor Neighborhood and reconnect to the sensor
20072	An application error occurred while refreshing the display. There was a problem releasing vector annotations.	<ul style="list-style-type: none"> Go to Sensor Neighborhood and reconnect to the sensor
20073	An application error occurred while refreshing the display. There was a problem releasing display elements.	<ul style="list-style-type: none"> Go to Sensor Neighborhood and reconnect to the sensor
20100	There was a problem using the specified file.	<ul style="list-style-type: none"> Verify the user has access to the file
20101	An invalid file format was detected.	<ul style="list-style-type: none"> Verify the selected file is compatible with this application
20103	The maximum number of tools has been added to the device.	<ul style="list-style-type: none"> Remove some tools from the device
20104	There was a problem restoring the selected file to the sensor.	<ul style="list-style-type: none"> Call Banner Customer Support
20105	There was a problem creating the backup of the sensor.	<ul style="list-style-type: none"> Call Banner Customer Support
20130	There was a problem viewing the selected inspection log.	<ul style="list-style-type: none"> Install an newer version of this application
20150	Connection to the emulator failed.	<ul style="list-style-type: none"> Call Banner Customer Support
20151	There was an error starting the emulator.	<ul style="list-style-type: none"> Reinstall this application Check the firewall setup on computer
20152	The selected emulator could not be found.	<ul style="list-style-type: none"> Reinstall this application Check the firewall setup on computer
20153	There was a problem closing the previous emulator session.	<ul style="list-style-type: none"> Reboot the computer to end any processes which did not shut down properly
20154	There was a problem closing the previous emulator session.	<ul style="list-style-type: none"> Reboot the computer to end any processes which did not shut down properly
20155	There was a problem closing the previous emulator session.	<ul style="list-style-type: none"> Reboot the computer to end any processes which did not shut down properly
20156	There was a problem closing the previous emulator session.	<ul style="list-style-type: none"> Reboot the computer to end any processes which did not shut down properly
20157	There was an error starting the emulator.	<ul style="list-style-type: none"> Reinstall this application Check the firewall setup on computer
20158	There was an error starting the emulator.	<ul style="list-style-type: none"> Reinstall this application Check the firewall setup on computer
20159	There was an error starting the emulator.	<ul style="list-style-type: none"> Reinstall this application Check the firewall setup on computer

Error Code	Description	Recommended Solution
20160	Another emulator session is currently running. Only one emulator session can be run at a time.	<ul style="list-style-type: none"> • Close the other Vision Manager currently connected to the emulator • Reboot the computer to end any processes which did not shut down properly
20203	Uploading the image to the sensor failed due to timeout.	<ul style="list-style-type: none"> • Reboot the sensor • Verify the sensor communication cable is connected • Verify all inline network equipment is energized, properly configured and connected • Verify all required network equipment cables are connected • Verify the network adaptor is properly configured • Verify the sensor IP address is valid • Verify there are no other devices using the same IP address • Verify the sensor subnet is valid • Verify the sensor can be successfully pinged • Verify the network firewall settings support connection to the sensor
20208	Downloading the inspection from the sensor failed due to a timeout.	<ul style="list-style-type: none"> • Reboot the sensor • Verify the sensor communication cable is connected • Verify all inline network equipment is energized, properly configured and connected • Verify all required network equipment cables are connected • Verify the network adaptor is properly configured • Verify the sensor IP address is valid • Verify there are no other devices using the same IP address • Verify the sensor subnet is valid • Verify the sensor can be successfully pinged • Verify the network firewall settings support connection to the sensor
20209	Inspection download invalid parameter.	<ul style="list-style-type: none"> • Go to Sensor Neighborhood and reconnect to the sensor • Reboot the sensor • Update the sensor firmware to the latest version • Update the Vision Manager Application to the latest version
20210	Downloading the inspection from the sensor failed (inspection not found).	<ul style="list-style-type: none"> • Go to Sensor Neighborhood and reconnect to the sensor • Reboot the sensor • Update the sensor firmware to the latest version • Update the Vision Manager Application to the latest version
20211	Downloading the inspection from the sensor failed (invalid header detected).	<ul style="list-style-type: none"> • Go to Sensor Neighborhood and reconnect to the sensor • Reboot the sensor • Update the sensor firmware to the latest version • Update the Vision Manager Application to the latest version
20212	Downloading the inspection from the sensor failed (incompatibility detected).	<ul style="list-style-type: none"> • Go to Sensor Neighborhood and reconnect to the sensor • Reboot the sensor • Update the sensor firmware to the latest version • Update the Vision Manager Application to the latest version
20215	Uploading the inspection to the sensor failed due to a timeout.	<ul style="list-style-type: none"> • Reboot the sensor • Verify the sensor communication cable is connected • Verify all inline network equipment is energized, properly configured and connected • Verify all required network equipment cables are connected • Verify the network adaptor is properly configured • Verify the sensor IP address is valid • Verify there are no other devices using the same IP address • Verify the sensor subnet is valid • Verify the sensor can be successfully pinged • Verify the network firewall settings support connection to the sensor

Error Code	Description	Recommended Solution
20216	Uploading the inspection to the sensor failed due to an invalid parameter.	<ul style="list-style-type: none"> Go to Sensor Neighborhood and reconnect to the sensor Reboot the sensor Update the sensor firmware to the latest version Update the Vision Manager Application to the latest version
20219	Upload inspection to sensor failed. The inspection being uploaded contains features which are not compatible with the sensor.	<ul style="list-style-type: none"> Update the sensor firmware to the latest version Update the Vision Manager Application to the latest version
20231	A firmware update error was detected.	<ul style="list-style-type: none"> Verify the sensor is energized Verify the is sensor not stalled, or in shutdown mode Reboot the sensor Verify the sensor communication cable is connected Verify all inline network equipment is energized, properly configured and connected Verify all required network equipment cables are connected Verify the network adaptor is properly configured Verify the sensor IP address is valid Verify there are no other devices using the same IP address Verify the sensor subnet is valid Verify the sensor can be successfully pinged Verify the network firewall settings support connection to the sensor
20232	A firmware update timeout was detected.	<ul style="list-style-type: none"> Reboot the sensor Verify the sensor communication cable is connected Verify all inline network equipment is energized, properly configured and connected Verify all required network equipment cables are connected Verify the network adaptor is properly configured Verify the sensor IP address is valid Verify there are no other devices using the same IP address Verify the sensor subnet is valid Verify the sensor can be successfully pinged Verify the network firewall settings support connection to the sensor
20233	A maintenance service internal error was detected.	<ul style="list-style-type: none"> Go to Sensor Neighborhood and reconnect to the sensor Reboot the sensor Update the sensor firmware to the latest version Update the Vision Manager Application to the latest version
20400	An application error occurred while applying the new industrial protocol settings. The settings will be reverted to their previous value.	<ul style="list-style-type: none"> Update the sensor firmware to the latest version Update the Vision Manager Application to the latest version
20500	An application error occurred while applying the new data export settings. The settings will be reverted to their previous value.	<ul style="list-style-type: none"> Call Banner Customer Support
20600	An application error occurred while applying the new user profile settings. The settings will be reverted to their previous value.	<ul style="list-style-type: none"> Call Banner Customer Support
30151	Firmware update cannot proceed. Selected sensor may be connected to another Vision Manager application	<ul style="list-style-type: none"> Disconnect the other application and try again
30152	Firmware update cannot be completed due to internal error.	<ul style="list-style-type: none"> Reboot the sensor

Error Code	Description	Recommended Solution
30153	Firmware update cannot be completed due to internal error.	<ul style="list-style-type: none"> Reboot the sensor
30154	Firmware update cannot be completed due to internal error.	<ul style="list-style-type: none"> Reboot the sensor
30155	Firmware update cannot be completed due to internal error.	<ul style="list-style-type: none"> Reboot the sensor
30156	Firmware update cannot be completed due to internal error.	<ul style="list-style-type: none"> Reboot the sensor
30157	Firmware update cannot be completed due to internal error.	<ul style="list-style-type: none"> Reboot the sensor
30199	Firmware update cannot be completed due to internal error.	<ul style="list-style-type: none"> Call Banner Customer Support

16.2 VE Error and Warning Codes

ID	Description	Recommended Solution
1 - 999	Internal System Error	<ul style="list-style-type: none"> Clear the error using Vision Manager or Industrial Ethernet If the error occurs repeatedly, contact Banner Engineering
1008	Inspection at selected slot contains unsupported settings.	Delete the inspection and recreate it using current firmware or emulator
1009	Inspection marked as Startup Inspection could not be loaded at bootup.	A new inspection will be created with default settings
1100	Inspection was created with Scaled Units enabled. Inspection modified as Scaled Units feature is currently disabled.	Review the inspection parameter settings. If this behavior is not desired, verify that the Scaled Units settings are set as required by the inspection.
1101	Inspection was created with Scaled Units disabled. Inspection modified as Scaled Units feature is currently enabled.	Review the inspection parameter settings. If this behavior is not desired, verify that the Scaled Units settings are set as required by the inspection.
1102	Inspection was created with different Scaled Units settings. Inspection modified to match current Scaled Units settings.	Review the inspection parameter settings. If this behavior is not desired, verify that the Scaled Units settings are set as required by the inspection.
1103	Current inspection settings modified to match current firmware version.	Review the inspection parameter settings
1104	Inspection was created using features which are incompatible with current firmware and is not allowed to be loaded.	Recreate this inspection with the current firmware version
1111	Formatted inspection results exceed the maximum output size.	The data included for export exceeds capacity of this channel. Remove some items to export.
1112	Data export timed out.	<ul style="list-style-type: none"> Verify that the receiving application is running and connected Verify that the network bandwidth is sufficient to transmit the data
1113	Image export timed out.	<ul style="list-style-type: none"> Verify that the receiving application is running and connected Verify that the network bandwidth is sufficient to transmit the data

ID	Description	Recommended Solution
1200-1290	Device boot error.	<ul style="list-style-type: none"> • Check that the power to device is within recommended levels and is stable • Check that the device is properly grounded as recommended in the Instruction Manual • Verify that electric static noise around the device does not exceed CE specifications • If the error still persists, contact Banner Engineering

16.3 TCP and UDP Port Numbers

The following TCP and UDP ports are used for full communication between the VE sensor and the control system (PC, PLC, HMI, etc.).

If firewall or antivirus software is interfering with the use of the VE sensor, use this information to modify the firewall or antivirus settings.

Port Number	Protocol	Description
0-1024	TCP+UDP	Telnet, FTP, HTTP, etc.
502	TCP+UDP	ModbusTCP
2222	UDP	EtherNet/IP IO
19995	UDP	Sensor Discovery
32000	TCP	Command Channel default port ²⁸
32100	TCP	Data Export default port ²⁸
32200	TCP	Image Export default port ²⁸
38510-38534	TCP	Sensor to GUI communication
38536-38539	UDP	Discovery Ports
34962-38964	TCP+UDP	PROFINET
44818	TCP	EtherNet/IP UCMM
49162	TCP+UDP	PROFINET

²⁸ These are the default port numbers, however they can be changed in the Vision Manager software. They cannot be changed to any port number that is already in use.

17 Accessories

17.1 Cordsets

All measurements are listed in millimeters [inches], unless noted otherwise.

Power, Discrete I/O Cordsets

I/O sealed high-flex cordsets, 12 flying leads

12-Pin M12/Euro-Style Cordsets with Open Shield				
Model	Length	Style	Dimensions	Pinout (Female)
MQDC2S-1206	2 m (6.56 ft)	Straight		<ul style="list-style-type: none"> 1 = White 2 = Brown 3 = Green 4 = Yellow 5 = Gray 6 = Pink 7 = Blue 8 = Red 9 = Orange 10 = Light Blue 11 = Black 12 = Violet
MQDC2S-1215	5 m (16.40 ft)			
MQDC2S-1230	9 m (29.53 ft)			
MQDC2S-1250	16 m (52.49 ft)			
MQDC2S-1275	23 m (75.46 ft)			
MQDC2S-1206RA	2 m (6.56 ft)	Right Angle		
MQDC2S-1215RA	5 m (16.40 ft)			
MQDC2S-1230RA	9 m (29.53 ft)			
MQDC2S-1250RA	16 m (52.49 ft)			

Ethernet Cordsets

RJ45 Ethernet to 8-Pin Threaded M12/Euro-Style Cordsets				
Model	Length	Style	Dimensions	Pinout
STP-M12-806	1.83 m (6 ft)	Straight, Cat5e Shielded		<ul style="list-style-type: none"> 1 = White/Black 2 = White/Brown 3 = Brown 4 = Orange 5 = White/Green 6 = White/Orange 7 = Blue 8 = Green
STP-M12-815	4.57 m (15 ft)			
STP-M12-830	9.14 m (30 ft)			

The following Ethernet cables are used with 4-pin D-code Ethernet models only.

Model	Description
BWA-E2M	Ethernet cable, RSCD RJ45 440, 2 m (6.6 ft)
BWA-E8M	Ethernet cable, RSCD RJ45 440, 8 m (26.2 ft)

17.2 Brackets

All measurements are listed in millimeters [inches], unless noted otherwise.

SMBVERA

- Right-angle mounting bracket with curved slots
- 12-gauge stainless steel
- M3 × 0.5 mounting hardware included

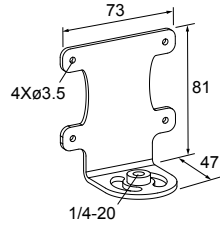

SMBVEMP

- Painted black aluminum
- Adapter holes for mounting hardware

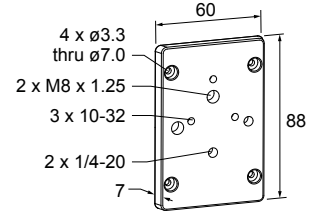

17.3 Lenses

Additional models are available. See www.bannerengineering.com.

Table 35: C-Mount Megapixel Lens Focal Length—For use with WVGA, 1.3MP, or 2MP models

Manufacturer	5 mm	6 mm	8 mm	12 mm	16 mm	25 mm	35 mm	50 mm	75 mm
Computar	LCF05LCMP ²⁹	-	LCF08LMP	LCF12LMP	LCF16LCMP	LCF25LCMP	LCF35LCMP	LCF50LCMP	LCF75LCMP
Evetar	-	LCF06LEVMP ²⁹	LCF08LEVMP	LCF12LEVMP ²⁹	LCF16LEVMP	LCF25LEVMP	LCF35LEVMP	LCF50LEVMP ²⁹	LCF75LEVMP ²⁹

Table 36: C-Mount 1-Inch Format Lens—For use with 5MP models only

Manufacturer	6 mm	8 mm	12 mm	16 mm	25 mm	35 mm	50 mm	75 mm
Kowa	LCF06LK1F ³⁰	LCF08LK1F ³⁰	LCF12LK1F	LCF16LK1F	LCF25LK1F	LCF35LK1F	LCF50LK1F ³¹	LCF75LK1F ³¹

17.3.1 WVGA Lens Working Distance and Field of View

For use with VE200G1A models.

Table 37: C-Mount Standard Lens Focal Length—Working Distance and Field of View

	4 mm ³²	8 mm	12 mm	16 mm
WD (mm)	Approximate Horizontal × Vertical Field of View (FOV) in mm			
150	162 × 103	71 × 45	46 × 29	32 × 20
600	656 × 419	303 × 193	198 × 126	141 × 90
1500	1646 × 1050	767 × 489	500 × 319	360 × 230
FOV (mm)	Approximate Working Distance (WD) in mm			
100 × 64	94	206	310	430
300 × 192	276	594	905	1253
600 × 384	549	1177	1798	2488

Figure 413. Working Distance and Field of View

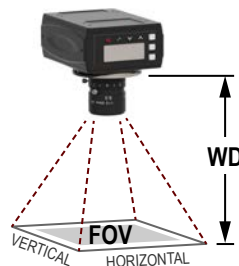

²⁹ For 2 MP lenses only: Denotes specific lens used for WD and FOV example.

³⁰ Not compatible with the sealed lens cover.

³¹ Not compatible with 60 mm sealed lens cover. Use with 85 mm sealed lens cover. Requires LHWK-1 setscrew accessory packet.

³² Using a 0.25 mm spacer (LEKS).

17.3.2 1.3 MP Lens Working Distance and Field of View

For use with VE201G1A models.

Table 38: C-Mount Megapixel Lens Focal Length—Working Distance and Field of View

	6 mm	8 mm	12 mm	16 mm	25 mm	35 mm	50 mm	75 mm
WD (mm)	Approximate Horizontal × Vertical Field of View (FOV) in mm							
150	130 × 104	100 × 80	66 × 53	-	-	-	-	-
600	629 × 503	469 × 375	318 × 254	229 × 183	147 × 118	111 × 89	71 × 57	-
1500	1628 × 1302	1207 × 966	822 × 658	598 × 478	381 × 305	289 × 231	191 × 153	124 × 99
FOV (mm)	Approximate Working Distance (WD) in mm							
100 × 80	123	151	211	286	420	547	820	1227
300 × 240	303	395	569	774	1189	1557	2312	3474
600 × 480	574	760	1104	1505	2343	3072	4551	6845

Figure 414. Working Distance and Field of View

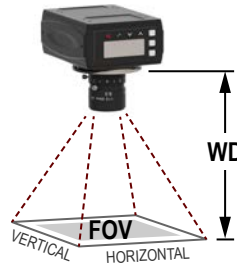

17.3.3 2 MP Lens Working Distance and Field of View

For use with VE202G1A and VE202G2A models.

Table 39: C-Mount Megapixel Lens Focal Length—Working Distance and Field of View

	5 mm	6 mm	8 mm	12 mm	16 mm	25 mm	35 mm	50 mm	75 mm
WD (mm)	Approximate Horizontal × Vertical Field of View (FOV) in mm								
150	188 × 141	140 × 105	126 × 95	72 × 54	55 × 41	36 × 27	-	-	-
600	822 × 617	663 × 498	549 × 411	340 × 255	259 × 194	164 × 123	114 × 86	75 × 56	47 × 35
1500	2091 × 1568	1710 × 1283	1393 × 1045	874 × 656	667 × 500	422 × 317	300 × 225	205 × 154	132 × 99
FOV (mm)	Approximate Working Distance (WD) in mm								
100 × 75	88	-	122	196	248	376	531	774	1160
300 × 225	229	288	335	533	690	1074	1500	2161	3263
600 × 450	442	545	655	1038	1353	2120	2950	4241	6417

Figure 415. Working Distance and Field of View

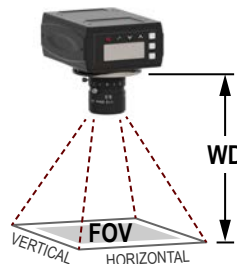

17.3.4 5 MP Lens Working Distance and Field of View

For use with VE205G1A models.

Table 40: C-Mount Megapixel Lens Focal Length—Working Distance and Field of View

	6 mm	8 mm	12.5 mm	16 mm	25 mm	35 mm	50 mm	75 mm
WD (mm)	Approximate Horizontal × Vertical Field of View (FOV) in mm							
300	565 × 446	415 × 328	265 × 209	211 × 167	138 × 109	93 × 73	-	-
600	1212 × 957	887 × 701	566 × 447	445 × 352	289 × 228	200 × 158	130 × 103	-
1500	3154 × 2492	2305 × 1821	1469 × 1161	1147 × 906	742 × 586	521 × 412	352 × 278	233 × 184
FOV (mm)	Approximate Working Distance (WD) in mm							
200 × 158	-	164	235	286	424	600	884	1299
400 × 316	224	291	434	543	821	1160	1697	2511
800 × 632	409	545	833	1056	1614	2282	3322	4935

Figure 416. Working Distance and Field of View

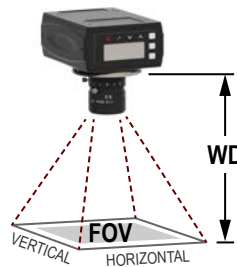

17.4 C-Mount Lens Filter Models

Use filters to improve the image contrast and system reliability in vision applications.

For additional filter information, see p/n 173239.

Family	Color	-	Size
FLT	B470 (Blue) G525 (Green) I850 (Infrared) R635 (Red) R660 (Dark Red) PR032 (Linear Polarizer)	- (dash)	25.5 (25.5 mm) 27 (27 mm) 30.5 (30.5 mm) 34 (34 mm) 35.5 (35.5 mm) 43 (43 mm) 46 (46 mm) 55 (55 mm)

Filters are available in six sizes, specific to the inside thread diameter of the lens. Use the table below to select the corresponding filter for these common C-mount lens types.

Size	Lens Option
25.5 mm	Edmund Optics, Tamron
27 mm	Ricoh, Evetar (8 mm, 12 mm, 16 mm, 25 mm, 35 mm)
30.5 mm	Computar (8 mm, 12 mm, 16 mm, 25 mm, 35 mm, 50 mm, 75 mm ³³), Evetar (50 mm ³³)
34 mm	Evetar (6 mm, 75 mm ³³)

³³ The filter is not compatible with the sealed lens cover when installed on this lens.

Size	Lens Option
35.5 mm	Kowa (12 mm, 16 mm, 25 mm, 35 mm) ³⁴
43 mm	Computar (5 mm)
46 mm	Kowa (75 mm) ³³
55 mm	Kowa (8 mm) ³³



Important: These filters are for the C-mount lens only. Depending on the lighting technique used, a polarizing filter may be needed for both the lens and the light source. See www.bannerengineering.com for Banner's selection of light filters.

17.5 Sealed Lens Cover

When used, the optional sealed lens covers offer an IP67 rating for the sensor for wet or dirty environments. The cover is painted black aluminum.

The following sealed lens covers are compatible with all WVGA, 1.3 MP, and 2 MP models with lenses installed. The sealed lens covers are compatible with some 5 MP models with lenses installed.

Model	Length	Material	Window Material
VELC60-PC ³⁵	60 mm	Painted aluminum	Polycarbonate
VELC60-BG ³⁵			Borosilicate glass
VELC85-PC ³⁶	85 mm		Polycarbonate
VELC85-BG ³⁶			Borosilicate glass

17.6 Display Cover

Use the Display Cover to protect the display and buttons from the elements.

VEDC-BG

- Painted anodized aluminum with borosilicate glass window
- Mounting hardware included

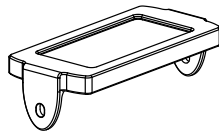

17.7 Ring Lights

For additional ring light information, see the following:

- p/n 192656 for standard lights
- p/n 192657 for high intensity lights
- p/n 208788 for sealed ring lights

and . Additional (standalone) lights are available. See www.bannerengineering.com.

Due to the size of the 5 MP lenses, a ring light cannot be mounted to the 5 MP camera and lens. However, they can be mounted nearby, connected to and controlled by the camera.

³⁴ The filter is not compatible with the lens and 60 mm sealed lens cover installed.

³⁵ For 5 MP camera and lens, only compatible with 25 mm and 35 mm focal lengths without a filter installed.

³⁶ For 5 MP camera and lens, compatible with 12 mm to 75 mm focal lengths without filter installed. With filter installed the sealed lens cover is only compatible with 25 mm to 35 mm focal lengths.

Standard Ring Lights

62 × 62 mm Models	80 × 80 mm Models	Color	Connection
LEDIRV62X62M	LEDIRV80X80M	Infrared, 940 nm	300 mm (12 in) cable with a threaded 3-pin Pico-style connector
LEDRRV62X62M	LEDRRV80X80M	Visible red, 630 nm	
LEDWRV62X62M	LEDWRV80X80M	White, all visible	
LEDBRV62X62M	LEDBRV80X80M	Visible blue, 464 nm to 475 nm	
LEDGRV62X62M	LEDGRV80X80M	Visible green, 520 nm to 540 nm	

High Intensity Ring Lights

Model	LED Color	Intensity Adjustment	Connection
LEDRRV70XD5-XM	Visible red, 620 nm to 630 nm	Fixed	300 mm (12 in) cable with a threaded 3-pin Pico-style connector ³⁷
LEDWRV70XD5-XM	White, 5000 K to 8300 K		
LEDBRV70XD5-XM	Visible blue, 465 nm to 485 nm		
LEDGRV70XD5-XM	Visible green, 520 nm to 535 nm		
LEDIRV70XD5-XM	Infrared, 850 nm		
LEDUV395RV70XD5-XM	Ultraviolet, 395 nm		
LEDRRV70XD5-PM	Visible red, 620 nm to 630 nm	Potentiometer	
LEDWRV70XD5-PM	White, 5000 K to 8300 K		
LEDBRV70XD5-PM	Visible blue, 465 nm to 485 nm		
LEDGRV70XD5-PM	Visible green, 520 nm to 535 nm		
LEDIRV70XD5-PM	Infrared, 850 nm		
LEDUV395RV70XD5-PM	Ultraviolet, 395 nm		

High-Intensity Sealed Ring Light

Model	LED Color	Window Construction	Connection
LEDIRV75BM	Infrared, 850 nm ±5 nm	Borosilicate Glass	350 mm (13.8 in) Pico 3-Pin Quick-Disconnect
LEDRRV75BM	Visible red, 625 nm ±5 nm		
LEDBRV75BM	Visible blue, 475 nm ±5 nm		
LEDGRV75BM	Visible green, 525 nm +10 nm/-5 nm		
LEDWRV75BM	Visible white, 6200K +500K/-550K		
LEDIRV75PM	Infrared, 850 nm ±5 nm	Polycarbonate Plastic	
LEDRRV75PM	Visible red, 625 nm ±5 nm		
LEDBRV75PM	Visible blue, 475 nm ±5 nm		
LEDGRV75PM	Visible green, 525 nm +10 nm/-5 nm		
LEDWRV75PM	Visible white, 6200K +500K/-550K		

17.8 Interface Module

For additional interface module information, see p/n 193821.

³⁷ Connects directly to the VE Series smart cameras

VE Series Smart Camera

Models	Trigger	Connections
VESIM-PT	Current Sourcing (PNP)	Two 13-pin Terminals

18 Product Support and Maintenance

18.1 Repairs

Contact Banner Engineering for troubleshooting of this device. **Do not attempt any repairs to this Banner device; it contains no field-replaceable parts or components.** If the device, device part, or device component is determined to be defective by a Banner Applications Engineer, they will advise you of Banner's RMA (Return Merchandise Authorization) procedure.



Important: If instructed to return the device, pack it with care. Damage that occurs in return shipping is not covered by warranty.

18.2 Maintenance

Maintenance tasks include keeping the hardware free of dust and dirt and updating the Vision Manager software and sensor firmware as new versions become available.

18.2.1 Clean the VE

Regularly remove any dust or dirt from the sensor using a soft cloth.

If needed, slightly dampen the cloth with a weak solution of neutral detergent. Avoid getting dirt on the imager (the area behind the lens). If the imager is dirty, use anti-static compressed air to blow off the dust.

18.2.2 Clean the Lens

Regularly remove dust, dirt, or fingerprints from the lens.

Use anti-static compressed air to blow off dust. If necessary, use a lens cloth and lens cleaner or window cleaner to wipe off remaining debris.

18.2.3 Update the Software and Firmware

The current version of Vision Manager software and the device firmware is available for download from www.bannerengineering.com.

18.3 Contact Us

Banner Engineering Corp. headquarters is located at:

9714 Tenth Avenue North
 Minneapolis, MN 55441, USA
 Phone: + 1 888 373 6767

For worldwide locations and local representatives, visit www.bannerengineering.com.

18.4 Banner Engineering Corp Limited Warranty

Banner Engineering Corp. warrants its products to be free from defects in material and workmanship for one year following the date of shipment. Banner Engineering Corp. will repair or replace, free of charge, any product of its manufacture which, at the time it is returned to the factory, is found to have been defective during the warranty period. This warranty does not cover damage or liability for misuse, abuse, or the improper application or installation of the Banner product.

THIS LIMITED WARRANTY IS EXCLUSIVE AND IN LIEU OF ALL OTHER WARRANTIES WHETHER EXPRESS OR IMPLIED (INCLUDING, WITHOUT LIMITATION, ANY WARRANTY OF MERCHANTABILITY OR FITNESS FOR A PARTICULAR PURPOSE), AND WHETHER ARISING UNDER COURSE OF PERFORMANCE, COURSE OF DEALING OR TRADE USAGE.

This Warranty is exclusive and limited to repair or, at the discretion of Banner Engineering Corp., replacement. **IN NO EVENT SHALL BANNER ENGINEERING CORP. BE LIABLE TO BUYER OR ANY OTHER PERSON OR ENTITY FOR ANY EXTRA COSTS, EXPENSES, LOSSES, LOSS OF PROFITS, OR ANY INCIDENTAL, CONSEQUENTIAL OR SPECIAL DAMAGES RESULTING FROM ANY PRODUCT DEFECT OR FROM THE USE OR INABILITY TO USE THE PRODUCT, WHETHER ARISING IN CONTRACT OR WARRANTY, STATUTE, TORT, STRICT LIABILITY, NEGLIGENCE, OR OTHERWISE.**

Banner Engineering Corp. reserves the right to change, modify or improve the design of the product without assuming any obligations or liabilities relating to any product previously manufactured by Banner Engineering Corp. Any misuse, abuse, or improper application or installation of this product or use of the product for personal protection applications when the product is identified as not intended for such purposes will void the product warranty. Any modifications to this product without prior express approval by Banner Engineering Corp will void the product warranties. All specifications published in this document are subject to change; Banner reserves the right to modify product specifications or update documentation at any time. Specifications and product information in English supersede that which is provided in any other language. For the most recent version of any documentation, refer to: www.bannerengineering.com.

For patent information, see www.bannerengineering.com/patents.

Index

1D barcode 139
2D barcode 141, 142

A

absolute threshold
 edge profile 100, 115, 133
 value 99, 115, 133
Active Sensors tab 24
adaptive threshold
 bead type 66, 82
 blob type 66, 82
administrator 55
All Results 32
area 86
area range 83
auto exposure 57
Auto Learn 139
Average Gray tool
 test parameters 63
 input parameters 61–63
 results 64
 using 64

B

backup 26, 27, 164
bandwidth 40
barcode
 1D 139
 2D 141, 142
 Auto Learn 139
 Codabar 139
 Code 128 139
 Code 39 139
 Code 93 139
 Data Matrix 141, 142
 DataBar 139
 EAN-13 (UPC-A) 139
 EAN-8 139
 ECC200 141, 142
 IMb 143
 Intelligent Mail 143
 Interleaved 2 of 5 139
 max count 139
 PDF417 139
 Pharmacode 139
 postal 143
 POSTNET 143
 QR 141, 142
 UPC-E 139

Barcode tool
 input parameters 138, 139,
 141–144
 results 146
 ROI 138
 test parameters 145
 using 146

Bead tool
 bead width 68
 filters 68
 input parameters 65–69
 results 70
 ROI 65, 71
 test parameters 70
 using 73
bead type
 adaptive threshold 66, 82
 fixed threshold 67
Blemish tool
 input parameters 76–78
 results 79
 test parameters 78
 using 79
blob statistics 83
Blob tool
 input parameters 81–85
 results 85–87, 89
 statistics 83
 test parameters 85
 using 89
blob type
 adaptive threshold 66, 82
 fixed threshold 67
bracket 256
buttons
 lock 165

C

calibration 46, 47, 50, 51
Camera tool
 results 60
 using 57–60
centroid 86
characteristics
 Measure tool 155
Circle Detect tool
 input parameters 91–94
 results 95
 test parameters 94
 using 96
Codabar 139
Code 128 139
Code 39 139
Code 93 139
communications 40–44
compactness 87
copy 21, 35
cordset 256
cover
 lens 260
CRC
 inspection 34–37
 system 37
Cyclic Redundancy Check
 , See CRC

D

DAP 217
data export
 settings 43
Data Matrix 141, 142
data model 217
DataBar 139
decimal places 53
delete
 inspection 21, 35
 tool 21
 tool and tools after 21
Device Access Point
 , See DAP
device control 220
discrete I/O
 configure 22
display 165–168
DISPLAY 168
display menu 168
duplicate 21

E

EAN-13 (UPC-A) 139
EAN-8 139
ECC200 141, 142
eccentricity 89
edge length range
 Blemish tool 77
edge polarity 92, 99–101, 108,
 114–116
edge profile
 absolute threshold 100, 115,
 133
 edge strength threshold 102,
 116, 134
 relative threshold 101, 114, 132
edge strength threshold
 edge strength 101, 115, 133
Edge tool
 input parameters 98–103
 results 104
 test parameters 104
 using 105, 157
emulator
 backup 27, 164
 restore 27, 164
ETHER 167
Ethernet
 communications 176
 settings 40
EtherNet/IP 42
export
 system logs 45
exposure
 auto 57
external strobe 59

F

- factory default 56
- Favorites tab
 - add 24
 - remove 24
- filters
 - Bead tool 68
 - blob tool 83
 - Edge tool 102
 - lens 13, 259
 - Locate tool 116
 - Object tool 134
- firmware
 - update 25
 - version 25, 26
- fixed threshold
 - bead type 67
 - blob type 67
- focus information 59

G

- gain 57
- General Station Description
 - , See GSD
- grade 143
- GSD
 - Install 226

H

- histogram
 - , See tool histogram
- Home screen 23–28

I

- I/O
 - discrete 38, 39
 - summary 30
- IMAGE 167
- image export
 - ftp 173
 - settings 44
 - TCP/IP 171
- image menu 167
- image overlays 62, 68, 77, 84, 93, 103, 109, 117, 125, 135, 144, 155
- imager 57
- IMb 143
- indicators, LED 8
- Industrial Protocols 42
- INFO 167
- information menu 167
- input string
 - settings 44
- Input/Output 167
- inspection
 - begin at startup 36
 - copy 35
 - CRC 34–37

- delete 21, 35
- manage 35, 36
- modify 21
- name 20
- save 20, 36, 37
- set up 18–21
- summary 29
- transfer 36, 37
- Inspection Logs
 - sources 33
- Inspection Logs screen 33, 34
- Inspection Management screen 34–37
- inspection results 219
- Intelligent Mail 143
- interface 165
- interface module 261
- Interleaved 2 of 5 139
- IO 167

L

- language
 - selection of 28
- lens
 - 1.3 MP 258
 - 2 MP 258
 - 5 MP 259
 - cover 13, 260
 - filter 13, 259
 - WVGA 257
- light
 - ring 13, 260
- Line Detect tool
 - input parameters 107–109
 - results 110
 - ROI 107
 - Search For 108
 - test parameters 110
 - using 111
- Locate tool
 - input parameters 112–118
 - results 119
 - test parameters 118
 - using 120
- Logic tool
 - input parameters 160, 161
 - results 161
 - test parameters 161
 - using 162
- logs
 - inspection 33, 34
 - system logs 45

M

- major axis angle 87
- major axis length 87
- Manage 35, 36
- mask
 - add 62, 66, 76, 81
 - delete 62, 66, 76, 81

Match tool

- input parameters 123–126
- remote TEACH 130
- results 127
- test parameters 126
- using 128

Math tool

- input parameters 149–151
- operand A 150
- operand B 151
- operator 149
- results 151
- test parameters 151
- using 152

- max barcode count 139

- max radius 89

- max radius position 89

- measure from 155

- measure to 155

Measure tool

- characteristics 155
- input parameters 154–156
- measure from 155
- measure to 155
- results 157
- test parameters 156

- min radius 89

- min radius position 89

- minor axis length 87

- Modbus/TCP 42

- models 6

N

- Network Adapters tab 25

O

Object tool

- input parameters 130–135
- results 136
- test parameters 136
- using 137

- object type 132–134

- operand 149, 159

- operand A 150

- operand B 151

- operation 149

- operator 149

- operator1 55

- operator2 55

P

- password 54, 55

Password

- change 55

pattern

- Match tool 124

- PC Requirements 10

- PCCC 42

- PCHANGE 167

- PDF417 139

- percent
 - relative threshold 100, 114, 132
- percent match 124
- perimeter 86
- Pharmacode 139
- pixel intensity range 62
- postal barcode 143
- POSTNET 143
- precision 53, 125
- preferences 28
- product change 167
- PROFINET 42, 217–220, 224–226, 228, 231, 234

Q

- QR 141, 142

R

- reboot 56
- REBOOT 168
- reboot menu 168
- reject level 67, 82
- relative threshold
 - edge profile 101, 114, 132
 - percent 100, 114, 132
- remote TEACH
 - Barcode tool 145
 - Match tool 130
- reset 56
- restore 26, 27, 164
- results
 - Average Gray tool 64
 - Barcode tool 146
 - Bead tool 70
 - Blemish tool 79
 - Blob tool 85–87, 89
 - Camera tool 60
 - Circle Detect tool 95
 - Edge tool 104
 - Line Detect tool 110
 - Locate tool 119
 - Logic tool 161
 - Match tool 127
 - Math tool 151
 - Measure tool 157
 - Object tool 136
- ring light 13, 260
- ROI (Region of Interest)
 - Barcode tool 138
 - Bead tool 65, 71
 - Line Detect tool 107
 - search 123
 - teach 124
- rotation range 124

S

- save 20, 36, 37
- scale units 47
- scaling 47

- screen
 - Home 23–28
 - Inspection Logs 33, 34
 - Inspection Management 34–37
 - Sensor 28–32
 - System Settings 37–47, 50, 51, 53–56
- Search For 108
- search ROI 123
- sensitivity 77
- sensor
 - backup 26
 - boot count 37
 - firmware version 37
 - gateway 37
 - hour count 37
 - IP address 37
 - MAC address 37
 - menu 166
 - model number 37
 - name 37
 - reset 56
 - restore 26
 - serial number 37
 - subnet mask 37
- Sensor Maintenance 25, 26
- Sensor Neighborhood 24, 25
- Sensor screen 28–32
- serial 41
- software
 - information 28
 - version number 28
 - Vision Manager 9
- strobe
 - external 59
- submodule description 219, 220, 224, 225
- supported submodules 219, 220, 224, 225
- symbol grade 143
- SYSERR 168
- system CRC 37
- system error menu 168
- System Settings screen 37–47, 50, 51, 53–56

T

- tab
 - About 28
 - Active Sensors 24
 - All Results 32
 - Favorites 24
 - Network Adapters 25
 - Tools & Results 31
 - Tools Only 32
- TEACH
 - , See remote TEACH
- teach ROI 124
- test
 - Average Gray tool 63
 - Barcode tool 145

- Bead tool 70
- Blemish tool 78
- Blob tool 85
- Circle Detect tool 94
- Edge tool 104
- Line Detect tool 110
- Locate tool 118
- Logic tool 161
- Match tool 126
- Math tool 151
- Measure tool 156
- Object tool 136
- summary 31

threshold

- absolute 99, 100, 114, 115, 132, 133
- adaptive 66, 67, 82
- edge polarity 92, 99–101, 108, 114–116
- edge strength 101, 102, 115, 116, 133, 134
- fixed 67, 83
- object type 132–134
- reject level 67, 82
- relative 100, 101, 113, 114, 131, 132

timeout 125, 143

tool

- add 18
- Average Gray 61–64
- Barcode 138, 139, 141–146
- Bead 65–71, 73
- Blemish 75–79
- Blob 80–87, 89
- Circle Detect 91–96
- copy 21
- delete 21
- delete tool and after 21
- Edge 98–105
- Line Detect 106–111
- Locate 112–120
- Logic 159–162
- Match 122–128, 130
- Math 149–152
- Measure 153–157
- Object 130–137
- rename 19
- tool histogram 63, 69, 78, 84, 93, 103, 109, 118, 126, 135, 144
- Tools & Results 31
- Tools Only 32
- Transfer 36, 37
- trigger 58
- trigger mode 177

U

- units 46, 47, 50, 51
- UPC-E 139
- use as reference 117, 125
- user 54, 55

User

- add 54
- user name 55
- user name 55
- user profile 54, 55
- user profiles

- profiles 55
- users 54, 55
- username 54, 55

V

- Vision Manager
 - about 28
 - version number 28